

5GIF

# FINAL Evaluation Report from 5G India Forum Independent Evaluation Group

Revision 3.7

# Part I

Name of the Evaluation Group: 5G India Forum (5GIF)

## About the IEG

5G India Forum (5GIF) has been established under the aegis of the Cellular Operators Association of India (COAI), aiming to become the leading force in the development of next generation communications and will enable synergizing national efforts and will play a significant role in shaping the strategic, commercial and regulatory development of the 5G ecosystem in India.

5GIF is one of the registered as Independent Evaluation Group (IEG) for contributing to IMT-2020 development of ITU-R through independent evaluation of the IMT2020 candidate technologies. This group was formed by the COAI to evaluate the IMT-2020 candidates from the perspective of Indian network deployments.

This is a group of operators, OEM's, universities and individual experts participating in a collaborative manner, in the evaluation of the candidate IMT-2020 technologies of interest. This is a contribution driven activity, with decisions made through a consensus seeking approach.

## Method of Work

The 5GIF IEG is a collection of operators, industry and university members, knowledgeable on the subject matter, and committed to the IMT 2020 evaluation. Over 30 individuals have contributed to the evaluation process. The group employed both online and offline means for meetings. This group was formed to evaluate the IMT 2020 candidates from the perspective of Indian network deployments. The group worked through online and offline means, while strictly adhering to the ITU processes, and sincerely focuses on consensus-based decision making.

Two industry workshops were facilitated by COAI, which discussed the candidate technologies of interest. A special 48-hour hackathon with mentorship provide by industry experts helped our members get involved actively, especially those joining us from academia. The 5GIF IEG has had five workshops to help in deliberation and consensus building. We have a robust mechanism in place to track the evaluation progress and ensure that the ITU timelines are adhered to.

The 5GIF IEG has submitted an interim report for the WP5D#33 meeting. We also participated in the ITU-R WP 5D Evaluation Workshop on December 10 and 11, 2019 held on the side-lines of this meeting. At that workshop we presented initial results, and our plans for the final evaluation. We also interacted with other IEG's on the evaluation during the time between meetings #33 and #34.

## Contact details:

### **Vikram Tiwathia**

Deputy Director General, COAI

Email: [vtiwathia@coai.in](mailto:vtiwathia@coai.in)

Telephone: +91-11-2334-9275

### **Technical contact**

Email: [imt2020@5gindiaforum.in](mailto:imt2020@5gindiaforum.in)

<https://5gif.github.io>

## Acknowledgements

The individual members listed below are acknowledged for their valuable contribution to the 5GIF IEG IMT-2020 evaluation activity.

Sl. No.	Name	Affiliation
1	Akhil Bachkaniwala, Mr.	LNMIIT Univ.
2	Aritri Debnath, Ms.	Amrita Univ.
3	Aryan Sharma, Mr.	Amity Univ.
4	Ashwani Kumar, Mr.	Huawei India
5	Divyang Rawal, Prof.	LNMIIT Univ.
6	Goli Srikanth, Mr.	Shiv Nadar Univ.
7	Jayant Moghe, Mr.	Vodafone Idea
8	Laxmi Sharma, Ms.	Amrita Univ.
9	Madhur Bharadwaj, Mr.	Bharti Airtel
10	Monika Singh, Ms.	Amrita Univ.
11	Munish Bharadwaj, Mr.	Bharti Airtel
12	Mynampati Meghana, Ms.	Amrita Univ.
13	Navin Kumar, Prof.	Amrita Univ.
14	Niranth Amogh, Mr.	Huawei India
15	Phanikumar Reddy, Mr.	Qualcomm India
16	Pournamy S, Ms.	Amrita Univ.
17	Priya Nair, Ms.	Amrita Univ.
18	Punit Rathod, Dr.	Intel India
19	Rahul Makkar, Mr.	LNMIIT Univ.
20	Ruhi Kumari, Ms.	LNMIIT Univ.
21	Sakala Sai Charan, Mr.	LNMIIT Univ.
22	Sandhya Soni, Ms.	LNMIIT Univ.
23	Sankararaman Krishnan, Mr.	LNMIIT Univ.
24	Sendil Devar, Dr.	Ericsson India
25	Sheeba Kumari M, Ms.	Amrita Univ.
26	Sujata Pandey, Dr.	Amity Univ.
27	Sri Sai Apoorva T, Ms.	Amrita Univ.
28	Srikar Gadepalli, Mr.	Shiv Nadar Univ.
29	Srinivasan Selvaganapathy, Mr.	Nokia India
30	Venugopalachary, Mr.	Shiv Nadar Univ.
31	Vijaykumar Chakka, Prof.	Shiv Nadar Univ.
32	Vikram Tiwathia, Mr.	COAI
33	Vinosh Babu James, Dr.	Qualcomm India
34	Vishakha Dhanwani, Ms.	LNMIIT Univ.
35	Vishal Sangal, Mr.	ZTE India

# Part – II

## Technical Report

This part of the report covers the technical aspects of the evaluation report. This document is the final evaluation report of the 3GPP RIT candidate technology (IMT-2020/14). In this report, we have evaluated the 3GPP NR technology and refers the various information from the corresponding 3GPP specifications (as provided by the proponents) in their ITU-R submissions and self-evaluation reports submitted by 3GPP with respect to the IMT-2020/14.

This evaluation is also applicable to other candidate technologies (IMT-2020/13<sup>1</sup>, IMT-2020/15, IMT-2020/16 and IMT-2020/17<sup>2</sup>) that are technically identical to the 3GPP NR RIT (IMT-2020/14), as identified by WP5D in WP5D-32bis (Buzios) of step-3.

### A. Candidate technologies or portions Evaluated by IEG

The 5GIF IEG is supported by the COAI, and its members have interest in 3GPP based technologies. We had a small group of motivated engineers, who participated in all aspects of evaluation. One of the objectives was to build an industry grade simulator that can be then leveraged for future studies. In that aspect, we focused on building a 3GPP NR simulator, including signalling support. With that stated objective, we pursued the evaluation of technologies that are entirely based on 3GPP RIT candidate (IMT-2020/14). With the inclusion of NB-IoT defined in 3GPP SRIT (IMT-2020/13), we could undertake the assessment of the technologies listed in the table below.

IMT-2020 SUBMISSION						
3GPP		CHINA	KOREA	TSDSI	ETSI (TC DECT), DECT FORUM	Nufront
RIT	SRIT					
IMT-2020/14	IMT-2020/13	IMT-2020/15	IMT-2020/16	IMT-2020/19	IMT-2020/17	IMT-2020/18
✓	✓*	✓	✓		✓*	✓*

\* Partial evaluation

Candidate technology IMT-2020/13 used LTE-Advanced Pro for the eMBB candidate, which was not evaluated by the 5GIF. The candidate technology DECT 2020 NR in IMT-2020/17, and candidate technology EUHT in IMT-2020/18 are only partly evaluated by us. They had both cleared Step-3 of the IMT-2020 process only at the WP5D#33 meeting. However, these partial evaluations allow us to make a recommendation on these technologies as well.

The 5GIF IEG utilized the ITU-R Guidelines for evaluation of radio interface technologies for IMT-2020 provided in ITU-R Report [M.2412](#). The 5GIF IEG also provides some supplementary evaluation in Sec. 2.2.3.1-B.

<sup>1</sup> 3GPP NR RIT is a component RIT of the SRIT in IMT-2020/13

<sup>2</sup> 3GPP NR RIT is the eMBB component of IMT-2020/17



## Summary table of the IMT-2020 candidate technology submissions

RIT/SRIT Proponent	Submission of Documents & Acknowledgement of Submission (IMT-2020/YYY)	Observations of SWG Evaluation
<b>3GPP (SRIT)</b>	<b>Submissions <u>IMT-2020/3 (Rev.4)</u></b> Proposals of candidate radio interface technologies from proponent '3GPP' under step 3 of the IMT-2020 process	<u>IMT 2020/23</u>
	<b>Acknowledgement <u>IMT-2020/13</u></b> Acknowledgement of candidate SRIT submission from 3GPP Proponent under Step 3 of the IMT-2020 process	Observations of IMT-2020 submission in Documents 5D/1215, 5D/1216 and 5D/1217
<b>3GPP (RIT)</b>	<b>Submissions <u>IMT-2020/3 (Rev.4)</u></b> Submission received for proposals of candidate radio interface technologies from proponent '3GPP' under step 3 of the IMT-2020 process	<u>IMT 2020/23</u>
	<b>Acknowledgement <u>IMT-2020/14</u></b> Acknowledgement of candidate RIT submission from 3GPP Proponent Step 3 of the IMT-2020 process	Observations of IMT-2020 Submission in Documents 5D/1215, 5D/1216 and 5D/1217
<b>China (People's Republic of)</b>	<b>Submissions <u>IMT-2020/5 (Rev.4)</u></b> Submission received for proposals of candidate radio interface technologies from proponent 'China' under Step 3 of the IMT-2020 process	<u>IMT-2020/24</u>
	<b>Acknowledgement <u>IMT-2020/15</u></b> Acknowledgement of candidate RIT submission from China (People's Republic of) under Step 3 of the IMT-2020 process	Observations of IMT-2020 submission in Document 5D/1268 (Proponent China)
<b>Korea (Republic of)</b>	<b>Submissions <u>IMT-2020/4 (Rev.4)</u></b> Submission received for proposals of candidate radio interface technologies from proponent 'Korea (Rep. of)' under Step 3 of the IMT-2020 process	<u>IMT-2020/25</u>
	<b>Acknowledgement <u>IMT-2020/16</u></b> Acknowledgement of candidate RIT submission from Korea (Republic of) under Step 3 of the IMT-2020 process	Observations of SWG Evaluation - IMT-2020 submission in Document 5D/1233 (Proponent Korea)
<b>ETSI (TC DECT) and DECT Forum</b>	<b>Submissions <u>IMT-2020/6 (Rev.4)</u></b> Submission received for proposals of Candidate Radio Interface Technologies from Proponent 'ETSI' and 'DECT Forum' under step 3 of the IMT-2020 process	<u>IMT-2020/26 (Rev.1)</u>
	<b>Acknowledgement <u>IMT-2020/17 (Rev.1)</u></b> Acknowledgement of candidate SRIT submission from ETSI (TC DECT) and DECT Forum under Step 3 of the IMT-2020 process	Observations of SWG Evaluation - IMT-2020 submission in Documents 5D/1299, 5D/1230 and 5D/1253 (Proponents ETSI (TC DECT) & DECT Forum)
<b>Nufront</b>	<b>Submissions <u>IMT-2020/12 (Rev.1)</u></b> received for proposals of candidate radio interface technologies from proponent 'Nufront' under step 3 of the IMT-2020 process	<u>IMT-2020/27 (Rev.1)</u>
	<b>Acknowledgement <u>IMT-2020/18 (Rev.1)</u></b> Acknowledgement of candidate RIT submission from Nufront under Step 3 of the IMT-2020 process	Observations of SWG Evaluation - IMT-2020 submission in Document 5D/1300 (Proponent Nufront)
<b>TSDSI</b>	<b>Submissions <u>IMT-2020/7(Rev.4)</u></b> Submission received for proposals of candidate radio interface technologies from proponent 'TSDSI' under Step 3 of the IMT-2020 process	<u>IMT-2020/28 (Rev.1)</u>
	<b>Acknowledgement <u>IMT-2020/19 (Rev.1)</u></b> Acknowledgement of candidate RIT submission from TSDSI under Step 3 of the IMT-2020 process	Observations of SWG Evaluation - IMT-2020 submission in Document 5D/1301 (Proponent TSDSI)

## B. Confirmation of utilization of the ITU-R evaluation guidelines in Report ITU-R M.2412;

The 5GIF IEG confirms that it has evaluated the candidate technologies as well as evaluated the submissions from proponents based on the Reports ITU-R M.2410, ITU-R M.2411 and ITU-R M.2412.

Characteristic for evaluation	High-level assessment method	Evaluation methodology (M.2412)	Related section of Reports ITU-R M.2410-0 and ITU-R M.2411-0
Peak data rate	Analytical	§ 7.2.2	Report ITU-R M.2410-0, § 4.1
Peak spectral efficiency		§ 7.2.1	Report ITU-R M.2410-0, § 4.2
User experienced data rate*		§ 7.2.3	Report ITU-R M.2410-0, § 4.3
Area traffic capacity		§ 7.2.4	Report ITU-R M.2410-0, § 4.6
User plane latency		§ 7.2.6	Report ITU-R M.2410-0, § 4.7.1
Control plane latency		§ 7.2.5	Report ITU-R M.2410-0, § 4.7.2
Mobility interruption time		§ 7.2.7	Report ITU-R M.2410-0, § 4.12
Energy efficiency	Inspection	§ 7.3.2	Report ITU-R M.2410-0, § 4.9
Bandwidth		§ 7.3.1	Report ITU-R M.2410-0, § 4.13
Support of wide range of services		§ 7.3.3	Report ITU-R M.2411-0, § 3.1
Supported spectrum band(s)/range(s)		§ 7.3.4	Report ITU-R M.2411-0, § 3.2
Average spectral efficiency	Simulation	§ 7.1.1	Report ITU-R M.2410-0, § 4.5
5 <sup>th</sup> percentile user spectral efficiency		§ 7.1.2	Report ITU-R M.2410-0, § 4.4
Connection density		§ 7.1.3	Report ITU-R M.2410-0, § 4.8
Reliability		§ 7.1.5	Report ITU-R M.2410-0, § 4.10
Mobility		§ 7.1.4	Report ITU-R M.2410-0, § 4.11

## C. Documentation of any additional evaluation methodologies that are or might be developed by the Independent Evaluation Group to complement the evaluation guidelines

Not applicable.

## D. Verification as per Report ITU-R M.2411 of the compliance templates and the self-evaluation for each candidate technology as indicated in A).

Aspects	3GPP, China, Korea	DECT	NuFront	TSDSI
	Sections in <u>Chapter 1</u>			
1) Identify gaps/deficiencies in submitted material and/or self-evaluation;	Refer Sec. 1.1	Refer Sec. 1.2	Refer Sec. 1.3	Refer Sec. 1.4
2) Identify areas requiring clarifications;				

3) General Questions to Proponents			Questions were posted to the forum (Refer Annex J.3)	
------------------------------------	--	--	--	--

### E. Assessment as per Reports ITU-R M.2410, ITU-R M.2411 and ITU-R M.2412 for each candidate technology as indicated in A)

Aspects	3GPP, China, Korea	DECT	Nufront
Detailed analysis/assessment and evaluation by the IEGs of the compliance templates submitted by the proponents per the Report ITU-R M.2411 section 5.2.4;	Chapter 2	Chapter 3	Chapter 4
Provide any additional comments in the templates along with supporting documentation for such comments;	Section 2.1.4		
Analysis of the proponent's self-evaluation by the IEG;	Evaluated to be complete (Sec 2.4)		

### F. Questions and feedback to WP 5D and/or the proponents or other IEGs

We would like to thank WP5D and 3GPP for hosting the workshops on IMT-2020. This understanding of the 3GPP technology has given us confidence in independently evaluating their submissions.

We also would like to bring to the notice of WP5D that though the reports M.2412 has sufficient guidelines for evaluating the candidate technology, we had few challenges in evaluating technologies which completely relied on MESH based network to communicate. We request WP5D to consider inclusion of such aspects in the methodologies in future reports.

We also request WP5D to update the rural path-loss models in M.2412 through appropriate studies. We are currently of the opinion that the current model cannot be widely applied to any rural environments.

We noticed that one of the questions in the Description template is about interoperability of a candidate with other IMT technology as well as other candidate technologies. It will be helpful if the proponents share the details or existing specifications that enables such inter-operability. Some such communications are as below:

1. [SP-180683](#) - LS from ETSI TC DECT: Interworking of DECT technology with 3GPP networks
2. [SP-180924](#) - Reply LS to ETSI TC DECT on Interworking of DECT technology with 3GPP networks

# Table of Contents

<b>1. Verification of Compliance Templates of candidate Technologies .....</b>	<b>11</b>
1.1 Candidate technologies – IMT-2020/13 & /14, IMT-2020/15, IMT-2020/16 .....	11
1.1.1 Observations on gaps identified.....	11
1.1.2 Request for Clarifications.....	11
1.2 Candidate technology - DECT-Forum IMT-2020/17.....	11
1.2.1 Observations on gaps identified.....	12
DESCRIPTION TEMPLATES (5.2.3.2, M.2411) .....	12
COMPLIANCE TEMPLATES (5.2.3.2, M.2411) .....	12
1.3 Candidate technology - IMT-2020/18 .....	14
1.4 Candidate technologies - IMT-2020/19.....	16
<b>2. Assessment of Candidate technology by 3GPP –RIT (IMT-2020/14) &amp; SRIT (IMT-2020/13) .....</b>	<b>17</b>
2.1 Compliance Templates .....	17
2.1.1 Services .....	17
2.1.2 Spectrum .....	18
2.1.3 Technical Performance.....	20
2.1.4 Link Budget Templates .....	25
2.2 Detailed Technical Evaluation .....	26
2.2.1 Analysis Aspects.....	26
2.2.1.1 PEAK SPECTRAL EFFICIENCY .....	26
2.2.1.2 PEAK DATA RATE.....	31
2.2.1.3 USER EXPERIENCED DATA RATE .....	33
2.2.1.4 AREA TRAFFIC CAPACITY .....	37
2.2.1.5 CONTROL PLANE LATENCY .....	38
2.2.1.6 USER PLANE LATENCY.....	43
2.2.1.7 MOBILITY INTERRUPTION TIME.....	47
2.2.2 Inspection Aspects .....	48
2.2.2.1 BANDWIDTH .....	48
2.2.2.2 ENERGY EFFICIENCY.....	50
2.2.2.3 SUPPORT OF WIDE RANGE OF SERVICES .....	52
2.2.2.4 SUPPORTED SPECTRUM BAND(S)/RANGE(S) .....	53
2.2.3 Simulation Aspects .....	56
2.2.3.1-A SPECTRAL EFFICIENCY .....	56
2.2.3.1-B SPECTRAL EFFICIENCY - SUPPLEMENTARY EVALUATION.....	67
2.2.3.2 CONNECTION DENSITY.....	72
NB-IoT.....	74
2.2.3.3 MOBILITY.....	77
2.2.3.4 RELIABILITY.....	82
2.3 Similarity with other Candidate Technologies.....	93
2.3.1 Commonality of the eMBB component.....	93
2.3.2 The Non-standalone (NSA) mode.....	94
2.3.3 Idle/Inactive mode behaviour and Initial Access Process.....	94
2.4 Conclusion.....	97
<b>3. Assessment of Candidate technology – DECT FORUM (IMT2020/17) .....</b>	<b>98</b>
3.1 COMPLIANCE TEMPLATES.....	98
3.1.1 Services.....	98
3.1.2 Spectrum .....	98
3.1.3 Technical Performance.....	99
3.2 DETAILED TECHNICAL EVALUATION.....	103

3.2.1 ANALYSIS ASPECTS.....	103
3.2.1.1 USER PLANE LATENCY.....	103
3.2.1.2 CONTROL PLANE LATENCY.....	105
3.2.2 INSPECTION ASPECTS.....	108
3.2.2.1 BANDWIDTH.....	108
3.2.2.3 SUPPORTED SPECTRUM BANDS(s)/RANGE(s).....	108
3.2.3 SIMULATION ASPECTS.....	109
<b>3.3 CONCLUSION.....</b>	<b>114</b>
<b>4. Assessment of candidate technology – EUHT (IMT-2020/18).....</b>	<b>116</b>
4.1 Compliance Templates.....	116
4.1.1 Services.....	116
4.1.2 Spectrum.....	116
4.1.3 Technical Performance.....	118
4.2 Detailed Technical Evaluation.....	122
4.2.1 Analysis Aspects.....	126
4.2.1.1 Peak Spectral Efficiency.....	126
4.2.1.3 User experienced data rate.....	132
4.2.1.4 Area traffic capacity.....	135
4.2.1.5 Mobility Interruption Time.....	136
4.2.2 Inspection Aspects.....	138
4.2.2.1 Bandwidth.....	138
4.2.3 Simulation Aspects.....	139
4.2.3.1 SPECTRAL EFFICIENCY.....	139
4.2.3.2 Reliability.....	157
4.3 Conclusion.....	162
<b>5. Annexures.....</b>	<b>163</b>
A. Evaluation model for non-full buffer system level simulation for NB-IoT.....	163
A.1 Procedure and delay modeling.....	163
A.2 Evaluation method of full system level simulation.....	163
A.3 Delay Modeling of Step 1: Sync + MIB.....	163
A.3.1 Synchronization delay.....	164
A.3.2 PBCH receiving delay.....	164
A.4 Delay Modeling of Step 2: PRACH Msg1.....	164
A.5 Delay Modeling of Step 3: NPDCCH + RAR (including UL grant).....	166
A.5.1 Scheduling scheme of NPDCCH and RAR.....	166
A.5.2 NPDCCH delay.....	166
A.5.3 RAR delay.....	167
A.6 Delay Modeling of Step 4: UL data.....	167
A.7 DL and UL resource occupation model for Step 5 and Step 6.....	168
A.7.1 DL resource occupation for Step 5: RRC Early Data Complete.....	168
A.7.2 UL resource occupation for Step 6: HARQ Ack.....	168
B. System-level simulation assumptions of mMTC.....	169
B.1. Simulation assumption for mMTC.....	169
B.2 Simulation assumption for NB-IoT.....	169
B.3 Simulation assumption for NR.....	170
C. Link level simulation assumption for mMTC.....	171
D. SINR distribution of full buffer system level simulation (mMTC evaluation).....	172
E. Spectrum efficiency from link-level simulation (mMTC Evaluation).....	173
F. CDF for ZoD spread for LOS and NLOS (mobility evaluation).....	174
G. Simulation assumption of SLS part for mobility evaluation.....	176
H. Simulation assumption of LLS part for mobility evaluation.....	178

<i>I. SLS Results:</i> .....	178
I.1 Pathloss Model.....	179
<i>J. EUHT</i> .....	185
J.1 Analysis on channel coding design .....	185
J.2 Questions.....	191
<i>K. Scenarios and Configurations as per ITU-R M.2412</i> .....	192

## 1. Verification of Compliance Templates of candidate Technologies

In this chapter, we have reported our observations on the submissions of the candidate technologies at the end of step 3 of the IMT-2020 process. We referred the final submissions from 3GPP, China and Korea (IMT-2020/14 & /13, IMT-2020/15 & IMT-2020/16) which cleared step 3 during the WP5D#32 meeting at Brazil.

For the other candidate technologies from DECT, Nufront and TSDSI (IMT-2020/17, IMT-2020/18 & IMT-2020/19) we referred their revised submission approved in WP5D#34 meeting.

This chapter verifies the following aspects like – gaps and deficiencies in the templates – link budget, characteristic and compliance templates as well as ambiguous parts of the submissions which needs sufficient clarifications from the proponents so as to independently evaluate the technology as per M.2412 recommendations.

### 1.1 Candidate technologies – IMT-2020/13 & /14, IMT-2020/15, IMT-2020/16 *Proponents: 3GPP, China & Korea*

The WP5D at their 32<sup>nd</sup> meeting in Buzios declared that the candidate submissions from 3GPP, China and Korea have cleared Step-3 of the IMT-2020 process. The 3GPP RIT submission documented in IMT-2020/14 is based on the NR radio interface technology, and the 3GPP SRIT submission in IMT-2020/13 is based on LTE-Advanced Pro, which includes the NB-IoT for mMTC. The meeting further documented that the candidate in IMT-2020/16 by Korea is entirely based on the NR technology in IMT-2020/14. And the candidate technology IMT-2020/15 from China is a RIT based on NR and NB-IoT. All these submissions were identified to be complete, and the single evaluation of IMT-2020/13 and IMT-2020/14 should suffice making the recommendation on IMT-2020/15 and IMT-2020/16.

#### 1.1.1 Observations on gaps identified

The 5GIF IEG found the self-evaluation report submitted by the proponents to be complete and sufficient for us to independently evaluate

The 5GIF hereby recommends for this candidate technology to move further in the IMT process, as previously identified by WP5D.

#### 1.1.2 Request for Clarifications

No comments.

### 1.2 Candidate technology - DECT-Forum IMT-2020/17 *Proponent: TC-DECT (ETSI)*

In this chapter, we have included our observations on the verification of the information in the *revised* submission by TC DECT Forum submitted after WP5D#32, Bouzios, Brazil. This final revised submission [5D/1299](#) was discussed during the WP5D#34 meeting.

We attempted to find gaps and clarification of the information needed for evaluation of this technology using their description templates and referred specification and study report (ETSI TR 103 504). We have referred to the assumptions given in the self-evaluation report in [5D/1299](#) and the clarifications during the discussion in SWG Evaluation included in the [IMT2020/26](#).

The DECT RIT contains two component technology – 3GPP NR (for eMBB usage scenarios) based on **IMT-2020/14** that is evaluated in chapter 2 and the DECT2020 NR component which is technically different from 3GPP NR and is the candidate component for meeting the performance requirements for URLLC and mMTC usage scenarios. These observations are related to the DECT2020 NR component.

### 1.2.1 Observations on gaps identified

#### *DESCRIPTION TEMPLATES (5.2.3.2, M.2411)*

i) Spectrum capabilities and duplex technologies

For the DECT-2020 NR component RIT, the proponent has reported that the *Minimum practical spectrum for a contiguous network is assumed is 10 MHz*” whereas **5.2.3.2.8.2** the proponent reported that the DECT-2020 NR component RIT needs *channel bandwidth is scalable and is in multiples of 1.728 MHz*”

**5GIF Comments:** *There is an inconsistency about the system bandwidth of the DECT2020 NR component.*

ii) Support of Advanced antenna capabilities

The proponent has reported that *“For self-evaluation system simulations omni directional FP antenna constellations where used. Additionally, for mMTC system simulations antenna height has been reduced in self-evaluation simulations to 5 meters, to support low cost easy site deployments”*.

**5GIF Comments:** It seems like this RIT component is limited to Omni-direction antenna only and may not be possible to deploy using multiple sectors and active antenna systems.

#### *COMPLIANCE TEMPLATES (5.2.3.2, M.2411)*

i) Support of IMT bands

**5GIF Comments**

The submission by DECT describes that the DECT 2020 NR supports various IMT bands, but the specification/report lists the carrier frequency numbers only for the range 1880-1900MHz and 1900-1980MHz, 2010-2025MHz, 2400-2483.5MHz The specification lacks any information how other IMT bands can be used or identified.

iii) Bandwidth and Scalability

*DECT reported that the “bandwidth can be scaled upto 108 MHz with 1024 FFT and 432 MHz per link with 1024 FFT”*.

**5GIF Comments**

It is noted that the value provided seems to have calculation error, the calculation is based on assumption of SCS=108kHz and 432 KHz using 1024 FFT points would lead to the maximum bandwidth of 110.592 MHz and 4.42 GHz respectively. Although, 5GIF could not find any specifications related SCS other than 27kHz.

#### *1.2.1.2 LINK BUDGET TEMPLATES*

*i) Macro mMTC*

**5GIF Comments:**

- a) The link budget is ambiguous because it reports same coverage for control & data for both Uplink and downlink
- b) The link budget is missing important parameters ( recommended in M.2411) - Tx & Rx antenna ports , UE speed=0



- c) Transmission bit rate value is same for both data & control channel
- d) Required SNR values for both control channel and data channel are same
- e) Link-budget for O2I is missing, which is needed to understand the technology as 80% UEs devices are assumed indoor and transmitter is outdoor.

### *SELF-EVALUATION REPORT*

The Self-evaluation report refers to some results based on the specification and study report ETSI - TS 103 514, which has simulation using channel models used for IEEE 802.11ax, these channel models are same as M2412.

#### **A. Connection Density**

The Self-evaluation report in 5D/1299 assumes a MESH based topology and relies on multi-hop communication to get the device from a MTC device to the network.

#### **5GIF Comments:**

- a) The linkbudget for mMTC though claims to have a coverage of data, control channel of 480m with 100% reliability, but in the self-evaluation it is stated that *DECT with star topology does not meet coverage requirement due to which multihop mesh technology is implemented in mMTC scenario*. There is inconsistency in understanding the technology's coverage.
- b) The details in the Self-evaluation for connection density is not very clear, and it appears to not follow the M.2412 evaluation methodology.
  - a. the principle understanding of "Minimum requirement" of any technical performance metric implies that the technology will be able to support lower than the minimum requirement.
  - b. Since the connection density evaluation of DECT very much depends on "relaying", if the number of MTC devices are very less like just few 10s in a network layout of ISD=500m, it is very likely to fail.
  - c. So even if the technology meets minimum devices of 1,000,000/sqkm, it is very likely it won't meet the requirements if there less than the minimum devices.
- c) The evaluation of relay-based simulation requires – Channel model between device to device, which are at the same height (1.5m), which is not supported in the current channel model in M.2412. The report has no details about it.
- d) Interference characteristics and modelling is also needed to understand the quality of multi-hop relaying to ensure the small packets are delivered to the final network within the given time with 1% PER probability.
- e) The uplink power class being 23dBm, seems the simulation is not evaluated with 23dBm UE power class and hence is not according to ITU-R evaluation methodology. If the self-evaluation had used 23dB, the UL coverage as reported in link-budget implies no relaying would be needed.
- f) The self-evaluation report also does not explain how the "relay propagation" from one MTC device is restricted to flow to adjacent cells.

We observe that there is lot of inconsistency and lack of information to evaluate the ability of this candidate technology to meet the MTC requirements.

#### **B. Reliability**

##### **5GIF Observation**

- a) The self evaluation assumes 80% indoor and 20% outdoor in their simulation, whereas the ITU-R M.2412 requires 80% outdoor and 20% indoor in Urban Macro-mMTC Evaluation configuration A & B.
- b) It is not clear what is transmit power assumed in the simulation, as the M.2412 recommends 49dBm for 20MHz , where as the simulation performed by DECT Forum is for 1.728MHz. The report refers to still use the same transmit power 49dBm.

- c) The following important parameters needed to evaluate the system are not mentioned in the self-evaluation report –
1. UE mobility model, UE speeds of interest
  2. Mechanical tilt, Electronic tilt
  3. TRxP boresight, Wrapping around method
  4. Polarization,
  5. Number of TXRU in a panel
  6. Number of panels
  7. Polarized antenna model
  8. Horizontal and vertical spacing between antenna elements

### 1.3 Candidate technology - IMT-2020/18

#### **Proponents: NuFront**

Observations based on the specification of EUHT RIT as per the submission in IMT-2020/18 is as follows:

#### **A) Channel Switching Information**

Channel Switching Information Frame (Section 6.3.4.14 of EUHT Specification) is specified as follows:

- Contains a CAP/STA starting channel number. This field is 8 bits (0-255).
- Table 21(Section 6.3.4.14) of Specification states that channel number 3 for 2.4 GHz is supported and no other band support is mentioned as per the specification.
- Channel Identifier field can support 256 channels as per the specification (Section 6.3.4.19)

Observation: Only 256 channels in the 2.4 GHz band can be utilized.(Point C of Section 4.2) which is inconsistent with Self-Evaluation Report of EUHT.

#### **B) Spatial Streams**

- EUHT specification defines a spatial stream as a data stream that is spatially transmitted in parallel. A spatial-time stream is an encoded stream after space-time coding of the spatial stream.(Section 2.8 and 2.9 in EUHT Specification)
  - EUHT provides support for upto four spatial streams and upto eight spatial-time stream. The MCS support is only for spatial streams upto four. (Section 8.2.8 and Annex B in EUHT Specification)
- For more information refer Section 4.2

Observation: Only maximum four layers possible which is inconsistent with the usage of eight layers in the Self-Evaluation Report of EUHT.

#### **C) Working Bandwidth Mode**

- EUHT Submission 5D/1300, provides a STA basic capability request frame which specifies the working bandwidth mode of the STA.A *working bandwidth mode* specifies a combination of “*working bandwidth*” called as (*working bandwidth-1, working bandwidth-2 and working bandwidth-3*) from which the STA can choose one mode. Based on this specification, the maximum available bandwidth for a transmission is in the mode number 4 “**100 : 25/50/100**”, i.e. 100 MHz.
- For more information refer Section 4.2

Observation: The maximum supported bandwidth in EUHT RIT is 100 MHz which contrasts with the mentioned support for 6400 MHz in the Self-Evaluation Report of EUHT.

**D) Spectrum Aggregation Mode (Referring to Specification submitted in WP5D#32, See Attachment in Annex-J.1)**

In the revised submission 5D/1300, included in WP5D#33, these text in the section of the specification was missing.

- As per the specification referred:  
*“In spectrum aggregation mode, the STA resides on working bandwidth 1. The CAP can independently schedule 20MHz subchannels to transmit in parallel. A 20MHz STA can only be scheduled on one subchannel in one frame for transmission; a working bandwidth 2 STA can schedule one or two sub-channels in one frame for transmission; an working bandwidth 3 STA can schedule one or 2 or 3 or 4 sub-channels in one frame for transmission.”*
- 4 sub-channels aggregated to obtain an effective usage bandwidth equal to “working bandwidth mode”.
- The information regarding SCS, system bandwidth available in spectrum aggregation mode (Table 69 in Section 8.11.2.1) is presented in Table 1-1
- As per the latest available specification, the information provided above is missing in Section 8.11.

*Table 1-1 Spectrum aggregation mode (Section 8.11 of EUHT specification)*

**Table 69 Spectrum aggregation mode**

System bandwidth	20MHz	40MHz	80MHz
Subcarrier interval in frequency domain	78.125 KHz	78.125 KHz	78.125 KHz
Baseband sampling clock	20MHz	40MHz	80MHz

Nufront (Beijing) Technology Group Co., Ltd.

135

**新岸线**  
NUFRONT

FFT sample points	256	512	1024
Cyclic Prefix sample points	32	64	128
Number of data subcarriers	224	448	896
Number of phase tracking pilot subcarriers	6	12	24
Number of virtual subcarriers	26	52	104
FFT time window	12.8μs	12.8μs	12.8μs
Cyclic Prefix	1.6μs	1.6μs	1.6μs
OFDM symbol period	14.4μs	14.4μs	14.4μs

Providing an **example** of the working bandwidth mode, sub-channel and spectrum aggregation usage below:

If the supported **working bandwidth mode** is reported to be four (bit-pattern :100) by the STA, the STA can choose one of the three working **bandwidth** from 25/50/100 MHz (refer Table 4A). If the STA chooses to use the **working bandwidth-3 (100MHz)**, the CAP will make use of all the four **sub-channel** each of bandwidth equal to that of **working bandwidth-1**(i.e. 25 MHz).

**5GIF Observation:**

- a) Multiple bandwidth support is obtained by using four sub-channels where the possible sub-channel bandwidths are 5,10,15,20,25 MHz (Table 4A).
- b) Spectrum Aggregation Mode cannot be used in *mmWave* mode due to lack of support in specification for SCS=390.625 needed for *mmWave* (see Table 4C & Table 4B).
- c) Maximum System Bandwidth in Spectrum Aggregation mode is 80 MHz (Table 4B).
- d) Maximum Bandwidth supported by STA is 100 MHz (Table 4A).
- e) There is also inconsistency regarding bandwidths mentioned as 200MHz, 400MHz but no specification to support by STA (UE)

## 1.4 Candidate technologies - IMT-2020/19

***Proponents: TSDSI***

Working Party 5D (WP 5D) has identified at WP 5D meeting #33, in its review of the Proponent TSDSI updated submission in Document [5D/1301](#), the submission in Document 5D/1301 meets the completeness of Step 3 (document [IMT-2020/28 \(Rev 1\)](#)). This candidate technology is based on the 3GPP NR technology in IMT-2020/14 and the NB-IoT technology in IMT-2020/13, with certain technical modifications.

The proponents declared to WP5D that their self-evaluation report is only based on 3GPP features and without those technical modifications. Furthermore, as noted in Doc. IMT-2020/28 (Rev 1) in Part I Attachment 2, WP5D offers no endorsement of this supplementary information in the context of IMT-2020 suitability.

## 2. Assessment of Candidate technology by 3GPP –RIT (IMT-2020/14) & SRIT (IMT-2020/13)

The 5GIF IEG is hosted by COAI and is primarily interested in the independent evaluation of candidate technologies originating from 3GPP. In the past technologies originating from 3GPP viz. WCDMA (IMT-2000) and LTE-A (IMT-A) had global adoption and proved central to services rendered by our operator members. They are also dependent on the ecosystem created by the globally harmonized standards developed in 3GPP. Thus, the primary objective of the 5GIF IEG was to get a first-hand understanding of the 5G standard from 3GPP.

In this chapter, we provide our detailed assessment of the candidate RIT and SRIT technologies from 3GPP. The RIT candidate IMT-2020/14 refers to the NR radio interface technology. This single technology is designed to address the eMBB, mMTC and uRLLC use cases. The SRIT candidate IMT-2020/13 employs LTE-Advanced Pro for eMBB, NB-IoT and eMTC for mMTC and NR for uRLLC use cases. An independent assessment is made on these candidate technologies to understand what they promise, and to also understand what else it can offer.

This assessment also allows us to make a recommendation on the RIT submitted by China and Korea, both based on 3GPP technologies. While the Korean RIT is based entirely on IMT-2020/14, the RIT from China deviates in its use of NB-IoT for mMTC, which is from IMT-2020/13. While 3GPP has referenced Rel-15 specs during Step-2 of the IMT-2020 process, it is further expected that the Rel-16 specs will become part of the IMT-2020 recommendation, at the end of this IMT-2020 exercise. The technical evaluation however is based on the final submission made to the WP5D#32 meeting in, Bouzios, Brazil, where the submissions of the candidate technology from 3GPP was declared to have cleared STEP 3 of the IMT-2020 process. With LTE-A based deployments already ubiquitous, and NR based deployments happening in a rapid phase, the technologies from 3GPP is yet again expected to offer global seamless operations.

### 2.1 Compliance Templates

This section provides templates for the responses that are needed to assess the compliance of a candidate RIT or SRIT with the minimum requirements of IMT-2020. This assessment is independently done based on the characteristic template and 3GPP specifications referred in the submission by the proponents in [IMT-2020/3](#) (submission includes RIT (IMT-2020/14) and SRIT(IMT-2020/13)).

The compliance templates are based on ITU-R M.2411:

- Compliance template for services;
- Compliance template for spectrum; and,
- Compliance template for technical performance

As per the ITU-R Report M.2411, Section 5.2.4, the summary based on our evaluation is as below:

#### 2.1.1 Services

*(M.2411 - Compliance template for services 5.2.4.1)*

M.2411 Section	Service capability requirements	5GIF comments
5.2.4.1.1	<p><b>Support for wide range of services</b></p> <p>Is the proposal able to support a range of services across different usage scenarios (eMBB, URLLC, and mMTC)?</p> <p>Specify which usage scenarios (eMBB, URLLC, and mMTC) the candidate RIT or candidate SRIT can support</p>	<p>[x] YES / <del>No</del></p> <p><i>The 3GPP NR (RIT) supports all the three usage scenarios (eMBB, URLLC and mMTC) through configurable slot types (DL/UL combinations), different bandwidth combinations and schemes to support large number devices for mMTC</i></p>

## 2.1.2 Spectrum

### (M.2411 - Compliance template for spectrum - 5.2.4.2)

<b>Spectrum capability requirements</b>																																																																																																																													
<b>5.2.4.2.1</b>	<p><b>Frequency bands identified for IMT</b></p> <p>Is the proposal able to utilize at least one frequency band identified for IMT in the ITU Radio Regulations?  <input checked="" type="checkbox"/> YES / <input type="checkbox"/> NO</p> <p>Specify in which band(s) the candidate RIT or candidate SRIT can be deployed.</p> <p><i>The proponent has identified support for the following bands in their submission.</i></p> <table border="1" style="width: 100%; border-collapse: collapse;"> <thead> <tr> <th style="text-align: center;">NR operating band</th> <th style="text-align: center;">Uplink (UL) operating band BS receive / UE transmit F<sub>UL_low</sub> – F<sub>UL_high</sub></th> <th style="text-align: center;">Downlink (DL) operating band BS transmit / UE receive F<sub>DL_low</sub> – F<sub>DL_high</sub></th> <th style="text-align: center;">Duplex Mode</th> </tr> </thead> <tbody> <tr><td style="text-align: center;">n1</td><td style="text-align: center;">1920 MHz – 1980 MHz</td><td style="text-align: center;">2110 MHz – 2170 MHz</td><td style="text-align: center;">FDD</td></tr> <tr><td style="text-align: center;">n2</td><td style="text-align: center;">1850 MHz – 1910 MHz</td><td style="text-align: center;">1930 MHz – 1990 MHz</td><td style="text-align: center;">FDD</td></tr> <tr><td style="text-align: center;">n3</td><td style="text-align: center;">1710 MHz – 1785 MHz</td><td style="text-align: center;">1805 MHz – 1880 MHz</td><td style="text-align: center;">FDD</td></tr> <tr><td style="text-align: center;">n5</td><td style="text-align: center;">824 MHz – 849 MHz</td><td style="text-align: center;">869 MHz – 894 MHz</td><td style="text-align: center;">FDD</td></tr> <tr><td style="text-align: center;">n7</td><td style="text-align: center;">2500 MHz – 2570 MHz</td><td style="text-align: center;">2620 MHz – 2690 MHz</td><td style="text-align: center;">FDD</td></tr> <tr><td style="text-align: center;">n8</td><td style="text-align: center;">880 MHz – 915 MHz</td><td style="text-align: center;">925 MHz – 960 MHz</td><td style="text-align: center;">FDD</td></tr> <tr><td style="text-align: center;">n12</td><td style="text-align: center;">699 MHz – 716 MHz</td><td style="text-align: center;">729 MHz – 746 MHz</td><td style="text-align: center;">FDD</td></tr> <tr><td style="text-align: center;">n20</td><td style="text-align: center;">832 MHz – 862 MHz</td><td style="text-align: center;">791 MHz – 821 MHz</td><td style="text-align: center;">FDD</td></tr> <tr><td style="text-align: center;">n25</td><td style="text-align: center;">1850 MHz – 1915 MHz</td><td style="text-align: center;">1930 MHz – 1995 MHz</td><td style="text-align: center;">FDD</td></tr> <tr><td style="text-align: center;">n28</td><td style="text-align: center;">703 MHz – 748 MHz</td><td style="text-align: center;">758 MHz – 803 MHz</td><td style="text-align: center;">FDD</td></tr> <tr><td style="text-align: center;">n34</td><td style="text-align: center;">2010 MHz – 2025 MHz</td><td style="text-align: center;">2010 MHz – 2025 MHz</td><td style="text-align: center;">TDD</td></tr> <tr><td style="text-align: center;">n38</td><td style="text-align: center;">2570 MHz – 2620 MHz</td><td style="text-align: center;">2570 MHz – 2620 MHz</td><td style="text-align: center;">TDD</td></tr> <tr><td style="text-align: center;">n39</td><td style="text-align: center;">1880 MHz – 1920 MHz</td><td style="text-align: center;">1880 MHz – 1920 MHz</td><td style="text-align: center;">TDD</td></tr> <tr><td style="text-align: center;">n40</td><td style="text-align: center;">2300 MHz – 2400 MHz</td><td style="text-align: center;">2300 MHz – 2400 MHz</td><td style="text-align: center;">TDD</td></tr> <tr><td style="text-align: center;">n41</td><td style="text-align: center;">2496 MHz – 2690 MHz</td><td style="text-align: center;">2496 MHz – 2690 MHz</td><td style="text-align: center;">TDD</td></tr> <tr><td style="text-align: center;">n51</td><td style="text-align: center;">1427 MHz – 1432 MHz</td><td style="text-align: center;">1427 MHz – 1432 MHz</td><td style="text-align: center;">TDD</td></tr> <tr><td style="text-align: center;">n66</td><td style="text-align: center;">1710 MHz – 1780 MHz</td><td style="text-align: center;">2110 MHz – 2200 MHz</td><td style="text-align: center;">FDD</td></tr> <tr><td style="text-align: center;">n70</td><td style="text-align: center;">1695 MHz – 1710 MHz</td><td style="text-align: center;">1995 MHz – 2020 MHz</td><td style="text-align: center;">FDD</td></tr> <tr><td style="text-align: center;">n71</td><td style="text-align: center;">663 MHz – 698 MHz</td><td style="text-align: center;">617 MHz – 652 MHz</td><td style="text-align: center;">FDD</td></tr> <tr><td style="text-align: center;">n75</td><td style="text-align: center;">N/A</td><td style="text-align: center;">1432 MHz – 1517 MHz</td><td style="text-align: center;">SDL</td></tr> <tr><td style="text-align: center;">n76</td><td style="text-align: center;">N/A</td><td style="text-align: center;">1427 MHz – 1432 MHz</td><td style="text-align: center;">SDL</td></tr> <tr><td style="text-align: center;">n77</td><td style="text-align: center;">3300 MHz – 4200 MHz</td><td style="text-align: center;">3300 MHz – 4200 MHz</td><td style="text-align: center;">TDD</td></tr> <tr><td style="text-align: center;">n78</td><td style="text-align: center;">3300 MHz – 3800 MHz</td><td style="text-align: center;">3300 MHz – 3800 MHz</td><td style="text-align: center;">TDD</td></tr> <tr><td style="text-align: center;">n79</td><td style="text-align: center;">4400 MHz – 5000 MHz</td><td style="text-align: center;">4400 MHz – 5000 MHz</td><td style="text-align: center;">TDD</td></tr> <tr><td style="text-align: center;">n80</td><td style="text-align: center;">1710 MHz – 1785 MHz</td><td style="text-align: center;">N/A</td><td style="text-align: center;">SUL</td></tr> <tr><td style="text-align: center;">n81</td><td style="text-align: center;">880 MHz – 915 MHz</td><td style="text-align: center;">N/A</td><td style="text-align: center;">SUL</td></tr> <tr><td style="text-align: center;">n82</td><td style="text-align: center;">832 MHz – 862 MHz</td><td style="text-align: center;">N/A</td><td style="text-align: center;">SUL</td></tr> <tr><td style="text-align: center;">n83</td><td style="text-align: center;">703 MHz – 748 MHz</td><td style="text-align: center;">N/A</td><td style="text-align: center;">SUL</td></tr> <tr><td style="text-align: center;">n84</td><td style="text-align: center;">1920 MHz – 1980 MHz</td><td style="text-align: center;">N/A</td><td style="text-align: center;">SUL</td></tr> <tr><td style="text-align: center;">n86</td><td style="text-align: center;">1710 MHz – 1780 MHz</td><td style="text-align: center;">N/A</td><td style="text-align: center;">SUL</td></tr> </tbody> </table>	NR operating band	Uplink (UL) operating band BS receive / UE transmit F <sub>UL_low</sub> – F <sub>UL_high</sub>	Downlink (DL) operating band BS transmit / UE receive F <sub>DL_low</sub> – F <sub>DL_high</sub>	Duplex Mode	n1	1920 MHz – 1980 MHz	2110 MHz – 2170 MHz	FDD	n2	1850 MHz – 1910 MHz	1930 MHz – 1990 MHz	FDD	n3	1710 MHz – 1785 MHz	1805 MHz – 1880 MHz	FDD	n5	824 MHz – 849 MHz	869 MHz – 894 MHz	FDD	n7	2500 MHz – 2570 MHz	2620 MHz – 2690 MHz	FDD	n8	880 MHz – 915 MHz	925 MHz – 960 MHz	FDD	n12	699 MHz – 716 MHz	729 MHz – 746 MHz	FDD	n20	832 MHz – 862 MHz	791 MHz – 821 MHz	FDD	n25	1850 MHz – 1915 MHz	1930 MHz – 1995 MHz	FDD	n28	703 MHz – 748 MHz	758 MHz – 803 MHz	FDD	n34	2010 MHz – 2025 MHz	2010 MHz – 2025 MHz	TDD	n38	2570 MHz – 2620 MHz	2570 MHz – 2620 MHz	TDD	n39	1880 MHz – 1920 MHz	1880 MHz – 1920 MHz	TDD	n40	2300 MHz – 2400 MHz	2300 MHz – 2400 MHz	TDD	n41	2496 MHz – 2690 MHz	2496 MHz – 2690 MHz	TDD	n51	1427 MHz – 1432 MHz	1427 MHz – 1432 MHz	TDD	n66	1710 MHz – 1780 MHz	2110 MHz – 2200 MHz	FDD	n70	1695 MHz – 1710 MHz	1995 MHz – 2020 MHz	FDD	n71	663 MHz – 698 MHz	617 MHz – 652 MHz	FDD	n75	N/A	1432 MHz – 1517 MHz	SDL	n76	N/A	1427 MHz – 1432 MHz	SDL	n77	3300 MHz – 4200 MHz	3300 MHz – 4200 MHz	TDD	n78	3300 MHz – 3800 MHz	3300 MHz – 3800 MHz	TDD	n79	4400 MHz – 5000 MHz	4400 MHz – 5000 MHz	TDD	n80	1710 MHz – 1785 MHz	N/A	SUL	n81	880 MHz – 915 MHz	N/A	SUL	n82	832 MHz – 862 MHz	N/A	SUL	n83	703 MHz – 748 MHz	N/A	SUL	n84	1920 MHz – 1980 MHz	N/A	SUL	n86	1710 MHz – 1780 MHz	N/A	SUL
NR operating band	Uplink (UL) operating band BS receive / UE transmit F <sub>UL_low</sub> – F <sub>UL_high</sub>	Downlink (DL) operating band BS transmit / UE receive F <sub>DL_low</sub> – F <sub>DL_high</sub>	Duplex Mode																																																																																																																										
n1	1920 MHz – 1980 MHz	2110 MHz – 2170 MHz	FDD																																																																																																																										
n2	1850 MHz – 1910 MHz	1930 MHz – 1990 MHz	FDD																																																																																																																										
n3	1710 MHz – 1785 MHz	1805 MHz – 1880 MHz	FDD																																																																																																																										
n5	824 MHz – 849 MHz	869 MHz – 894 MHz	FDD																																																																																																																										
n7	2500 MHz – 2570 MHz	2620 MHz – 2690 MHz	FDD																																																																																																																										
n8	880 MHz – 915 MHz	925 MHz – 960 MHz	FDD																																																																																																																										
n12	699 MHz – 716 MHz	729 MHz – 746 MHz	FDD																																																																																																																										
n20	832 MHz – 862 MHz	791 MHz – 821 MHz	FDD																																																																																																																										
n25	1850 MHz – 1915 MHz	1930 MHz – 1995 MHz	FDD																																																																																																																										
n28	703 MHz – 748 MHz	758 MHz – 803 MHz	FDD																																																																																																																										
n34	2010 MHz – 2025 MHz	2010 MHz – 2025 MHz	TDD																																																																																																																										
n38	2570 MHz – 2620 MHz	2570 MHz – 2620 MHz	TDD																																																																																																																										
n39	1880 MHz – 1920 MHz	1880 MHz – 1920 MHz	TDD																																																																																																																										
n40	2300 MHz – 2400 MHz	2300 MHz – 2400 MHz	TDD																																																																																																																										
n41	2496 MHz – 2690 MHz	2496 MHz – 2690 MHz	TDD																																																																																																																										
n51	1427 MHz – 1432 MHz	1427 MHz – 1432 MHz	TDD																																																																																																																										
n66	1710 MHz – 1780 MHz	2110 MHz – 2200 MHz	FDD																																																																																																																										
n70	1695 MHz – 1710 MHz	1995 MHz – 2020 MHz	FDD																																																																																																																										
n71	663 MHz – 698 MHz	617 MHz – 652 MHz	FDD																																																																																																																										
n75	N/A	1432 MHz – 1517 MHz	SDL																																																																																																																										
n76	N/A	1427 MHz – 1432 MHz	SDL																																																																																																																										
n77	3300 MHz – 4200 MHz	3300 MHz – 4200 MHz	TDD																																																																																																																										
n78	3300 MHz – 3800 MHz	3300 MHz – 3800 MHz	TDD																																																																																																																										
n79	4400 MHz – 5000 MHz	4400 MHz – 5000 MHz	TDD																																																																																																																										
n80	1710 MHz – 1785 MHz	N/A	SUL																																																																																																																										
n81	880 MHz – 915 MHz	N/A	SUL																																																																																																																										
n82	832 MHz – 862 MHz	N/A	SUL																																																																																																																										
n83	703 MHz – 748 MHz	N/A	SUL																																																																																																																										
n84	1920 MHz – 1980 MHz	N/A	SUL																																																																																																																										
n86	1710 MHz – 1780 MHz	N/A	SUL																																																																																																																										
<b>5.2.4.2.2</b>	<p><b>Higher Frequency range/band(s)</b></p> <p>Is the proposal able to utilize the higher frequency range/band(s) above 24.25 GHz?: <input checked="" type="checkbox"/> YES / <input type="checkbox"/> NO</p> <p>Specify in which band(s) the candidate RIT or candidate SRIT can be deployed.</p> <p>NOTE 1 – In the case of the candidate SRIT, at least one of the component RITs need to fulfil this requirement.</p>																																																																																																																												

The proponent has identified support for the following bands in their submission.

NR operating band	Uplink (UL) and Downlink (DL) operating band BS transmit/receive UE transmit/receive F <sub>UL,low</sub> – F <sub>UL,high</sub> F <sub>DL,low</sub> – F <sub>DL,high</sub>	Duplex Mode
n257	26500 MHz – 29500 MHz	TDD
n258	24250 MHz – 27500 MHz	TDD
n260	37000 MHz – 40000 MHz	TDD
n261	27500 MHz – 28350 MHz	TDD

**5GIF Comments**

- This candidate technology has support for bands identified for IMT-2020 based on the 3GPP TS 38.104 specifications.,
- Text highlighted in blue are possible candidate bands in India, and the 5GIF Evaluation will prioritize our studies on them

### 2.1.3 Technical Performance

(M.2411 - Compliance template for technical performance from 5.2.4.3)

Minimum technical performance requirements item (5.2.4.3.x), units, and Report ITU-R M.2410-0 section reference <sup>(1)</sup>	Category			Required value	Value <sup>(2)</sup>	Requirement met?	5GIF Comments
	Usage scenario	Test environment	Downlink or uplink				
5.2.4.3.1 Peak data rate (Gbit/s) (4.1)	eMBB	Not applicable	Downlink	20	21.74 – 34.98	✓ Yes	Refer Section 2.2 (Analysis Aspects) <b>Range</b> : By using multiple component Carriers for aggregate BW of 500MHz(400+100)-800MHz in FR2.
			Uplink	10	11.81 – 19.0	✓ Yes	
5.2.4.3.2 Peak spectral efficiency (bit/s/Hz) (4.2)	eMBB	Not applicable	Downlink	30	31.7 – 47.9	✓ Yes	Refer Section 2.2 (Analysis Aspects) For DDSU frame format for various subcarrier spacing, bandwidth(5 MHz to 400 Mhz) using FR1 and FR2
			Uplink	15	18.2 – 22.8	✓ Yes	
5.2.4.3.3 User experienced data rate (Mbit/s) (4.3)	eMBB	Dense Urban – eMBB	Downlink	100	107.8-187.2	✓ Yes	Refer Section 2.2 (Analysis Aspects) <b>Range</b> : corresponds to <u>minimum</u> aggregated bandwidth of 3CC~180MHz for Config A(4GHz) and using 3CC (300MHz) in 4GHz band Note upto 16CC is supported in the technology for achieving higher user experienced data rate
			Uplink	50	74.98 – 128.7	✓ Yes	



<b>5.2.4.3.4</b> 5 <sup>th</sup> percentile user spectral efficiency (bit/s/Hz) (4.4)	eMBB	Indoor Hotspot – eMBB	Downlink	0.30	0.37 (FR1) 0.302 (FR2)	✓ Yes	<i>Refer Section 2.2 (Simulation Aspects)</i> <i>Config A (FR1 : 4GHz) with 36TRxP</i> <i>Config B (FR2 : 30GHz) with 36TRxP</i>
			Uplink	0.21	0.42 (FR1) 0.425 (FR2)	✓ Yes	
	eMBB	Dense Urban – eMBB	Downlink	0.225	0.375	✓ Yes	<i>Refer Section 2.2 (Simulation Aspects)</i> <i>Config A : 4GHz, TDD</i>
			Uplink	0.15	0.3	✓ Yes	
	eMBB	Rural – eMBB (Required to meet for Config A or B)	Downlink	0.12	-NA-	✓ Yes	<i>Refer Section 2.2 (Simulation Aspects)</i> <b>Config C</b> :See 4.4, M.2410, requirement not applicable, but see Section 2.2.3 for the evaluated results. <b>Config A</b> : ( 700MHz, ISD=1732m,FDD) <b>Config B</b> : (4GHz, ISD=1732m, TDD)  <i>Note : See Section 2.2.3 for supplementary evaluation for rural deployment</i>
					0.138 (Config A) 0.374 (ConfigB)		
Uplink			0.045	-NA-	✓ Yes		
				0.134 (Config A) 0.123 (Config B)			
<b>5.2.4.3.5</b> Average spectral efficiency (bit/s/Hz/ TRxP) (4.5)	eMBB	Indoor Hotspot – eMBB	Downlink	9	12.725 (FR1) 11.384 (FR2)	✓ Yes	<i>Refer Section 2.2 (Simulation Aspects)</i> <i>Config A (FR1 : 4GHz) with 36TRxP</i> <i>Config B (FR2 : 30GHz) with 36TRxP</i>
			Uplink	6.75	7.551 (FR1) 7.392 (FR2)	✓ Yes	
	eMBB	Dense Urban – eMBB	Downlink	7.8	12.8	✓ Yes	<i>Refer Section 2.2 (Simulation Aspects)</i> <i>Config A : 4GHz, TDD</i>
			Uplink	5.4	6.662	✓ Yes	
	eMBB	Rural – eMBB	Downlink	3.3	7.597(Config C)	✓ Yes	<i>Refer Section 2.2 (Simulation Aspects)</i> <ul style="list-style-type: none"> <li>Config C (mandatory, LMLC) : 700MHz, ISD=6000m,FDD)</li> <li>Config A( 700MHz, ISD=1732m,FDD)</li> <li>Config B( 4GHz, ISD=1732m, TDD)</li> </ul>
					6.594 (Config A) 15.061 (ConfigB)	✓ Yes	
Uplink			1.6	4.038 (Config C)	✓ Yes		

					4.17 (Config A) 3.457 (Config B)	✓ Yes	
<b>5.2.4.3.6</b> Area traffic capacity (Mbit/s/m <sup>2</sup> ) (4.6)	eMBB	Indoor-Hotspot – eMBB	Downlink	10	10.51-18.9	✓ Yes	<i>Refer Section 2.2 (Analysis Aspects)</i> Config A (4GHz,TDD) : 12TRxP & 36TRxP. Aggregated bandwidth of 300MHz with 3CC
<b>5.2.4.3.7</b> User plane latency (ms) (4.7.1)	eMBB	Not applicable	Uplink and Downlink	4	0.86 – 3.9	✓ Yes	<i>Refer Section 2.2 (Analysis Aspects)</i> Using various TTI duration (mini-slots), flexible UL & DL format and SCS allows to achieve UP latency below 4ms in both FDD & TDD
	URLLC	Not applicable	Uplink and Downlink	1	0.31 – 0.96	✓ Yes	<i>Refer Section 2.2 (Analysis Aspects)</i> Using various TTI duration (mini-slots), flexible UL & DL format and SCS allows to achieve UP latency below 1ms in both FDD & TDD
<b>5.2.4.3.8</b> Control plane latency (ms) (4.7.2) 10ms is encouraged	eMBB	Not applicable	Not applicable	20	8.5 – 20	✓ Yes	<i>Refer Section 2.2 (Analysis Aspects)</i> Using various TTI duration (mini-slots), flexible UL & DL format and SCS allows to achieve CP latency below 20ms in both FDD & TDD
	URLLC	Not applicable	Not applicable	20	6.5 – 10	✓ Yes	
<b>5.2.4.3.9</b> Connection density (devices/km <sup>2</sup> ) (4.8)	mMTC	Urban Macro – mMTC	Uplink	1,000,000	<b>NR</b> <u>IMT-2020/14</u> 1,465,000 – 35,021,000	✓ Yes	<i>Refer Section 2.2 (Simulation Aspects)</i> <ul style="list-style-type: none"> <li>NR ((IMT-2020/14) Corresponds to cells ISD, 1732 m and 500 m, respectively.</li> <li>NB-IoT (IMT-2020/13) Corresponds to cells ISD, 1732 m and 500 m, respectively.</li> </ul> <i>Note that the candidate submission IMT-2020/16 from Korea used NR as the mMTC candidate, and the candidate submission from China IMT-2020/15 uses NB-IoT. Both these candidates satisfy their individual connection density requirement due to 3GPP satisfying those requirements.</i>
					NB-IoT <u>IMT2020/13</u> 2,567,000-43,846,000	✓ Yes	

<b>5.2.4.3.10</b> Energy efficiency (4.9)	eMBB	Not applicable	Not applicable	Capability to support a high sleep ratio and long sleep duration	Yes	✓ Yes	<i>Refer Section 2.2 (Inspection Aspects)</i> For all bandwidth configurations 3GPP NR supports sleep ratio of more than 99% at symbol and slot level
<b>5.2.4.3.11</b> Reliability (4.10)	URLLC	Urban Macro –URLLC	Uplink or Downlink	1-10 <sup>-5</sup> success probability of transmitting a layer 2 PDU (protocol data unit) of size 32 bytes within 1 ms in channel quality of coverage edge	Yes	✓ Yes	<i>Refer Section 2.2 (Simulation Aspects)</i> 3GPP NR supports multiple code rates for which reliable packet transmission targeting 10-5 BLER is possible by allocating different number of PRB's for the same user
<b>5.2.4.3.12</b> Mobility classes (4.11)	eMBB	Indoor Hotspot – eMBB	Uplink	Stationary, Pedestrian	Yes	✓ Yes	<i>Refer Section 2.2 (Simulation Aspects)</i> NLOS (LOS) values <ul style="list-style-type: none"> <li>Indoor Hotspot – Config A (4GHz, TDD) :</li> <li>Dense Urban – Config A(4GHz, TDD, NLOS &amp; LOS)</li> <li>Rural (120kmph, 500kmph) Config A (700MHz, FDD)</li> </ul>
	eMBB	Dense Urban – eMBB	Uplink	Stationary, Pedestrian, Vehicular (up to 30 km/h)	Yes	✓ Yes	
	eMBB	Rural – eMBB	Uplink	Pedestrian, Vehicular, High speed vehicular	Yes	✓ Yes	
<b>5.2.4.3.13</b> Mobility Traffic channel link data rates (bit/s/Hz) (4.11)	eMBB	Indoor Hotspot – eMBB	Uplink	1.5 (10 km/h)	1.59 (1.94)	✓ Yes	
	eMBB	Dense Urban – eMBB	Uplink	1.12 (30 km/h)	1.82 (2.17)	✓ Yes	

	eMBB	Rural eMBB	–	Uplink	0.8 (120 km/h)	2.32 (2.90)	✓ Yes	
					0.45 (500 km/h)	2.07(2.64)	✓ Yes	
<b>5.2.4.3.14</b> Mobility interruption time (ms) (4.12)	eMBB and URLLC	Not applicable		Not applicable	0	0	✓ Yes	<i>Refer Section 2.2 (Analysis Aspects)</i> 3GPP NR supports beam mobility and CA mobility to allow make-before-break resulting into 0 ms mobility interruption time. Applicable for both eMBB and uRLLC
<b>5.2.4.3.15</b> Bandwidth and Scalability (4.13)	Not applicable	Not applicable	Not applicable	At least 100 MHz	100 MHz and more		✓ Yes	<i>Refer Section 2.2 (Inspection Aspects)</i> 3GPP NR supports different component carrier bandwidth from 5 MHz to 100 MHz (in FR1), and allows up to 16 component carrier aggregation
				Up to 1 GHz	1 GHz and more		✓ Yes	<i>Refer Section 2.2 (Inspection Aspects)</i> 3GPP NR supports different component carrier bandwidth from 50 MHz to 400 MHz (in FR2), and allows up to 16 component carrier aggregation
				Support of multiple different bandwidth values <sup>(4)</sup>	Supported		✓ Yes	

(1) As defined in Report ITU-R M.2410-0.

(2) According to the evaluation methodology specified in Report ITU-R M.2412-0.

(3) Proponents should report their selected evaluation methodology of the Connection density, the channel model variant used, and evaluation configuration(s) with their exact values (e.g. antenna element number, bandwidth, etc.) per test environment, and could provide other relevant information as well. For details, refer to Report ITU-R M.2412-0, in particular, § 7.1.3 for the evaluation methodologies, § 8.4 for the evaluation configurations per each test environment, and Annex 1 on the channel model variants.

(4) Refer to § 7.3.1 of Report ITU-R M.2412-0.

## 2.1.4 Link Budget Templates

*(M.2411 - Description template – link budget template, 5.2.3.3)*

Note: the 5GIF evaluation team had identified some minor discrepancies in the link budget tables, when compared with the ones submitted by the proponents. The anomalies correspond to the formulae used to (reverse) map the distance. These were then communicated to the proponents at WP5D#33.

The link budget tables for the candidate technology in IMT-2020/14 for the different channel models being considered is embedded below.



LB for 3GPP 5G NR  
RIT ChA - 5GIF.xlsx

Channel model B:



LB for 3GPP 5G NR  
RIT ChB - 5GIF.xlsx

### **5GIF Observation**

Regarding the pathloss models in M.2412, the 5GIF observes that the formula for LMLC gives a 12 dB relaxation in NLOS, which is understood to have been updated based on the field measurement contribution in 5D/111. We are not able to corroborate this model with the vast literature available on channel models. We are therefore of the view that WP5D needs to have further studies on the validity of this model, before its application to other studies within ITU and elsewhere.

Furthermore, the 12 dB relaxation in pathloss with the channel model is technology agnostic, and is therefore applicable for any of the candidates, but limited to the specific environment in which the measurements were made.

## 2.2 Detailed Technical Evaluation

This section provides the details of the evaluation and 5GIF findings on the 3GPP RIT candidate IMT-2020/14 and the NB-IoT component of the 3GPP SRIT candidate IMT-2020/13.

### 2.2.1 Analysis Aspects

In this section, analytical based approach is used to determine the technical performance of the technology. The analysis uses closed form expression based on the inputs and description of technical features in the description template as well as the relevant specifications needed to support those technical features.

Technical Performance calculated in this section are:

- Peak Spectral Efficiency
- Peak Data Rate
- User Experienced Data Rate
- Area Traffic Capacity
- Control & User Plane Latency
- Mobility Interruption Time

*Table 2-1 Antenna Configurations for peak spectral efficiency & peak data rate (from M.2412)*

Parameters	Values
Number of BS antenna elements	700 MHz: Up to 64 Tx/Rx 4 GHz / 30 GHz: Up to 256 Tx /Rx 70 GHz: Up to 1 024 Tx/Rx
Number of UE antenna elements	700 MHz / 4 GHz: Up to 8 Tx /Rx 30 GHz: Up to 32 Tx /Rx 70 GHz: Up to 64 Tx /Rx

#### 2.2.1.1 PEAK SPECTRAL EFFICIENCY

##### Requirements

Performance Measure	Minimum Requirements
Peak Spectral Efficiency	DL: 30 bps/Hz UL: 15 bps/Hz

##### Evaluation Methodology

*(Section 7.2.1 of M.2412)*

The proponent should report the assumed frequency band(s) of operation and channel bandwidth, for which the peak spectral efficiency value is achievable.

For TDD, the channel bandwidth information should include the **effective bandwidth**, which is the operating bandwidth normalized appropriately considering the **uplink/downlink ratio**.

- The antenna configuration to be assumed for calculation of peak spectral efficiency as well as peak data rate is defined in the M.2412 report (reproduced below).
- L1 and L2 overhead (OH) should be accounted for in time and frequency, in the same way as assumed for the “Average spectral efficiency”

- Proponents should demonstrate that the peak spectral efficiency requirements can be met for, at least, one of the carrier frequencies assumed in the test environments under the eMBB usage scenario.

As recommended in the M.2412, we have evaluated the Peak-spectral efficiency for the following Test environments - Rural, Urban Macro and Indoor Hotspot for the two frequency ranges FR1 - f<6GHz and FR2 : >24.25 GHz

## Results

The 3GPP candidate technology supports various channel bandwidth as well as aggregation of multiple carrier within as well as across bands. For a given channel bandwidth and the sub-carrier spacing (SCS) used the total number of subcarrier available in the carrier (OFDM symbol) varies. A group of 12 subcarriers is called PRB (Physical Resource Block) and spans across 7 or 14 OFDM symbols in time within a transmission slot (TTI – Transmit Time Interval).

The 3GPP RAN4 specifies the maximum number of PRB (Physical Resource Blocks) available for a given SCS (Subcarrier spacing) and channel bandwidth. As shown below for the frequency ranges above and below 6GHz<sup>3</sup>.

Table 2-2 Max number of PRBs for FR1 and FR2

SCS (kHz)	Channel Bandwidth (MHz)											
	5	10	15	20	25	40	50	60	80	100	200	400
<i>For FR1 frequency range</i>												
15	25	52	79	106	133	216	270					
30	11	24	38	51	65	106	133	162	217	273		
60		11	18	24	31	51	65	79	107	135		
<i>For FR2 frequency ranges only (mmwave)</i>												
60							66			132	264	
120							32			66	132	264

Each PRB can have 12 subcarriers and will span a bandwidth of 12\*SCS. For example in Table 2-2, row 2 has 273 PRBs. Each resource block has 12 carriers and each carrier, in turn, is 30 kHz, yielding a carrier bandwidth of 273\*12\*30 = 98.28 MHz. In the same table, row 3 yields a carrier bandwidth of 135\*12\*60 = 97.20 MHz.

In addition, NR can aggregate upto 16 such component carriers which means that other configurations could also potentially provide the requisite ITU bandwidth. From the definition and discussion in 3GPP<sup>4</sup> we can derive the generic formula for peak spectral efficiency for FDD and TDD for a specific component carrier (say *j*-th CC) as below.

$$SE_{p_j} = \frac{v_{Layers}^{(j)} \cdot Q_m^{(j)} \cdot f^{(j)} \cdot R_{max} \cdot \frac{N_{PRB}^{BW(j),\mu} \cdot 12}{T_s^\mu} \cdot (1 - OH^{(j)})}{BW^{(j)}} \quad (1)$$

Wherein

- $R_{max} = 948/1024$
- For the *j*-th CC,
  - $v_{Layers}^{(j)}$  is the maximum number of layers
  - $Q_m^{(j)}$  is the maximum modulation order
  - $f^{(j)}$  is the scaling factor
    - The scaling factor can at least take the values 1 and 0.75.
    - $f^{(j)}$  is signalled per band and per band per band combination as per UE capability signalling
  - $\mu$  is the numerology (as defined in TS38.211)

<sup>3</sup> [R4-1806932](#), “TS 38.104 Combined updates (NSA) from RAN4 #86bis and RAN4 #87,” Ericsson

<sup>4</sup> R1-1721732, “Reply to LS on NR UE Category”, RAN1, November 2017

- $T_s^\mu$  is the average OFDM symbol duration in a subframe for numerology  $\mu$ , i.e.  $T_s^\mu = \frac{10^{-3}}{14 \cdot 2^\mu}$ . Note that normal cyclic prefix is assumed.
- $N_{PRB}^{BW(j),\mu}$  is the maximum PRB allocation in bandwidth  $BW^{(j)}$  with numerology  $\mu$ , as given in TR 38.817-01 section 4.5.1, where  $BW^{(j)}$  is the UE supported maximum bandwidth in the given band or band combination.
- $OH^{(j)}$  is the overhead calculated as the average ratio of the number of REs occupied by L1/L2 control, Synchronization Signal, PBCH and reference signals etc. with respect to the total number of REs in effective bandwidth time product  $\alpha^{(j)} \cdot BW^{(j)} \cdot (14 \times T_s^\mu)$ .
  - $\alpha^{(j)}$  is the normalized scalar considering the downlink/uplink ratio; for FDD  $\alpha^{(j)}=1$  for DL and UL; and for TDD and other duplexing  $\alpha^{(j)}$  for DL and UL is calculated based on the frame structure.
  - For guard period (GP), 50% of GP symbols are considered as downlink overhead, and 50% of GP symbols are considered as uplink overhead.

One of the important factor in the above expression is the OH (overhead) factor due to SSB (Synchronization Signal block), TRS (Tracking Reference Signal), PDCCH (Physical downlink Control channel – CCE in every slot), DM-RS (demodulation reference signal), PT-RS (phase-tracking reference signal) and CSI-RS (channel-state information reference signal) that have to be considered. Given the maximum number of Tx/Rx elements in ITU-R configurations, the maximum number of TXRU allowed is upto 8 layers.

### Downlink

For frequencies in FR1, for e.g. the 3.5GHz band is considered for early IMT2020 deployments, this band is a TDD band. In FR2, 26GHz, 28GHz and 39GHz bands are supported in 3GPP NR specifications. 3GPP NR candidate supports various TDD slot patterns. Table below shows parameters for a DL centric configuration **DDDSU** (i.e. Five slots – 3 slots with all downlink only symbols, Special Slot and one slot with all uplink-only symbols). The Special Slot (S) – has 11 DL symbols, 1 GP (Guard), 2 UL symbols.

Table 2-3 Assumptions for TDD DL peak spectral efficiency (DDDSU)

Parameters	Values	Remarks
$v_{Layers}^{(j)}$	FR1: 8 FR2: 6	NR supports up to 8 layers for a single user for DL in FR1 and 6 layers in FR2 when PTRS is transmitted.
$\alpha_{DL}^{(j)}$	0.7643	corresponds to DL:UL=4:1, where 3 DL slots, <ul style="list-style-type: none"> <li>• 1 UL slot is configured in every 5 slots;</li> <li>• S slot includes 11 DL symbols, 1 symbol for GP, and 2 UL symbol</li> </ul>
$Q_m^{(j)}$	8	supports up to 256QAM for DL (TS 38.306 and TS 38.331)
$f^{(j)}$	1	The value of 1 is chosen as scaling factor for DL peak spectral efficiency evaluation.
$R_{max}$	948/1024 = 0.9258	NR supports highest coding rate as $R_{max}=948/1024$ .
$\mu$	0, 1, 2, 3	SCS $\Delta f = 2^\mu \cdot 15$ [kHz]
$N_{PRB}^{BW(j),\mu}$	For FR1: <ul style="list-style-type: none"> <li>• 270 for 50MHz with 15kHz SCS</li> <li>• 273 for 100MHz with 30kHz SCS</li> <li>• 135 for 100MHz with 60kHz SCS</li> </ul>	See Section 5.3.2 of TS 38.104 v0.5.0 (See
$T_s^\mu$	$T_s^\mu = \frac{10^{-3}}{14 \cdot 2^\mu}$	SCS $\Delta f = 2^\mu \cdot 15$ [kHz]
$OH^{(j)}$	For FR1:	50% of GP symbols are considered as downlink overhead.



	<ul style="list-style-type: none"> <li>• 0.121 for 50MHz with 15kHz SCS</li> <li>• 0.118 for 100MHz with 30kHz SCS</li> <li>• 0.124 for 100MHz with 60kHz SCS</li> </ul> For FR2: <ul style="list-style-type: none"> <li>• 0.115 for 200MHz with 60kHz SCS</li> <li>• 0.112 for 400MHz with 120kHz SCS</li> </ul>	For FR1: <ul style="list-style-type: none"> <li>• CORESET of 24 PRBs (4 CCE) in every slot               <ul style="list-style-type: none"> <li>- 12 RE/PRB/slot</li> </ul> </li> <li>• TRS burst of 2 slots with periodicity of 20ms and occupies 52 PRBs               <ul style="list-style-type: none"> <li>- 12 RE/PRB/20ms</li> </ul> </li> <li>• DMRS: 16 RE/PRB/slot in every slot and PRB</li> <li>• CSI-RS: 8 CSI-RS ports with 8 RE/PRB/slot with periodicity of 20ms in every PRB</li> <li>• 1 SS/PBCH blocks per 20ms; one SS/PBCH block occupies 960REs = 4 OFDM symbols × 20 PRB × 12 REs/PRB</li> </ul> NOTE1: if the channel bandwidth is less than the bandwidth of SS/PBCH block, then SS/PBCH block is not transmitted and the overhead of SS/PBCH block is zero. NOTE2: If the channel bandwidth is less than TRS bandwidth, the TRS bandwidth is assumed to be equal to the channel bandwidth. For FR2: <ul style="list-style-type: none"> <li>• CORESET of 24 PPRBs (4 CCE) in every slot               <ul style="list-style-type: none"> <li>- 12 RE/PRB/slot</li> </ul> </li> <li>• TRS burst of 2 slots with periodicity of 10ms and occupies 52 PRBs               <ul style="list-style-type: none"> <li>- 12 RE/PRB/10ms</li> </ul> </li> <li>• DMRS: 12 RE/PRB/slot in every slot and PRB</li> <li>• PTRS: 1 port, frequency density is 4 PRB and time domain density is 1 symbol</li> <li>• CSI-RS: 8 CSI-RS ports with 8 RE/PRB/slot with periodicity of 10ms in every PRB</li> <li>• CSI-RS for BM: 1 CSI-RS port with 2 RE/PRB/slot with periodicity of 10ms in every PRB</li> <li>• 8 SS/PBCH blocks per 20ms; one SS/PBCH block occupies 960REs = 4 OFDM symbols × 20 PRB × 12 REs/PRB</li> </ul>
$BW^{(j)}$	5,10,15,20...100, 200, 400 (FR1 and FR2, SCS)	See Section 5.3.2 of TS38.104
$\mu$	0, 1, 2, 3	SCS $\Delta f = 2^\mu \cdot 15$ [kHz]

The DL peak spectral efficiency for NR TDD for different bandwidth and SCS parameters is shown in Table 2.1.1-2. The results are according to Eq. (1) and the detailed parameters as listed above. In this evaluation, the DL dominant frame structure “DDDSU” (DL:UL=4:1) is selected.

Table 2-4 NR TDD DL peak spectral efficiency (bit/s/Hz) (Frame structure: DDSU, DL:UL=4:1)

SC(kHz)		Channel Bandwidth (MHz)														Req.
		5	10	15	20	25	30	40	50	60	80	90	100	200	400	
FR1	15	39.6	43.6	44.9	45.6	46.1	46.3	47.1	47.2	-	-	-	-	-	-	30
	30	31.7	38.4	42.1	43.1	44.4	44.6	45.9	46.3	47.1	47.5	47.7	47.9	-	-	30
	60	-	31.8	37.5	38.7	40.9	42.3	43.3	44.5	45.4	46.4	46.8	47.1	-	-	30
FR2	60	-	-	-	-	-	-	-	33.7	-	-	-	34.5	34.9	-	30
	120	-	-	-	-	-	-	-	31.7	-	-	-	34.0	34.7	35.0	30

### Uplink

Similarly, based on the formula provided in Eq. (1), the UL peak spectral efficiency for NR is derived here. The TDD UL peak spectral efficiency for NR TDD for different bandwidth and SCS parameters is evaluated for the same DL dominant frame structure “DDDSU”.

Table 2-5 Parameter assumptions of NR UL peak spectral efficiency

Parameters	Values	Remarks
$v_{Layers}^{(j)}$	4	NR supports up to 4 layers for a single user for UL
$Q_m^{(j)}$	8	NR supports up to 256QAM for UL
$f^{(j)}$	1	The value of 1 is chosen as scaling factor for UL peak spectral efficiency evaluation.
$R_{max}$	$948/1024 = 0.9258$	NR supports highest coding rate as $R_{max}=948/1024$ .
$\mu$	0, 1, 2, 3	SCS $\Delta f = 2^\mu \cdot 15$ [kHz]
$N_{PRB}^{BW(j),\mu}$	For FR1: <ul style="list-style-type: none"> <li>• 270 for 50MHz with 15kHz SCS</li> <li>• 273 for 100MHz with 30kHz SCS</li> <li>• 135 for 100MHz with 60kHz SCS</li> </ul> For FR2: <ul style="list-style-type: none"> <li>• 264 for 200MHz with 60kHz SCS</li> <li>• 264 for 400MHz with 120kHz SCS</li> </ul>	See Section 5.3.2 of TS38.104
$T_s^\mu$	$T_s^\mu = \frac{10^{-3}}{14 \cdot 2^\mu}$	SCS $\Delta f = 2^\mu \cdot 15$ [kHz]
$BW^{(j)}$	See Section 2.3.	See Section 5.3.2 of TS38.104
$\alpha_{UL}^{(j)}$	0.2357	This value corresponds to DL:UL=4:1, where 3 DL slots, 1 S slot mixing DL/UL symbols, and 1 UL slot are configured in every 5 slots; S slot includes 11 DL symbols, one symbol for GP, and two UL symbols.
$OH^{(j)}$	For FR1: <ul style="list-style-type: none"> <li>• 0.167 for 50MHz with 15kHz SCS</li> <li>• 0.16 for 100MHz with 30kHz SCS</li> <li>• 0.156 for 100MHz with 60kHz SCS</li> </ul> For FR2: <ul style="list-style-type: none"> <li>• 0.202 for 200MHz with 60kHz SCS</li> <li>* 0.195 for 400MHz with 120kHz SCS</li> </ul>	50% of GP symbols are considered as uplink overhead. For FR1: <ul style="list-style-type: none"> <li>• PUCCH: short PUCCH with 1 PRB and 1 symbol in every UL slot</li> <li>• DM-RS: 12 RE/PRB/slot</li> <li>• SRS: 1 symbols per slot with periodicity of 20 ms</li> </ul> For FR2: <ul style="list-style-type: none"> <li>• PUCCH: short PUCCH with 1 PRB and 1 symbol in every UL slot</li> <li>• DM-RS: 12 RE/PRB/slot</li> <li>• SRS: 1 symbols per slot with periodicity of 5ms</li> </ul> PTRS: 2 ports PTRS, frequency density is 4 PRB, and time domain density is 1 symbol

The achievable peak spectral efficiency is shown in the following table.

Table 2-6 NR TDD UL peak spectral efficiency (bit/s/Hz) for the same DDDSU

SCS (kHz)		Channel Bandwidth (MHz)														Req
		5	10	15	20	25	30	40	50	60	80	90	100	200	400	
FR1	15	20.6	21.5	21.8	22.0	22.0	22.1	22.1	22.4	-	-	-	-	-	-	15
	30	18.2	20.0	21.1	21.3	21.7	21.7	22.2	22.2	22.6	22.7	22.8	22.8	-	-	15
	60	-	18.3	20.0	20.1	20.8	20.8	21.4	21.8	22.1	22.5	22.6	22.7	-	-	15
FR2	60	-	-	-	-	-	-	-	20.9	-	-	-	21.0	21.0	-	15
	120	-	-	-	-	-	-	-	20.4	-	-	-	21.1	21.2	21.2	15

## Evaluation Report

Minimum technical performance requirements item	Category	Required value	Value	Requirement met?
5.2.4.3.2 Peak spectral efficiency (bit/s/Hz) (4.2)	eMBB	DL :30	31.7 - 47.9	Yes
		UL : 15	18.2 - 22.8	Yes

### 2.2.1.2 PEAK DATA RATE

#### Requirements

The minimum requirements for peak data rate are as follows:

Performance Measure	ITU Requirements
Peak data rate	DL: 20 Gb/s UL: 10 Gb/s

#### Evaluation Methodology

The proponent should report the peak data rate value achievable by the candidate RITs/SRITs and identify the assumed frequency band(s) of operation, the maximum assignable channel bandwidth in that band(s) and the main assumptions related to the peak spectral efficiency over the assumed frequency band(s) (e.g. antenna configuration).

Proponents should demonstrate that the peak data rate requirement can be met for, at least, one carrier frequency or a set of aggregated carrier frequencies (where it is the case), assumed in the test environments under the eMBB usage scenario.

#### Results

##### Downlink

When assessing the downlink peak data-rate, the overheads due to SSB, TRS, PDCCH, DM-RS, PT-RS and CSI-RS must be considered. These are shown in table below.

To achieve peak data rates of 20 Gbits/s, bandwidths of the order of 400 MHz are required, so the evaluation focuses on frequencies above 6 GHz.

Table 2-7 Evaluation assumptions for peak data-rate (FR2)

Parameter	Configuration
SSB (synchronization signal block)	8 SSBs per 20 ms
TRS (tracking reference signal)	Minimum (52, BW in PRBs) PRB wide, occurs every 20 ms
PDCCH (physical downlink control channel)	4 CCE in every slot
DM-RS (demodulation reference signal)	2 complete symbols per slot
CSI-RS (channel-state information reference signal)	8 RE per PRB, occurs every 10 ms
PT-RS (phase-tracking reference signal)	1 subcarrier every 4 <sup>th</sup> PRB, every symbol
Number of layers	8
Modulation format	256QAM
Code rate	0.93

Using the MATLAB formulation given below evaluates the peak data rate with the above assumption and 3GPP references <sup>5,6</sup>

$$DR_{dl} = \text{repmat}(N_{\text{slots/s}}, N_{\text{rows}}, \text{size}(BW_{SC}, 2)) * N_{RE/\text{slot}} * (1 - OH_{dl}) * N_{\text{layers}} * \text{Mod}_{\text{format}} * CR$$

where

$DR_{dl}$  = data-rate on the DL

$B = \text{repmat}(A, m, n)$  creates a large matrix B consisting of an m-by-n tiling of copies of A

$s = \text{size}(A)$  returns a row vector whose elements contain the length of the corresponding *dimension* of A

$N_{RE}$  = no of resource elements

$OH_{dl}$  = overhead on the DL

For more details about the formula itself, the reader is referred to 3GPP references <sup>6</sup>.

For a 400 MHz wide component carrier, the peak data rate is **17.49 Gbits/s**. Aggregating two such component carriers consume a bandwidth of 800 MHz and gives a peak data-rate of about **35 Gbits/s**, well beyond the passing criterion of 20 Gbits/s.

Table 2-8 Downlink peak data-rate in Gbps (1 CC)

SCS \ BW	50 MHz	100 MHz	200 MHz	400 MHz	6400 MHz
60 kHz	2.11	4.32	8.73	-NA-	-NA-
120 kHz	1.98	4.25	8.66	17.49	16 CC each of 400 MHz required 16x17.49=279.84

According to Section 6.4 of TS38.331, carrier aggregation of up to sixteen component carriers is supported by NR Rel-15. Accordingly, the NR capability of maximum aggregated system bandwidth is presented in Table 8.1.1-1. of TR 37.910 It is observed that the maximum aggregated bandwidth for FR 1 is 800 MHz to 1 600 MHz; while for FR 2, the maximum aggregated bandwidth is 3200 MHz to 6400 MHz

## Uplink

The evaluation parameters for the uplink are listed in Table 3. The overheads due to DM-RS, PT-RS, SRS, and PUCCH are considered. The ITU peak data rate targets are fulfilled for carrier aggregation of two 400 MHz wide component carriers, see Table 4.

<sup>5</sup> R1-1809934, Summary on discussion on IMT-2020 evaluation for peak data rate and peak spectral efficiency,” Huawei

<sup>6</sup> R1-1805641, “Way Forward on NR Peak Data Rate Formula,” Intel, Samsung, MediaTek, Huawei, HiSilicon, Apple, Vivo, OPPO

Table 2-9 Evaluation Assumptions for peak data-rate for uplink

Parameter	Setting
DM-RS	1 complete symbol per slot
PT-RS	1 subcarrier every 4 <sup>th</sup> PRB, every symbol
SRS	1 complete symbol every 10 ms
PUCCH	Long PUCCH with 2 PRB over slot in every slot
Number of layers	4
Modulation format	256QAM
Code rate	0.93

Table 2-10 Uplink peak data-rate in Gbps (per CC)

	50 MHz	100 MHz	200 MHz	400 MHz	Aggregated BW 6400MHz. - (date-rate)
<b>60 kHz</b>	1.16	2.35	4.74	-NA-	-NA-
<b>120 kHz</b>	1.08	2.31	4.71	9.50	16 CC each of 400 MHz required 16x9.50=152.0Gbps

## Evaluation Report

Minimum technical performance requirements item	Category	Required value	Value(2)	Requirement met?	Comment
5.2.4.3.1 Peak data rate (Gbit/s) (4.1)	eMBB	Downlink: 20	21.74-34.98	Yes	Using multiple CC for BW 500-800MHz
	Environment: specific	No Uplink: 10	11.81-19	Yes	By using multiple component Carriers for aggregate BW of 500MHz-800MHz in FR2

### 2.2.1.3 USER EXPERIENCED DATA RATE

#### Requirements

The system performance in terms of user-experienced data-rate is to be evaluated in the DU geographic environment. The target values are set as

Performance Measure	ITU Requirements
User Experienced Data rate	DL: 100 Mbps UL: 50 Mbps

#### Evaluation Methodology

The IMT-2020 technical requirement on user-experienced data-rate is defined as the 5% point of the cumulative distribution function of the user throughput, which, in turn, represents the number of correctly received bits, i.e. the number of bits contained in the service data units delivered to layer 3, over a certain period of time.

In the case of one frequency band and one layer of transmission reception points (TRxP), the user-experienced data-rate is computed as

$$R_{\text{user}} = W \cdot SE_{5\%}$$

where  $SE_{5\%}$  is the 5th percentile user spectral efficiency and  $W$  denotes the channel bandwidth.

In case bandwidth is aggregated across multiple bands (one or more TRxP layers), the user-experienced data-rate will be summed over the bands. Similar is the case when using carrier aggregation to derive user-experienced data-rate.

These values are defined assuming supportable bandwidth for each test environment. However, the bandwidth assumption is not part of the requirement; and hence the required bandwidth has been reported as part of the evaluation effort in the following.

## Results

We have evaluated the User Experienced Data Rate in Dense Urban eMBB test environment for Configuration A (4 GHz). For the 5th Percentile Spectral Efficiency evaluation assumptions and detailed results see (Section 2.2.3.1-A)

Table 2-11 reproduced below is the downlink 5% spectral efficiency evaluated for config-A (4GHz) for different bandwidth and antenna configurations and the corresponding User Experienced Data Rate for both Uplink and Downlink.

*Table 2-11 TDD DL spectral efficiency evaluation for different system bandwidth in FRI*

Dense Urban	Evaluation config A	1-CC Bandwidth		
		BW=20 MHz	BW=40 MHz	BW=100 MHz
DL	Config. A (30KHz SCS); 32T4R ((5% SE))	0.375	0.437	0.479
	User Experience Calculation(Mbps)	14 CC (280 MHz) $14 \times 20 \times 0.375 = \mathbf{105}$	6 CC (240 MHz) $6 \times 40 \times 0.437 = \mathbf{104.88}$	3 CC (300 MHz) $3 \times 100 \times 0.479 = \mathbf{143.7}$
	Config. A (30KHz SCS); 64T4R (5% SE)	0.485	0.568	0.624
	User Experience Calculation(Mbps)	11 CC (220 MHz) $11 \times 20 \times 0.485 = \mathbf{106.7}$	5 CC (200 MHz) $5 \times 40 \times 0.568 = \mathbf{113.6}$	3 CC (300 MHz) $3 \times 100 \times 0.624 = \mathbf{187.2}$
UL	Config. A (30KHz SCS); 4T32R (5% SE)	0.3	0.312	0.334
	User Experience Calculation (Mbps)	9 CC (180 MHz) 54	4 CC (160 MHz) $4 \times 40 \times 0.312 = 50$	2 CC (300 MHz) $2 \times 100 \times 0.334$

				=66.8
	Config. A (30KHz SCS); 4T64R (5% SE)	0.386	0.401	0.429
	User Experience Calculation(Mbps)	7 CC (140 MHz) $7 \times 20 \times 0.486$ =54	3CC (120 MHz) $3 \times 40 \times 0.401=48$	3 CC (300 MHz) $3 \times 100 \times 0.429$ =128.7

3GPP Self-Evaluation Report provides support for up to 16 CC aggregation and the User Experienced Data Rate for maximum available bandwidth is provided in Table 2-12.

Table 2-12 Downlink - Maximum User Experienced Data Rate for different possible Aggregated Bandwidth

Dense Urban	Evaluation config.	User Experienced Data Rate (Mbps)(>50) = (Ncc×W×SE_5)	
		W = 180 MHz	W= 1,600 MHz
DL	Config. A (30KHzSCS); 64T4R	3 CC required 100×0.624 + 80×0.568 =107.84	16 CC required 16×100×0.624 =998.4
UL	Config. A (30KHz SCS); 4T64R	3 CC required 100×0.429 + 80×0.401 =74.98	16 CC required 16×100×0.429 =686.4

### Evaluation Report

Minimum technical performance requirements item	Category	Required value	Values	Requirement met?	Comments
5.2.4.3.3 User experienced data rate (Mbit/s) (4.3)	eMBB-DenseUrban	Downlink : 100 Uplink : 50	<b>Downlink 107.8-187.2</b> <b>Uplink: 74.98-128.7</b>	Yes	Corresponds to <u>minimum</u> aggregated bandwidth of 3CC~180MHz for Config A(4GHz) and using 3CC (300MHz) in 4GHz band Note upto 16CC is supported in the technology for achieving higher user experienced date rate

### 5GIF Observations

Based on the assessment,

- i. Multiple carrier aggregation configurations are supported and can be used to improve spectrum utilization and hence User Experienced Data Rate by using higher bandwidth carriers to reduce guard bands and overheads.
- ii. The maximum possible User Experienced Data Rate for 3GPP for 16 CC configuration is 998.2Mbps in DL and 686.4Mbps in UL in FR1, for the given Dense Urban IMT-2020 evaluation configuration
- iii. By employing Carrier Aggregation it can be seen that the minimum bandwidth required in case of DL can be approximated to 180 MHz (100×0.624 + 2×40×0.568=107.84Mbps) when using 64T4R with one 100 MHz Carrier and two 40 MHz Carrier which are available for use in the n77 band (3300-4200 MHz)
- iv. In case of UL User Experienced Data Rate, by using Carrier Aggregation it can be seen that the **minimum bandwidth** required can be approximated to **120 MHz** (100×0.429 + 20×0.386=50.62) when using 4T64R\* with one 100 MHz Carrier and one 20 MHz Carrier which are available for use in the n77 band (3300-4200 MHz)



This assures that Indian operators are well positioned to address the NDCP<sup>7</sup> requirement using this candidate technology (IMT-2020/14), using a minimum bandwidth of 180 MHz in n77 Band.

### 2.2.1.4 AREA TRAFFIC CAPACITY

#### Requirements

*Area traffic capacity* is defined as the total traffic throughput served per geographic area (in Mbits/s/m<sup>2</sup>). The throughput is the number of correctly received bits, i.e. the number of bits contained in the service data units delivered to layer 3, over a certain period of time.

The requirement is defined for the purpose of evaluation in the Indoor Hotspot (InH) eMBB test environment, where the target value for the **area traffic capacity on the downlink is 10 Mbits/s/m<sup>2</sup>**.

#### Evaluation Methodology

The evaluation is conducted in Indoor Hotspot-eMBB test environment where a single band is considered. Area traffic capacity is derived based on the achievable average spectral efficiency, TRxP density and bandwidth. Let  $W$  denote the channel bandwidth and  $\rho$  the TRxP density (TRxP/m<sup>2</sup>). The area traffic capacity  $C_{area}$  is related to average spectral efficiency  $SE_{avg}$  as follows:

$$C_{area} = \rho \times W \times SE_{avg}$$

In case multiple bands are aggregated, the area traffic capacity will be summed over the bands.

#### Results

We derive the evaluation results of area traffic capacity in Indoor Hotspot eMBB for Config A\* (4 GHz) based on the average spectral efficiency evaluated in (Section 2.2.3.1-A.) for detailed assumptions regarding Average Spectral Efficiency.

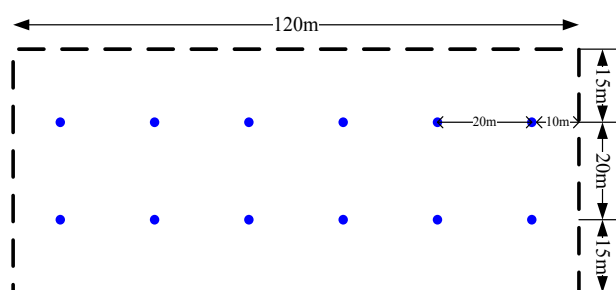

Figure 2.1 Indoor Hotspot site Layout

Based on the Indoor Hotspot network layout as defined in Report ITU-R M.2412, the **TRxP density** is calculated as follows:

$$\rho \text{ (TRxP/m}^2\text{)} = \frac{\text{Number of TRxP}}{\text{Total Area of the network layout}}$$

	<b>12 TRxP</b>	<b>36 TRxP</b>
$\rho \text{ (TRxP/m}^2\text{)}$	0.002	0.006

where the total area of the network layout is  $120 \times 50 = 6,000 \text{m}^2$ .

*Downlink area traffic capacity (Mbit/s/m<sup>2</sup>) in Indoor Hotspot-eMBB at 4GHz, Ch.Model-A*

<sup>7</sup> National Digital Communication Policy - 2018

System bandwidth W(MHz)	DL Average spectral efficiency $SE_{avg}$ [bps/Hz/TRxP]	<b>Area Traffic Capacity</b>	Remark
	TDD 100 MHz bandwidth per Carrier Component(CC) with 30 kHz SCS	DDDSU : 54 DL out of 70 Symbols $SE_{eff}=SE_{avg}*(54/70)$ $W*\rho*SE_{eff}$	
500	13.657	10.54	12TRxP
300	13.637	18.94	36TRxP
DDDSU : D=Downlink Slot, S=Special Slot (11 Downlink Symbols, 2 Gap Symbols, 1 Uplink Symbol), U=Uplink Slot			

## Evaluation Report

Minimum technical performance requirements item	Category	Required value	Value(2)	Requirement met?	5GIF Comments
5.2.4.3.6 Area traffic capacity (Mbit/s/m <sup>2</sup> ) (4.6)	eMBB (Indoor-Hotspot)	10	12 TRxP – 10.54 Mbits/sec/ m <sup>2</sup>  36 TRxP – 18.94 Mbits/sec/ m <sup>2</sup>	Yes	Target met using a Minimum Bandwidth of 300 MHz. (FR1-4GHz)

### 5GIF Observations

- i. Three component carriers of 100 MHz are needed to be aggregated in n77 from the Indian perspective to satisfy the dense Indoor area traffic capacity requirement
- ii. The available bandwidth in the Sub 6 mid band (3300-3600 MHz) is less than the minimum required 300 MHz threshold, but the requirements can be met by employing a higher density of TRxP per Cell

### 2.2.1.5 CONTROL PLANE LATENCY

Control plane latency, also known as call setup latency, is the latency for a User Equipment (UE) to transition to a state where it can send/receive data.

### Requirements

According to Report ITU-R M.2410, control plane latency refers to the transition time from a most “battery efficient” state (e.g. Idle state) to the start of continuous data transfer (e.g. Active state). This requirement is defined for the purpose of evaluation in the eMBB and URLLC usage scenarios. The minimum requirement for control plane latency is 20ms.

Technical performance requirement	Value (ms)
Control plane latency for eMBB (ms)	20
Control plane latency for URLLC (ms), <i>10ms recommended</i>	

### Evaluation Methodology

The proponent should provide the elements and their values in the calculation of the control plane latency. Table below from the M.2412 provides an example of the elements in the calculation of the control plane latency.

**Example of control plane latency analysis template**

Step	Description
1	Random access procedure
2	UL synchronization
3	Connection establishment + HARQ retransmission
4	Data bearer establishment + HARQ retransmission
	Total control plane latency = Sum of 1) to 4)

### Results

In 3GPP, Radio Connection between UE and Network is done through RRC re configuration. It is necessary to study the transition of states and exchange of signals during the Radio Resource Control configuration. RRC Inactive state to the RRC Active state transition is shown in the figure below:

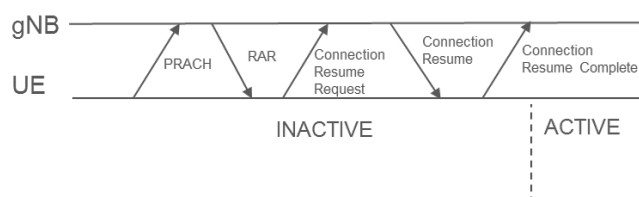

#### Processing Delay:

In our evaluation, the assumption is that the minimum timing capabilities have been agreed for NR. With the UE capability, the minimum UL timing is set to be 3 symbols for both 15 kHz and 30 kHz SCS. For 120kHz, the assumption is made of 9 symbols timing.

For the case of URLLC scenario, where low latency is required for the user-plane, the network allows transmission of mini-slots, where the TTIs can have shorter and different lengths and we have therefore counted the processing in terms of the shortest considered TTI, which is 4 symbols (for e.g. TTI = 1ms, 0.5ms and 0.25ms for SCS=15,30 & 60 respectively, for a 14OFDM symbol in TTI, will be scaled down by 28.5% for 4symbol)

For simplicity, the processing delay is therefore set to 1 TTI for both 15 and 30 kHz SCS and 3 TTI at 120 kHz SCS, in both gNB and UE. The RRC processing delays are assumed to be of a fixed value of 3ms, as discussed in 3GPP reference (R2-1802686, “RRC UE processing time for Standalone NR”, Ericsson)

For the evaluation of latency, it is assumed that the UE works with n+2 timing and the gNB with n+3 timing as the fastest options, i.e. that the processing budget is 1 (15 kHz SCS) and 2 (30kHzSCS) TTIs,. For 120kHz, the processing delay is doubled in TTIs, giving n+3 timing for the UE and n+5 timing for gNB.

### FDD

With the assumptions described above, the resulting CP latency will be as outlined in Table below. As can be seen, the total worst-case delay sums up in the range 9-14 TTIs + 6ms for FDD.

Component	Description	Latency	
		15/30kHz	120kHz

1	Worst-case delay due to RACH scheduling period (1TTI period)	1TTI	1TTI
2	Transmission of RACH Preamble	1TTI	1TTI
3	Preamble detection and processing in gNB	1TTI	3TTI
4	Transmission of RA response	1TTI	1TTI
5	UE Processing Delay (decoding of scheduling grant, timing alignment and C-RNTI assignment + L1 encoding of RRC Connection Request)	1TTI	2TTI
6	Transmission of RRC Connection Resume Request	1 TTI	1 TTI
7	Processing delay in gNB (L2 and RRC)	3 ms	3 ms
8	Transmission of RRC Connection Resume (and UL grant)	1 TTI	1 TTI
9	Processing delay in the UE (L2 and RRC)	3 ms	3 ms
10	Transmission of RRC Connection Resume Complete (including NAS Service Request)	1 TTI	1 TTI
11	Processing delay in gNB (Uu → S1-C)	1 TTI	3 TTI
	<b>Total delay</b>	<b>9 TTI + 6 ms</b>	<b>14 TTI + 6ms</b>

The worst-case Control Plane (CP) latency in 3GPP NR Rel.15 FDD is estimated to be 9TTI+6ms for 15/30kHz SCS and 14TTI+6ms at 120kHz.

**Summary:** CP latency in ms (FDD)

CP latency (ms)	15kHz SCS	30kHz SCS	120kHz SCS
<b>14-symbol TTI</b>	15 (TTI=1ms : 9+6)	10.5	7.8
<b>7-symbol TTI</b>	10.5 (TTI=0.5ms )	8.3	6.9
<b>4-symbol TTI</b>	8.6 (TTI=0.2888ms)	7.3	6.5

It can be noted that by using SCS of 120kHz the NR can have control plane latency <10ms. And also, for typical SCS of 15/30kHz the control plane latency is <20m.

TDD

For the TDD slot sequence, two cases are studied: an alternating UL-DL sequence, and a DL-heavy **UDDD** sequence. Due to the slot sequence, additional alignment delays are added.

As can be seen, the total worst-case delay sums up in the range 12-26 TTI + 6ms for TDD.

Component	Description	Latency(slot) Frame Fomat : UL- DL		Latency(slot) Frame Format : UDDD	
		15/30kHz	120kHz	15/30kHz	120kHz
1	Worst-case delay due to RACH scheduling period (1TTI period)	2 TTI	2 TTI	4 TTI	4 TTI
2	Transmission of <b>RACH Preamble</b>	1 TTI	1 TTI	1 TTI	1 TTI
3	Preamble detection and processing in gNB	1 TTI	3 TTI	1 TTI	3 TTI
4	DL slot alignment	1 TTI	1 TTI	0 TTI	1 TTI
5	Transmission of <b>RA response</b>	1 TTI	1 TTI	1 TTI	1 TTI
6	UE Processing Delay (decoding of scheduling grant, timing alignment and C-RNTI assignment + L1 encoding of RRC Connection Request)	1 TTI	3 TTI	1 TTI	3 TTI
7	UL slot alignment	1 TTI	1 TTI	0 TTI	3 TTI
8	Transmission of <b>RRC Connection Resume Request</b>	1 TTI	1 TTI	1 TTI	1 TTI
9	Processing delay in gNB (L2 and RRC)	3 ms	3 ms	3 ms	3 ms
10	DL slot alignment	1 TTI	1 TTI	0 TTI	1 TTI
11	Transmission of <b>RRC Connection Resume</b> (and UL grant)	1 TTI	1 TTI	1 TTI	1 TTI
12	Processing delay in the UE (L2 and RRC)	3 ms	3 ms	3 ms	3 ms
13	UL slot alignment	1 TTI	1 TTI	0 TTI	3 TTI
14	Transmission of <b>RRC Connection Resume Complete</b> (including NAS Service Request)	1 TTI	1 TTI	1 TTI	1 TTI
15	Processing delay in gNB (Uu → S1-C)	1 TTI	3 TTI	1 TTI	3 TTI
	<b>Total delay</b>	<b>14 TTI + 6 ms</b>	<b>20 TTI + 6 ms</b>	<b>12 TTI + 6 ms</b>	<b>26 TTI + 6 ms</b>

The worst-case CP latency in NR Rel-15 TDD is with alternating UL-DL pattern and is 14TTI+6ms.

With different TTI lengths and SCSs, the absolute delay will differ, as shown in Tables below.

**Summary:** CP latency in ms (TDD)

CP latency (ms)	UL-DL (Alternate U/D)			UDDD (Downlink centric)		
	15kHz SCS	30kHz SCS	120kHz SCS	15kHz SCS	30kHz SCS	120kHz SCS
<b>14-symbol TTI</b>	20	13	8.5	18	12	9.3
<b>7-symbol TTI</b>	13	9.5	7.3	12	9.0	7.6
<b>4-symbol TTI</b>	10	8.0	6.7	9.4	7.7	6.9

## Evaluation Report

Minimum technical performance requirements item	Category	Required value	Value	Requirement met?	Comment
5.2.4.3.8 Control plane latency (ms) (4.7.2)	eMBB	20	8.5-20	Yes	various TTI duration, flexible UL & DL format and SCS allows to achieve CP latency below 20ms in both FDD & TDD
	URLLC	20	6.5-10	Yes	

### 2.2.1.6 USER PLANE LATENCY

User plane latency is the average time between the first transmission of a data packet and the reception of a physical layer ACK. While the control plane latency involves the network attachment operation, the user plane latency only considers the latency of packets while the UE is already in a connected state.

#### Requirements

According to Report ITU-R M.2410, User Plane (UP) latency is “the one-way time taken to successfully deliver an application layer packet/message from the radio protocol layer 2/3 SDU ingress point to the radio protocol layer 2/3 SDU egress point of the radio interface in either uplink or downlink.”

Technical performance requirement	Value
User plane latency for eMBB (ms) For UL & DL	4ms
User plane latency for URLLC (ms) For UL & DL	1ms

#### Evaluation Methodology

The proponent should provide the elements and their values in the calculation of the user plane latency, for both UL and DL. The table provides an example of the elements in the calculation of the user plane latency.

Example of user plane latency analysis template should be aggregation of

- 1) UE Processing Delay
- 2) Frame Alignment
- 3) TTI for data packet transmission
- 4) HARQ Retransmission
- 5) BS Processing Delay

#### Results

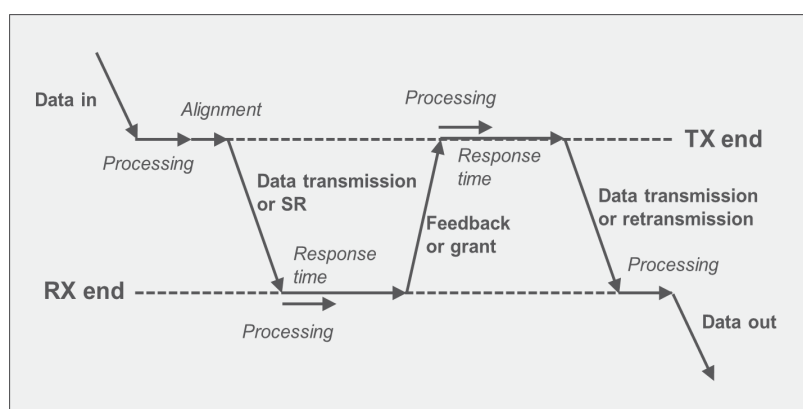

Figure 2.2 Illustration of latency components for DL and UL data

#### Processing delay

This is the delay caused at the transmitter by preparation of the transmission and at the receiver by reception procedures and decoding.

On the DL, the processing delay in the UE includes the reception and decoding procedure. On the UL, there is also processing delay in the UE due to reception and decoding of the uplink grant. In gNB there is also processing delay as in the UE, with the addition that processing delay in the gNB also comprises delay caused by scheduling.

### Alignment delay

The alignment delay is the time required after being ready to transmit until transmission actually starts. The assumption is the worst-case latency meaning the alignment delay is assumed to be the longest possible. PDCCH and PUCCH opportunities are assumed to be every scheduled TTI.

### gNB timing

The minimum response time in the gNB between Scheduling Request (SR) and UL grant, and between DL HARQ and re-transmission, is assumed to be  $1 TTI$ . For higher SCS and fewer symbols in the mini-slot, the TTI is shorter, and more TTIs should be used for processing. The processing in gNB consists of three main components:

- Reception processing (PUSCH processing, SR/HARQ-ACK processing)
- Scheduling processing (including SDU/PDU processing for DL)
- L1 preparation processing for PDSCH and PDCCH

For simplicity the gNB processing time is referred to as the total processing time and further this processing time is equal for the cases that can occur. For example, the same processing time is assumed for scheduling first transmission and re-transmission. Same processing time is also assumed for DL and UL. The processing time is a lower limit for gNB response time, where the assumptions on gNB processing time are given below:

*Processing time (in # of OFDM symbols) assumptions for gNB.*

Timing	15/30kHz SCS			120kHz SCS		
	7os TTI	4os TTI	2os TTI	7os TTI	4os TTI	2os TTI
<b>gNB processing</b>	7	4	4	14	12	10

### UE timing

The minimum response timing in the UE between DL data and DL HARQ, and between UL grant and UL data. On the DL, the UE processing time is according to  $N_1$  (see Table below) while on the UL, the UE processing time is according to  $N_2$  (see Table below) for UE capability 2.

#Symbols	$N_1$ PDSCH (front-loaded DMRS)			$N_2$ PUSCH preparation time		
	15kHz SCS	30kHz SCS	120kHz SCS	15kHz SCS	30kHz SCS	120kHz SCS
<b>Capability 2</b>	3	4.5	20*	5	5.5	36*
<b>NOTE</b>	* In NR Rel. 15 no value (lower than for Capability 1) for 120 kHz SCS was agreed. – $N_1$ : PDSCH processing time in OFDM symbols for the UE capabilities with front-loaded DM-RS. – $N_2$ : PUSCH preparation procedure time					

### UL scheduling

For UL data, the scheduling can either be based on SR (Scheduling Request) or SPS (Semi Persistent scheduling) UL. The assumption is that SR periodicity is 2os corresponding to the shortest periodicity allowed.

### TTI length and pattern

In this evaluation, slot lengths of 14 symbols as well as mini-slots of 7, 4, and 2 symbols are considered. For TDD, an alternating DL-UL pattern has been assumed, to represent the most latency-optimized setup in a carrier. With TDD, slot/mini-slots of 14, 7, and 4 symbols are studied.



## FDD

For the case of FDD, the HARQ RTT is  $n+k$  TTI according to Table 6.3.1 (gNB processing Time). The resulting UP latency for SCS of 15, 30 and 120 kHz is shown in Table below. As can be seen, the 1ms requirement can be reached for SCS 15kHz and up depending on mini-slot configuration. On the UL, “configured” grants (CG) reduce the latency considerably compared to SR-based scheduling.

Table 2-13 FDD UP one-way latency for data transmission with HARQ-based retransmission, compared to the 1ms (URLLC - green) and 4ms (eMBB-orange) requirements.

Latency (ms)	HARQ	15kHz SCS				30kHz SCS				120kHz SCS			
		14-os TTI	7-os TTI	4-os TTI	2-os TTI	14-os TTI	7-os TTI	4-os TTI	2-os TTI	14-os TTI	7-os TTI	4-os TTI	2-os TTI
DL data	1 <sup>st</sup> transmission	3.2	1.7	1.3	0.86	1.7	0.91	0.7	0.48	0.55	0.43	0.38	0.31
	1 retx	6.2	3.2	2.6	1.7	3.1	1.6	1.3	0.96	1.1	0.87	0.76	0.63
	2 retx	9.2	4.7	3.6	2.6	4.7	2.4	2	1.5	1.6	1.3	1.1	0.96
	3 retx	12	6.2	4.6	3.4	6.1	3.1	2.7	2	2.1	1.7	1.5	1.3
UL data (SR)	1 <sup>st</sup> transmission	5.5	3	2.5	1.8	2.8	1.5	1.3	0.93	1.2	1.1	1	0.89
	1 retx	9.4	4.9	3.9	2.6	4.7	2.4	2	1.4	1.9	1.7	1.6	1.3
	2 retx	12	6.4	4.9	3.5	6.2	3.2	2.6	1.9	2.6	2.3	2.1	1.8
	3 retx	15	7.9	5.9	4.4	7.7	3.9	3.3	2.3	3.2	2.8	2.6	2.2
UL data (CG)	1 <sup>st</sup> transmission	3.4	1.9	1.4	0.93	1.7	0.95	0.7	0.48	0.7	0.57	0.52	0.45
	1 retx	6.4	3.4	2.6	1.8	3.2	1.7	1.4	0.93	1.3	1.1	1.1	0.89
	2 retx	9.4	4.9	3.9	2.6	4.7	2.4	2	1.4	1.9	1.7	1.6	1.3
	3 retx	12	6.4	4.9	3.5	6.2	3.2	2.6	1.9	2.6	2.3	2.1	1.8

### Summary for FDD

#### eMBB

- can meet both 4ms UP latency on DL even with SCS15kHz
- can meet the 4ms UP latency on UL with Scheduled Request at SCS=15kHz, but 1ms UP latency are achievable in limited configurations.

#### URLLC

- can meet the 1ms UP latency on DL using *mini-slots* at SCS=15kHz
- can meet 1ms UP latency on UL using “*configured Grants*” at SCS=15kHz and mini-slots

## TDD

With TDD, there are additional alignment delays caused by the sequence of DL and UL slots. Depending on when the data arrives in the transmit buffer, the latency may be the same or higher than the FDD latency. For a DL-UL pattern with HARQ RTT of  $n+4$  TTI and higher, the resulting latency is as indicated in Table below.

As can be seen in the table, the 4ms target can be reached with a SCS of 15kHz for 7-symbol mini slot, while 30 kHz SCS is possible also with slot length transmission. The 1ms target can be reached with 120kHz SCS and mini-slots for DL and UL configured grant transmissions.

*Table 2-14 TDD UP one-way latency for data transmission with alternating DL-UL slot pattern, compared to the 1ms (URLLC-green) and 4ms (eMBB-orange) requirements*

Latency (ms)	HARQ	15kHz SCS			30kHz SCS			120kHz SCS		
		14-os TTI	7-os TTI	4-os TTI	14-os TTI	7-os TTI	4-os TTI	14-os TTI	7-os TTI	4-os TTI
DL data	1 <sup>st</sup> transmission	4.2	2.7	2.3	2.2	1.4	1.2	0.68	0.55	0.51
	1 retx	8.2	4.7	4.3	4.1	2.4	2.2	1.4	1.1	1
	2 retx	12	6.7	6.3	6.2	3.4	3.2	2.2	1.6	1.5
	3 retx	16	8.7	8.3	8.1	4.4	4.2	2.9	2.1	2
UL data (SR)	1 <sup>st</sup> transmission	7.5	4.5	4.1	3.8	2.3	2.1	1.5	1.2	1.2
	1 retx	12	6.9	6.4	6.2	3.4	3.2	2.3	1.9	1.7
	2 retx	16	8.9	8.4	8.2	4.5	4.2	3.1	2.5	2.2
	3 retx	20	11	10	10	5.4	5.2	3.8	3.2	2.7
UL data (CG)	1 <sup>st</sup> transmission	4.4	2.9	2.4	2.2	1.4	1.2	0.82	0.7	0.64
	1 retx	8.4	4.9	4.4	4.2	2.5	2.2	1.6	1.3	1.2
	2 retx	12	6.9	6.4	6.2	3.4	3.2	2.3	1.9	1.7
	3 retx	16	8.9	8.4	8.2	4.5	4.2	3.1	2.5	2.2

## Evaluation Report

Minimum technical performance requirements item	Category	Required value	Value(2)	Requirement met?	Comment
5.2.4.3.7 User plane latency (ms) (4.7.1)	eMBB (DL & UL)	4	0.86-3.9	Yes	Using various TTI duration (mini-slots), flexible UL & DL format and SCS allows to achieve UP latency in both FDD & TDD
	URLLC (DL & UL)	1	0.31-0.96	Yes	

### 2.2.1.7 MOBILITY INTERRUPTION TIME

Mobility interruption time is the shortest time taken during mobility transitions, where user terminal cannot exchange any user packets with any base station, which includes the time required to execute any radio access network procedure, radio resource control signalling protocol, or other message exchanges between the mobile station and the radio access network.

#### Requirements

For seamless transition, 0 ms mobility interruption time is an essential requirement.

Performance Measure	ITU Requirements
Mobility Interruption time	0ms

#### Evaluation Methodology

The procedure of exchanging user plane packets with base stations during transitions shall be described based on the proposed technology including the functions and the timing involved.

#### Results

Mobility interruption time can be evaluated using two schemes supported by 3GPP NR - Beam mobility and Carrier Aggregation (CA).

##### Beam Mobility

In the beam mobility scenario, when moving within the same cell, the transmit-receive beam pair of the user equipment needs to be changed.

gNB configures different beams for the UE at different slots during UE mobility for DL data transmission.

UE and gNB allocate different beams between them for continuous DL transmission. Since there are different beams, even if one link fails, the other link maintains a connection as beam pair switching happens at different slots.

For UL data transmission, PUSCH is sent using the beam configured by SRI (SRS resource indicator) by gNB. The UL communication between gNB and UE is done by selecting a side beam for data transmission by selecting different slots.

##### CA Mobility

When moving within the same PCell (Primary Cell) with CA enabled, the set of configured SCells (Secondary Cells) of the UE may change. The *SCell* addition procedure and *SCell* release procedures can occur.

During these procedures, the UE can always exchange user plane packets with the gNB during transitions, because the data transmission between the UE and the PCell is kept during the transition.

Based on the above analysis and procedures supported by 3GPP NR, the UE can always exchange user plane packets with gNB during the mobility transitions.

Therefore, **0ms** mobility interruption time is achieved by NR for this scenario.

## Evaluation Report

Minimum technical performance requirements item	Category	Required value	Value(2)	Requirement met?	Comment
5.2.4.3.14 Mobility interruption time (ms) (4.12)	eMBB	0	0	Yes	Due to inherent support for Beam Mobility & CA mobility, make before break happens
	URLLC	0	0	Yes	

### 2.2.2 Inspection Aspects

This report is the output of Inspection based evaluation of the candidate technology (3GPP NR) for the following Technical Performance Requirements from M.2410. Inspection is conducted by reviewing the functionality and parameterization of a proposal.

#### 2.2.2.1 BANDWIDTH

Bandwidth is the maximum aggregated system bandwidth. The bandwidth may be supported by single or multiple radio frequency (RF) carriers.

#### Requirements

The bandwidth capability of the RIT/SRIT is defined for the purpose of IMT-2020 evaluation.

- The requirement for bandwidth is at least 100 MHz.
- The RIT/SRIT shall support bandwidths up to 1 GHz for operation in higher frequency bands (e.g. above 6 GHz).
- The RIT/SRIT shall support scalable bandwidth. Scalable bandwidth is the ability of the candidate RIT/SRIT to operate with different bandwidths.

#### Methodology

- The support of maximum bandwidth required in § 4.13 of Report ITU-R M.2410-0, is verified by inspection of the proposal.
- The scalability requirement is verified by demonstrating that the candidate RITs/SRITs can support multiple different bandwidth values. These values shall include the minimum and maximum supported bandwidth values of the candidate RITs/SRITs.
- The requirements for bandwidth or the bandwidth numbers demonstrated by the proponent do not pose any requirements or limitations for other Technical Performance Requirements that depend on bandwidth. If any other requirement requires a higher bandwidth, the capability to reach that bandwidth should be described as well.

### Results

Based on the Section 5.3.2 of 3GPP TS 38.104

	SCS [kHz]	Maximum bandwidth for one component carrier (MHz)	Maximum number of component carriers for carrier aggregation	Maximum aggregated bandwidth (MHz)	Minimum Requirement as per ITU-R	Requirement Met?
FR1	15	50	16	800	100	Yes
	30	100	16	1600		
	60	100	16	1600		
FR2	60	200	16	3200	> 1GHz	Yes
	120	400	16	6400		

## Evaluation Report

Minimum technical performance requirements item (5.2.4.3.x), units, and Report ITU-R M.2410-0 section reference <sup>(1)</sup>	Usage Scenario/Test Environment / Eval Configurations	Required value	Value <sup>(2)</sup>	Requirement met?	Comments <sup>(3)</sup>
5.2.4.3.15 Bandwidth and Scalability (4.13)	-NA-	At least 100 MHz	FR1: Upto 1600MHz	<b>Yes</b>	
		Up to 1 GHz	FR2: upto 6400MHz	<b>Yes</b>	
		Support of multiple different bandwidth values <sup>(4)</sup>	5MHz to 400MHz (in various bands)	<b>Yes</b>	

### 2.2.2.2 ENERGY EFFICIENCY

- **Network energy efficiency** is the capability of a RIT/SRIT to minimize the radio access network energy consumption in relation to the traffic capacity provided.
- **Device energy efficiency** is the capability of the RIT/SRIT to minimize the power consumed by the device modem in relation to the traffic characteristics.

#### Requirements

Network energy efficiency is the capability of a RIT/SRIT to minimize the radio access network energy consumption in relation to the traffic capacity provided. Device energy efficiency is the capability of the RIT/SRIT to minimize the power consumed by the device modem in relation to the traffic characteristics.

Energy efficiency of the network and the device can relate to the support for the following two aspects:

- **Efficient data transmission** in a loaded case;
- **Low energy consumption** when there is no data.

It is estimated by the *sleep ratio*. The sleep ratio is the fraction of unoccupied time resources (for the

network) or sleeping time (for the device) in a period corresponding to the cycle of the control signaling (for the network) or the cycle of discontinuous reception (for the device) when no user data transfer takes place.

Furthermore, the *sleep duration*, i.e. the continuous period with no transmission (for network and device) and reception (for the device), should be sufficiently long.

This requirement is defined for the purpose of evaluation in the eMBB usage scenario.

The RIT/SRIT shall have the capability to support a high sleep ratio and long sleep duration. Proponents are encouraged to describe other mechanisms of the RIT/SRIT that improve the support of energy efficient operation for both network and device.

### **Methodology**

- The energy efficiency for both network and device is verified by inspection by demonstrating that the candidate RITs/SRITs **can support high sleep ratio and long sleep duration** as defined in Report ITU-R M.2410-0 when **there is no data**.
- Inspection can also be used to describe other mechanisms of the candidate RITs/SRITs that improve energy efficient operation for both network and device.

### **5GIF Observation**

Based on the common understanding from ITU-R M.2410 and ITU-R M.2412, Energy Efficiency is to be explicitly evaluated only for the case of low energy consumption when there is no data.

For all bandwidth configurations of the network, a sleep ratio of more than 99% can be achieved at both slot and symbol level; with a minimum of 80% at slot level and 87% at symbol level.

For all the configurations; in idle mode a minimum device sleep ratio of more than 93% can be achieved and for connected mode minimum 84.2% can be achieved.

## Evaluation Report

Minimum technical performance requirements item (5.2.4.3.x), units, and Report ITU-R M.2410-0 section reference <sup>(1)</sup>	Usage Scenario/Test environment	Required value	Value <sup>(2)</sup>	Requirement met?	Comments <sup>(3)</sup>
5.2.4.3.10 Energy efficiency (4.9)	eMBB	Capability to support a high sleep ratio and long sleep duration		Yes	

### 2.2.2.3 SUPPORT OF WIDE RANGE OF SERVICES

#### Requirements

#### Evaluation

There are elements of the minimum technical performance requirements identified within Report ITU-R M.2410-0 that indicate whether the candidate RITs/SRITs are capable of enabling certain services and performance targets, as envisioned in Recommendation ITU-R M.2083.

The support of a wide range of services is verified by inspection of the candidate RITs/SRITs ability to meet the minimum technical performance requirements for various usage scenarios and their associated test environments.



## Evaluation Report

M.2411 Section	<b>Service capability requirements</b>	5GIF comments
5.2.4.1.1	<p>Support for wide range of services Is the proposal able to support a range of services across different usage scenarios (eMBB, URLLC, and mMTC)?: YES / NO</p> <p>Specify which usage scenarios (eMBB, URLLC, and mMTC) the candidate RIT or candidate SRIT can support.</p>	<p>YES, this candidate technology supports a range of services.</p> <p>The RIT supports all three usage scenarios (eMBB, URLLC, and MTC)</p>

### 2.2.2.4 SUPPORTED SPECTRUM BAND(S)/RANGE(S)

#### Requirements

##### Frequency bands identified for IMT

Is the proposal able to utilize at least one frequency band identified for IMT in the ITU Radio Regulations?

Specify in which band(s) the candidate RIT or candidate SRIT can be deployed.

##### Higher Frequency range/band(s)

Is the proposal able to utilize the higher frequency range/band(s) above 24.25 GHz?

Specify in which band(s) the candidate RIT or candidate SRIT can be deployed.

NOTE 1 – In the case of the candidate SRIT, at least one of the component RITs need to fulfil this requirement.

#### Methodology

The spectrum band(s) and/or range(s) that the candidate RITs/SRITs can utilize is verified by inspection.

#### Evaluation Report

	<b>Spectrum capability requirements</b>																		
5.2.4.2.1	<p><b>Frequency bands identified for IMT</b> Is the proposal able to utilize at least one frequency band identified for IMT in the ITU Radio Regulations?: <input checked="" type="checkbox"/> YES / <input type="checkbox"/> NO Specify in which band(s) the candidate RIT or candidate SRIT can be deployed.</p> <p><i>The proponent has identified support for the following bands in their submission.</i></p> <table border="1"> <thead> <tr> <th>NR operating band</th> <th>Uplink (UL) operating band BS receive / UE transmit <math>F_{UL\_low} - F_{UL\_high}</math></th> <th>Downlink (DL) operating band BS transmit / UE receive <math>F_{DL\_low} - F_{DL\_high}</math></th> <th>Duplex Mode</th> </tr> </thead> <tbody> <tr> <td>n1</td> <td>1920 MHz – 1980 MHz</td> <td>2110 MHz – 2170 MHz</td> <td>FDD</td> </tr> <tr> <td>n2</td> <td>1850 MHz – 1910 MHz</td> <td>1930 MHz – 1990 MHz</td> <td>FDD</td> </tr> <tr> <td>n3</td> <td>1710 MHz – 1785 MHz</td> <td>1805 MHz – 1880 MHz</td> <td>FDD</td> </tr> </tbody> </table>			NR operating band	Uplink (UL) operating band BS receive / UE transmit $F_{UL\_low} - F_{UL\_high}$	Downlink (DL) operating band BS transmit / UE receive $F_{DL\_low} - F_{DL\_high}$	Duplex Mode	n1	1920 MHz – 1980 MHz	2110 MHz – 2170 MHz	FDD	n2	1850 MHz – 1910 MHz	1930 MHz – 1990 MHz	FDD	n3	1710 MHz – 1785 MHz	1805 MHz – 1880 MHz	FDD
NR operating band	Uplink (UL) operating band BS receive / UE transmit $F_{UL\_low} - F_{UL\_high}$	Downlink (DL) operating band BS transmit / UE receive $F_{DL\_low} - F_{DL\_high}$	Duplex Mode																
n1	1920 MHz – 1980 MHz	2110 MHz – 2170 MHz	FDD																
n2	1850 MHz – 1910 MHz	1930 MHz – 1990 MHz	FDD																
n3	1710 MHz – 1785 MHz	1805 MHz – 1880 MHz	FDD																

n5	824 MHz – 849 MHz	869 MHz – 894 MHz	FDD
n7	2500 MHz – 2570 MHz	2620 MHz – 2690 MHz	FDD
n8	880 MHz – 915 MHz	925 MHz – 960 MHz	FDD
n12	699 MHz – 716 MHz	729 MHz – 746 MHz	FDD
n20	832 MHz – 862 MHz	791 MHz – 821 MHz	FDD
n25	1850 MHz – 1915 MHz	1930 MHz – 1995 MHz	FDD
n28	703 MHz – 748 MHz	758 MHz – 803 MHz	FDD
n34	2010 MHz – 2025 MHz	2010 MHz – 2025 MHz	TDD
n38	2570 MHz – 2620 MHz	2570 MHz – 2620 MHz	TDD
n39	1880 MHz – 1920 MHz	1880 MHz – 1920 MHz	TDD
n40	2300 MHz – 2400 MHz	2300 MHz – 2400 MHz	TDD
n41	2496 MHz – 2690 MHz	2496 MHz – 2690 MHz	TDD
n51	1427 MHz – 1432 MHz	1427 MHz – 1432 MHz	TDD
n66	1710 MHz – 1780 MHz	2110 MHz – 2200 MHz	FDD
n70	1695 MHz – 1710 MHz	1995 MHz – 2020 MHz	FDD
n71	663 MHz – 698 MHz	617 MHz – 652 MHz	FDD
n75	N/A	1432 MHz – 1517 MHz	SDL
n76	N/A	1427 MHz – 1432 MHz	SDL
n77	3300 MHz – 4200 MHz	3300 MHz – 4200 MHz	TDD
n78	3300 MHz – 3800 MHz	3300 MHz – 3800 MHz	TDD
n79	4400 MHz – 5000 MHz	4400 MHz – 5000 MHz	TDD
n80	1710 MHz – 1785 MHz	N/A	SUL
n81	880 MHz – 915 MHz	N/A	SUL
n82	832 MHz – 862 MHz	N/A	SUL
n83	703 MHz – 748 MHz	N/A	SUL
n84	1920 MHz – 1980 MHz	N/A	SUL
n86	1710 MHz – 1780 MHz	N/A	SUL

*Inference: Thus, the proponents RIT has support for bands identified for IMT-2020.*  
*Note 1: The evaluation group made use of 3GPP TS 38.104 for this inference*  
*Note 2: Text highlighted in blue are possible candidate bands in India, and the 5GIF Evaluation will prioritize our studies on them*

**5.2.4.2.2 Higher Frequency range/band(s)**  
 Is the proposal able to utilize the higher frequency range/band(s) above 24.25 GHz?:  
 YES /  NO  
 Specify in which band(s) the candidate RIT or candidate SRIT can be deployed.  
 NOTE 1 – In the case of the candidate SRIT, at least one of the component RITs need to fulfil this requirement.

*The proponent has identified support for the following bands in their submission.*

NR operating band	Uplink (UL) and Downlink (DL) operating band BS transmit/receive UE transmit/receive $F_{UL\_low} - F_{UL\_high}$ $F_{DL\_low} - F_{DL\_high}$	Duplex Mode
n257	26500 MHz – 29500 MHz	TDD
n258	24250 MHz – 27500 MHz	TDD
n260	37000 MHz – 40000 MHz	TDD
n261	27500 MHz – 28350 MHz	TDD

*Thus, the proponents RIT has support for bands identified for IMT-2020.*

<p><i>Inference: Thus, the proponents RIT has support for bands identified for IMT-2020. Note 1: The evaluation group made use of 3GPP TS 38.104 for this inference.</i></p>
--

## 2.2.3 Simulation Aspects

### 2.2.3.1-A SPECTRAL EFFICIENCY

#### Requirements

eMBB	5th percentile user spectral efficiency		Average spectral efficiency	
	DL (bit/s/Hz)	UL (bit/s/Hz)	DL (bit/s/Hz)	UL (bit/s/Hz)
Indoor Hotspot	0.3	0.21	9	6.75
Dense Urban – eMBB	0.225	0.15	7.8	5.4
Rural – eMBB	0.12	0.045	3.3	1.6
<b>Note:</b> <ul style="list-style-type: none"> <li>– For rural-eMBB, Requirement of 5% SE is not applicable for Config-C (700MHz, ISD=6000m)</li> <li>– For rural-eMBB, Requirement of Avg SE is mandatory for Config-C and one of Config A (700MHz, ISD=1732m) or B (4GHz, ISD=1732m)</li> </ul>				

#### Evaluation Methodology

##### A. 5<sup>th</sup> percentile User Spectral Efficiency

Let user  $i$  in drop  $j$  correctly decode  $R_i^{(j)}(T)$  accumulated bits in  $[0, T]$ . For non-scheduled duration of user  $i$  zero bits are accumulated. During this total time user  $i$  receives accumulated service time of  $T_i \leq T$ , where the service time is the time duration between the first packet arrival and when the last packet of the burst is correctly decoded. In case of full buffer,  $T_i \leq T$ . Hence the rate normalised by service time  $T_i$  and channel bandwidth  $W$  of user  $i$  in drop  $j$ ,  $r_i^{(j)}$ , is:

$$r_i^{(j)} = \frac{R_i^{(j)}(T)}{T_i W}$$

Running  $N$  drops simulations leads to  $N$  drops  $\times N$  values of  $r_i^{(j)}$  of which the lowest 5th percentile point of the CDF is used to estimate the 5th percentile user spectral efficiency.

The 5th percentile user spectral efficiency is evaluated by system level simulation using the evaluation configuration parameters of Indoor Hotspot-eMBB, Dense Urban-eMBB, and Rural-eMBB test environments. It should be noted that the 5th percentile user spectral efficiency is evaluated only using a single-layer layout configuration even if a test environment comprises a multi-layer layout configuration. The 5th percentile user spectral efficiency shall be evaluated using identical simulation assumptions as the average spectral efficiency for that test environment.

The results from the system-level simulation are used to derive the 5th percentile user spectral efficiency as defined in Report ITU-R M.2410-0. The necessary information is the number of correctly received bits per UE during the active session time the UE is in the simulation. The effective bandwidth is the operating bandwidth normalized appropriately considering the uplink/downlink ratio for TDD system. Layer 1 and Layer 2 overheads should be accounted for in time and frequency

##### B. Average spectral efficiency

Let  $R_i(T)$  denote the number of correctly received bits by user  $i$  ( $i = 1, \dots, N$ ) (downlink) or from user  $i$  (uplink) in a system comprising a user population of  $N$  users and  $M$  Transmission Reception Points

(TRxPs). Further, let  $W$  denote the channel bandwidth and  $T$  the time over which the data bits are received. The average spectral efficiency may be estimated by running system-level simulations over number of drops  $N$  drops. Each drop gives a value of  $\sum_{i=1}^N R_i(T)$  denoted as:  $R^{(1)}(T), \dots, R^{(N_{drops})}(T)$  and the estimated average spectral efficiency resulting is given by:

$$\widehat{SE}_{avg} = \frac{\sum_{j=1}^{N_{drops}} R^{(j)}(T)}{N_{drops} T.W.M} = \frac{\sum_{j=1}^{N_{drops}} \sum_{i=1}^N R_i^{(j)}(T)}{N_{drops} T.W.M}$$

where  $SE_{avg}$  is the estimated average spectral efficiency and will approach the actual average with an increasing number of  $N_{drops}$  and  $R_i^{(j)}(T)$  is the simulated total number of correctly received bits for user  $i$  in drop  $j$ .

The average spectral efficiency is evaluated by system level simulation using the evaluation configuration parameters of Indoor Hotspot-eMBB, Dense Urban-eMBB, and Rural-eMBB test environments as defined in this Report. It should be noted that the average spectral efficiency is evaluated only using a single-layer layout configuration even if a test environment comprises a multilayer layout configuration.

The results from the system-level simulation are used to derive the average spectral efficiency as defined in Report ITU-R M.2410-0. The necessary information is the number of correctly received bits per UE during the active session time the UE is in the simulation. The effective bandwidth is the operating bandwidth normalized appropriately considering the uplink/downlink ratio for TDD system.

Layer 1 and Layer 2 overheads should be accounted for in time and frequency. Examples of Layer 1 overhead include synchronization, guard band and DC subcarriers, guard/switching time (for example, in TDD systems), pilots and cyclic prefix. Examples of Layer 2 overhead include common control channels, HARQ ACK/NACK signalling, channel feedback, random access, packet headers and CRC. It must be noted that in computing the overheads, the fraction of the available physical resources used to model control overhead in Layer 1 and Layer 2 should be accounted for in a nonoverlapping way. Power allocation/boosting should also be accounted for in modelling resource allocation for control channels.

Table 2-15 Evaluation configuration for spectral efficiency evaluation

Test env.	Evaluation configuration	Carrier frequency	ISD	Remark
Indoor Hotspot – eMBB	Config. A	4GHz	20m	
	Config B	30GHz		
Dense Urban – eMBB	Config. A	4GHz	200m	Macro layer only
Rural - eMBB	Config. A	700MHz	1732m	
	Config. B	4GHz	1732m	
	Config. C (LMLC)	700MHz	6000m	

The IMT-2020 eMBB spectral efficiency requirement is three times higher compared to IMT-Advanced. Therefore, it is a challenging requirement and thus evaluation of NR has been done to show if it satisfies the requirements. The evaluation is basically applied based on duplexing schemes, i.e., to FDD and TDD, respectively. This is since, duplexing scheme is one of the fundamental features among the other features that impact spectral efficiency performance.

### Duplexing scheme

In NR design, the flexible duplexing scheme is available, e.g.,

- Different transmission directions in either part of a paired spectrum,
- TDD operation on an unpaired spectrum where the transmission direction of most time resources can be dynamically changing.

In this document, the FDD is considered for evaluation configurations with 700MHz and TDD is used for configurations with 4GHz, 30GHz

### Spectral Efficiency calculation (TDD/FDD)

The spectral efficiency of different duplexing schemes can be calculated according to Report ITU-R M.2412.

For DL average spectral efficiency and 5<sup>th</sup> percentile spectral efficiency,

- In case of FDD, the simulation bandwidth is 10 MHz for DL and 10 MHz for UL. The DL average spectral efficiency is given by

$$SE_{avg} = \frac{\sum_{i=1}^N R_i(T)}{T \cdot W \cdot M} \quad (1)$$

where  $W$  is the DL bandwidth of 10 MHz;  $R_i(T)$  denotes the number of correctly received bits of user  $i$ , and the overhead of DL control and DL reference signals on the DL bandwidth of 10 MHz is taken into account when deriving  $R_i(T)$ ; and  $T$  is the simulation time. Similar notations are applied to 5<sup>th</sup> percentile user spectral efficiency.

- For TDD, the simulation bandwidth is 20 MHz for DL and UL. The DL average spectral efficiency is given by (1), where  $W$  is the effective DL bandwidth that accounts for the time-frequency resource used for DL transmission (including GP symbols);  $R_i(T)$  denotes the number of correctly received bits of user  $i$ , and the overhead of DL control, DL reference signal on the DL effective bandwidth is taken into account; and  $T$  is the simulation time. Similar notations are applied to 5<sup>th</sup> percentile user spectral efficiency.

For UL average spectral efficiency and 5<sup>th</sup> percentile spectral efficiency, similar way is employed to derive the evaluation results for these two metrics.

### Spectral efficiency calculation (OH & Guard-band)

To reflect the benefit of reduced guard band ratio and overhead for larger bandwidth in NR, i.e. when the system bandwidth is larger than simulation bandwidth (10 MHz in FDD and 20 MHz in TDD), the spectral efficiency can be derived from Eq. (2)

$$SE' = SE_{avg} \times \frac{(1 - gb(N_{RB}))}{1 - gb(N_{RB0})} \times \frac{(1 - OH(N_{RB}))}{(1 - OH(N_{RB0}))} \quad (2)$$

where  $gb(N)$  and  $OH(N)$  is the guard band ratio and the overhead at given number of RB  $N$ , respectively, and  $SE_{avg}$  is calculated by Eq. (1). For FDD,  $N_{RB0} = 52$  for 10 MHz simulation bandwidth and 15 kHz subcarrier spacing. For TDD,  $N_{RB0} = 51$  for 20 MHz simulation bandwidth and 30 kHz subcarrier spacing.

The overhead reduction for the larger bandwidth mainly comes from the PDCCH. In addition, SSB and TRS overhead will be reduced slightly. By assuming  $M_0$  OFDM symbols for PDCCH at the bandwidth  $BW_0$ , the number of OFDM symbol for PDCCH at bandwidth  $BW$  could be

$$M = BW_0 / BW \times M_0 \quad (3)$$

For example, if we assume  $M_0 = 2$  for 20 MHz bandwidth system, then  $M=1$  for 40 MHz bandwidth system. The value of  $M$  could be a non-integer since NR supports PDCCH sharing with PDSCH.

For the evaluation results in Section 4, the guard band ratio and PDCCH overhead reduction model for larger bandwidth based on Eq. (2) is considered in DL.

## Results

For frequencies in FR1, the 4GHz band is considered for early IMT2020 deployments, this band is a TDD band. In FR2, 30GHz bands are considered for deployment.

Out of the various TDD slot patterns supported by 3GPP NR. Table below shows the parameters used for a DL centric configuration **DDDSU** (i.e. Five slots – 3 slots with all downlink only symbols, Special Slot and one slot with all uplink-only symbols). The Special Slot (S) – has 11 DL symbols, 1 GP (Guard), 2 UL symbols.

### Downlink SE

Evaluation Assumptions for NR DL is given in table below. Additional parameters corresponding to Eval Configurations are given in ANNEX K.

Parameter	Value		
Test environment	Indoor Hotspot – eMBB	Dense Urban – eMBB	Rural - eMBB
Evaluation configuration	Configuration A & B	Configuration A	Configuration A, B, C
Channel model	Channel A (Configuration A), Channel B (Configuration B)	Channel A	Channel A
ISD	20 m (36 TRxPs)	200 m	Configuration A, B: 1732 m Configuration C: 6000 m
TDD frame structure	DDDSU	DDDSU	DDDSU
Carrier Frequency	Configuration A: 4GHz Configuration B: 30GHz	Configuration A: 4GHz	Configuration A: 700 MHz Configuration B: 4 GHz Configuration C: 700 MHz
System bandwidth	Configuration A: 20 MHz; Configuration B: 80 MHz	Configuration A: 20MHz	TDD: 20MHz FDD: 10MHz
Subcarrier spacing	15kHz and 30kHz for configuration A 60kHz for configuration B	15kHz and 30kHz for configuration A	FDD: 15 kHz TDD: 30 kHz
Symbols number per slot	14	14	14
Number of antenna elements per TRxP	Configuration A/B: 32Tx cross-polarized antennas (M,N,P,Mg,Ng) = (4,4,2,1,1);	For 32Tx: 128Tx cross-polarized antennas (M,N,P,Mg,Ng) = (8,8,2,1,1) For 64Tx: 192Tx cross-polarized antennas	Configuration A/C: 64Tx cross-polarized antennas (M,N,P,Mg,Ng) = (8,4,2,1,1); Configuration B: 128Tx cross-polarized antennas

		(M,N,P,Mg,Ng) = (12,8,2,1,1)	(M,N,P,Mg,Ng) = (8,8,2,1,1)
Number of TXRU per TRxP	Configuration A/B: 32TXRU: Vertical 1-to-1	32TXRU: Vertical 2-to-8 64TXRU: Vertical 4-to-12	Configuration A/C: 8TXRU Vertical 1-to-8; 16TXRU Vertical 2-to-8. Configuration B: 32TXRU Vertical 2-to-8
Number of antenna elements per UE	Configuration A : 4Rx with 0°,90° polarization Configuration B : 8Rx with 0°,90° polarization (M,N,P,Mg,Ng; Mp,Np) = (2,4,2,1,2; 1,2)	4Rx with 0°,90° polarization	Configuration A: 2Rx Configuration B/C: 4Rx with 0°,90° polarization
Transmit power per TRxP	Configuration A: 24 dBm Configuration B: 23 dBm	44 dBm	TDD: 49 dBm FDD: 46 dBm
TRxP number per site	1	3	3
Mechanic tilt	180deg in GCS (pointing to the ground)	90deg in GCS (pointing to the horizontal direction)	90deg in GCS (pointing to the horizontal direction)
Electronic tilt	Configuration A: 90deg in LCS Configuration B: According to Zenith angle in "Beam set at TRxP"	105deg in LCS	Configuration A,B: 100deg in LCS Configuration C: 92deg in LCS
Beam set at TRxP	Configuration B: Azimuth angle $\phi_i = [0]$ , Zenith angle $\theta_j = [\pi/2]$	N/A	N/A
Beam set at UE	Configuration B: Azimuth angle $\phi_i = [-\pi/4, \pi/4]$ ; Zenith angle $\theta_j = [\pi/4, 3*\pi/4]$	N/A	N/A
UT attachment	Based on RSRP (Eq. (8.1-1) in TR 36.873) from port 0	Based on RSRP (Eq. (8.1-1) in TR 36.873) from port 0	Based on RSRP (Eq. (8.1-1) in TR 36.873) from port 0
Scheduling	MU-PF	MU-PF	MU-PF
ACK/NACK delay	Next available UL slot	Next available UL slot	Next available UL slot
MIMO mode	MU-MIMO with rank 2/4 adaptation per user; Configuration A: Maximum MU layer = 12;	MU-MIMO with rank 2/4 adaptation per user; Maximum MU layer = 12	MU-MIMO with rank 2/4 adaptation per user; Maximum MU layer = 8 for 8Tx and maximum



		Configuration B: Maximum MU layer = 6		MU layer = 12 for 16Tx and 32Tx;
Guard band ratio		Configuration A: 8.2% for 30kHz SCS and 4.6% for 15kHz SCS (for 20 MHz); Configuration B: 5.5% (for 80 MHz);	8.2% for 30kHz SCS and 4.6% for 15kHz SCS (for 20 MHz)	8.2% for 30kHz SCS and 4.6% for 15kHz SCS (for 20 MHz) FDD: 6.4% (for 10 MHz)
BS receiver type		MMSE-IRC	MMSE-IRC	MMSE-IRC
CSI feedback		5 slots period based on non-precoded CSI-RS with delay	For 32Tx: 5 slots period based on non-precoded CSI-RS with delay For 64Tx: 5 slots period based on precoded CSI-RS with delay	5 slots period based on non-precoded CSI-RS with delay
SRS transmission		Non-precoded SRS for 4Tx ports; Period: 5 slots; 2 symbols for 30kHz SCS; 4 symbols for 15kHz SCS;	Non-precoded SRS for 4Tx ports; Period: 5 slots; 2 symbols for 30kHz SCS; 4 symbols for 15kHz SCS;	Non-precoded SRS for 2/4 Tx ports for 2/4 Rx; Period: 5 slots; 4 symbols per 5 slots for configuration A/B for 15kHz and 30kHz; 2 symbols for 30kHz SCS and 4 symbols for 15kHz SCS for configuration C;
Precoder derivation		TDD: SRS based	TDD: SRS based	TDD: SRS based FDD: NR Type II codebook (4 beams, WB+SB quantization, 8 PSK)
Overhead	PDCCH	2 complete symbols	2 complete symbols	2 complete symbols
	DMRS	Type II, based on MU-layer	Type II, based on MU-layer	Type II, based on MU-layer
	CSI-RS	TDD: 32 ports per 5 slots	TDD: 32 ports per 5 slots	FDD: 8/16/32 ports for 8Tx/16Tx/32Tx TDD: 8/16/32 ports for 8Tx/16Tx/32Tx
	CSI-RS for IM	ZP CSI-RS with 5 slots period; 4 RE/PRB/5 slots	ZP CSI-RS with 5 slots period; 4 RE/PRB/5 slots	ZP CSI-RS with 5 slots period; 4 RE/PRB/5 slots
	SSB	1 SSB per 20 ms	1 SSB per 20 ms	1 SSB per 20 ms
	TRS	2 consecutive slots per 20 ms, 1 port, maximal 52 PRBs	2 consecutive slots per 20 ms, 1 port, maximal 52 PRBs	2 consecutive slots per 20 ms, 1 port, maximal 52 PRBs
	PTRS	Configuration B:	N/A	

		2 ports PT-RS, (L, K) = (1,4) L is time density and K is frequency density		N/A
Channel estimation		Non-ideal	Non-ideal	Non-ideal
Waveform		OFDM	OFDM	OFDM

### DL spectral efficiency evaluation for different system bandwidth in FR1 (Channel model A)

Test env.	Evaluation config.	Average spectral efficiency (bit/s/Hz/TRxP)				5 <sup>th</sup> percentile spectral efficiency (bit/s/Hz)			
		BW=20 MHz	BW=40 MHz	BW=100 MHz	Req.	BW=20 MHz	BW=40 MHz	BW=100 MHz	Req.
Indoor Hotspot	Config. A (15KHz SCS); 32T4R	12.536	-	-	9	0.387	-	-	0.3
	Config. A (30KHz SCS); 32T4R	12.725	14.888	16.368		0.37	0.433	0.476	
Dense Urban	Config. A (30KHz SCS); 32T4R	12.8	14.904	16.346	7.8	0.375	0.437	0.479	0.225
	Config. A (30KHz SCS); 64T4R	15.8	18.489	20.328		0.485	0.568	0.624	
Rural	Config. A 8T2R <sup>8</sup>	6.594	7.383	7.927	3.3	0.138	0.155	0.166	0.12
	Config. B (30KHz SCS); 32T4R	15.061	17.54	19.238		0.374	0.436	0.478	
	Config. C 8T4R	7.597	8.51	9.138		0.18	0.202	0.217	

### TDD DL spectral efficiency evaluation for FR2 (Channel model B)

Test env.	Evaluation config.	Average spectral efficiency (bit/s/Hz/TRxP)	5 <sup>th</sup> percentile spectral efficiency (bit/s/Hz)
-----------	--------------------	---	---

<sup>8</sup> For FDD systems, the Bandwidth used is 10,20,50 MHz respectively.

		BW=80 MHz	BW=100 MHz	BW=200 MHz	Req.	BW=80 MHz	BW=100 MHz	BW=200 MHz	Req.
Indoor Hotspot	Config. B (60KHz SCS); 32T8R	11.384	11.984	12.998	9	0.302	0.318	0.345	0.3

### Uplink SE

Evaluation Assumptions for NR UL is given in table below. Additional parameters corresponding to Eval Configurations are given in ANNEX K.

Parameter	Value		
Test environment	Indoor Hotspot – eMBB	Dense Urban – eMBB	Rural - eMBB
Evaluation configuration	Configuration A,B	Configuration A	Configuration A,B,C
Channel model	Channel A(Configuration A),Channel B(Configuration B)	Channel A	Channel A
Subcarrier spacing	TDD: 15kHz and 30kHz for configuration A, 60kHz for configuration B	TDD: 15kHz and 30kHz	Configuration A,B: 1732 m Configuration C: 6000 m
TDD frame structure	DDDSU	DDDSU	DDDSU
Symbols number per slot	14	14	14
Number of antenna elements per TRxP	Configuration A: 32Rx cross-polarized antenna (M,N,P,Mg,Ng) = (4,4,2,1,1); Configuration B: 64Rx cross-polarized antenna for 16TXRU, (M,N,P,Mg,Ng) = (4,8,2,1,1); 32Rx cross-polarized antenna for 32TXRU, (M,N,P,Mg,Ng) = (4,4,2,1,1);	For 32Rx: 128Rx cross-polarized antenna (M,N,P,Mg,Ng) = (8,8,2,1,1) For 64Rx: 192Rx cross-polarized antenna (M,N,P,Mg,Ng) = (12,8,2,1,1)	Configuration A,C: 64Rx cross-polarized antenna (M,N,P,Mg,Ng) = (8,4,2,1,1); Configuration B: 128Rx cross-polarized antenna (M,N,P,Mg,Ng) = (8,8,2,1,1)
Number of TXRU per TRxP	Configuration A/B: 32TXRU Vertical 1-to-1; Configuration B: 16TXRU Vertical 2-to-4, Horizontal 4-to-8	32TXRU: Vertical 2-to-8 64TXRU: Vertical 4-to-12	Configuration A,C: 8TXRU Vertical 1-to-8 Configuration B: 32TXRU Vertical 2-to-8

Number of antenna elements per UE	Configuration A : 2Tx/4Tx with 0°,90° polarization Configuration B : 8Tx with 0°,90° polarization (M,N,P,Mg,Ng; Mp,Np) = (2,4,2,1,2; 1,2)	2Tx/4Tx with 0°,90° polarization	Configuration A: 1Tx for FDD, 2Tx with 0°,90° polarization ; Configuration B: 1Tx/4Tx with 0°,90° polarization Configuration C: 2Tx/4Tx with 0°,90° polarization
UE power class	23 dBm	23 dBm	23 dBm
Mechanic tilt	180deg in GCS (pointing to the ground)	90deg in GCS (pointing to the horizontal direction)	90deg in GCS (pointing to the horizontal direction)
Electronic tilt	Configuration A: 90deg in LCS Configuration B: According to Zenith angle in "Beam set at TRxP"	105deg in LCS	Configuration A/B: 100deg in LCS Configuration C: 92deg in LCS
Beam set at TRxP	Configuration B: For 32Rx, Azimuth angle $\phi_i = [0]$ , Zenith angle $\theta_j = [\pi/2]$ ; For 16Rx, Azimuth angle $\phi_i = [-\pi/4, \pi/4]$ , Zenith angle $\theta_j = [\pi/2]$ ;	N/A	N/A
Beam set at UE	Configuration B: Azimuth angle $\phi_i = [-\pi/4, \pi/4]$ ; Zenith angle $\theta_j = [\pi/4, 3*\pi/4]$	N/A	N/A
UT attachment	Based on RSRP (Eq. (8.1-1) in TR36.873) from port 0	Based on RSRP (Eq. (8.1-1) in TR36.873) from port 0	Based on RSRP (Eq. (8.1-1) in TR36.873) from port 0
Scheduling	SU-PF	SU-PF	SU-PF
MIMO mode	Configuration A: SU-MIMO with rank 2 adaptation; Configuration B: SU-MIMO with rank 4 adaptation;	SU-MIMO with rank 2 adaptation	SIMO for 1Tx; SU-MIMO with rank 2 adaptation for 2Tx/4Tx
BS receiver type	MMSE-IRC	MMSE-IRC	MMSE-IRC
UE precoder scheme	Codebook based	Codebook based	Codebook based
UL CSI derivation	Non-precoded SRS based, with delay	Non-precoded SRS based, with delay	Non-precoded SRS based, with delay
Power control	$\alpha = 0.9, P_0 = -86$ dBm	$\alpha = 0.6, P_0 = -60$ dBm	Configuration A: $\alpha = 0.8, P_0 = -76$ dBm; Configuration B: $\alpha = 0.6, P_0 = -60$ dBm; Configuration C: $\alpha = 0.6, P_0 = -60$ dBm
Power model backoff	Continuous RB allocation: follow TS 38.101 in Section 6.2.2; Non-continuous RB allocation: additional 2 dB reduction	Continuous RB allocation: follow TS 38.101 in Section 6.2.2; Non-continuous RB allocation: additional 2 dB reduction	Continuous RB allocation: follow TS 38.101 in Section 6.2.2; Non-continuous RB allocation: additional 2 dB reduction

Overhead	PUCCH	2 RBs and 14 OFDM symbols for TDD 30kHz SCS; 4 RBs and 14 OFDM symbols for TDD 15kHz SCS;	2 RBs and 14 OFDM symbols for TDD 30kHz SCS; 4 RBs and 14 OFDM symbols for TDD 15kHz SCS;	2 RBs and 14 OFDM symbols for FDD and TDD 30kHz SCS; 4 RBs and 14 OFDM symbols for TDD 15kHz SCS;
	DMRS	Type II, 2 symbols (including one additional DMRS symbol), multiplexing with PUSCH	Type II, 2 symbols (including one additional DMRS symbol), multiplexing with PUSCH	Type II, 2 symbols (including one additional DMRS symbol), multiplexing with PUSCH
	SRS	2 symbols per 5 slots,	2 symbols per 5 slots,	2 symbols per 5 slots,
	PTRS	N/A	N/A	N/A
Channel estimation	Non-ideal		Non-ideal	Non-ideal
Waveform	OFDM		OFDM	OFDM

### UL spectral efficiency evaluation in FR1 (Channel model A)

Test env.	Evaluation Config.	Average spectral efficiency (bit/s/Hz/TRxP)				5 <sup>th</sup> percentile spectral efficiency (bit/s/Hz)			
		BW=20 MHz	BW=40 MHz	BW=100 MHz	Req.	BW=20 MHz	BW=40 MHz	BW=100 MHz	Req.
Indoor Hotspot	Config. A (15KHz SCS); 2T32R	7.545	-	-	6.75	0.419	-	-	0.21
	Config. A (15KHz SCS); 4T32R	8.279	-	-		0.459	-	-	
	Config. A (30KHz SCS); 2T32R	7.551	7.847	8.401		0.42	-	-	
	Config. A (30KHz SCS); 4T32R	8.234	-	-		0.471	0.436	0.467	
Dense Urban	Config. A (30KHz SCS); 2T32R	6.662	6.923	7.412	5.4	0.3	0.312	0.334	0.15
	Config. A (30KHz SCS); 2T64R	7.633	7.932	8.492		0.386	0.401	0.429	
Rural	Config. A 1T8R	4.17	4.250	4.414	1.6	0.134	0.137	0.142	0.045
	Config. B (30KHz SCS); 1T32R	3.457	3.593	3.846		0.123	0.128	0.137	

Config. 2T8R	C	4.038	4.116	4.274		0.081	0.083	0.086	
--------------	---	-------	-------	-------	--	-------	-------	-------	--

### UL spectral efficiency evaluation for FR2 (Channel model B)

Test env.	Evaluation config.	Average spectral efficiency (bit/s/Hz/TRxP)				5 <sup>th</sup> percentile spectral efficiency (bit/s/Hz)			
		BW=80 MHz	BW=100 MHz	BW=200 MHz	Req.	BW=20 MHz	BW=100 MHz	BW=200 MHz	Req.
Indoor Hotspot	Config. B (30KHz SCS); 8T32R	7.392	7.434	7.477	6.75	0.425	0.427	0.43	0.21
	Config. B (60KHz SCS); 8T16R	6.382	6.418	6.455		0.245	0.246	0.248	

### Evaluation Report

Minimum technical performance requirements item	Category	Required value	Value (BW:20MHz(TDD) & 10 MHz(FDD))		Requirement met?
			FR1(channel A)	FR2(channel B)	
Average spectral efficiency (bit/s/Hz)	Indoor Hotspot – eMBB FR1-Configuration A FR2-Configuration B	DL: 9	12.725	11.384	Yes
		UL: 6.75	7.551	7.392	
	Dense Urban – eMBB FR1-Configuration A	DL: 7.8	12.8		Yes
		UL: 5.4	6.662		
Rural – eMBB Configuration A,B,C	DL:3.3	6.594,15.061,7.597		Yes	
	UL:1.6	4.17,3.457,4.038			
5 <sup>th</sup> Percentile User Spectral Efficiency (bits/s/Hz)	Indoor Hotspot – eMBB FR1-Configuration A FR2-Configuration B	DL: 0.3	0.37	0.302	Yes
		UL: 0.21	0.42	0.425	
	Dense Urban – eMBB FR1-Configuration A	DL: 0.225	0.375		Yes
		UL: 0.15	0.3		
	Rural – eMBB FR1-Configuration A,B,C	DL:0.12	0.138,0.374,0.18		Yes
		UL:0.045	0.134,0.123,0.08		

### 2.2.3.1-B SPECTRAL EFFICIENCY - SUPPLEMENTARY EVALUATION

#### A. Cellular technology serving fixed line use cases

While the primary application of the 3GPP NR technology will be for mobile broadband connectivity, one of the initial use cases is aimed at addressing fixed line like wireless services. Fixed Wireless Access (FWA) enables service providers to deliver high-speed broadband to suburban and rural areas where fiber is prohibitively expensive to lay and maintain. This employs standardized 3GPP architectures and common mobile components to deliver ultra-high-speed broadband services to residential subscribers and enterprise customers. The 5G NR supplier ecosystem is already large and growing continually, with the addition of standardized User Equipment (UE), merchant silicon and mobile networking equipment that can be reused for FWA with no modification. For developing nations like India, this offers a faster means to offer broadband connectivity.

Initial Fixed Wireless Access trials using 5G New Radio employ a classic Evolved Packet Core (EPC) infrastructure for data transport and control information. Commonly referred to as Option 3x, the new gNodeB's (gNB's) supporting FWA and other early 5G deployments operate in a Non-Standalone (NSA) manner alongside the existing 4G eNodeB. Option 3 reduces deployment risks and variables when first implementing 5G FWA.

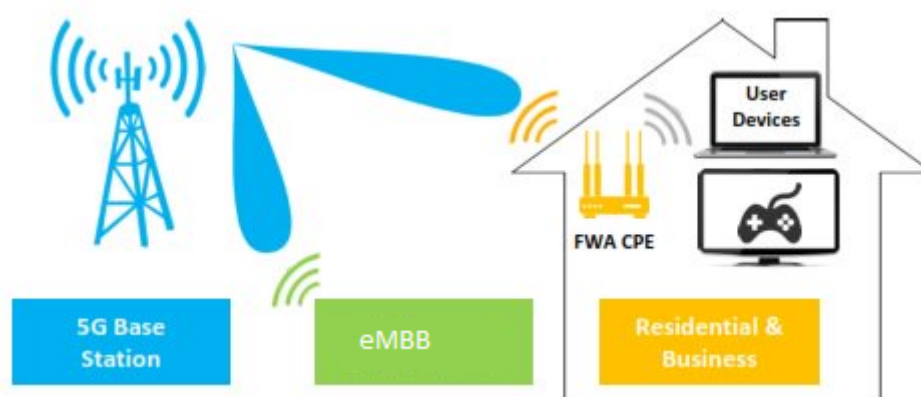

Figure 2.3 3GPP gNodeB used for FWA applications

5G FWA in the lower bands of the wireless spectrum can be used to quickly and cheaply deliver an alternative to wired broadband. In the millimeter wavelengths (mmWave), 5G FWA can provide a level of service bandwidth capacity comparable to fiber optics. With NR in the mmWave, 5G FWA can provide a competitive alternative to fixed-line DSL, Cable and fiber across all markets. They offer

narrow beams to enable a higher density of users without causing interference. This provides a means by which suburban and rural consumers can receive the bandwidth required to support high definition streaming services and high-speed Internet access, thereby addressing the last mile need. This provides a larger opportunity for developing countries that are lacking in broadband penetration, while also addressing slow speed DSL lines in developed nations.

It is worth noting that IMT2020 key performance indicators (KPI) are aimed at wireless use cases. The KPI's of wireline systems differ significantly from wireless systems. While the wireless systems target spectral efficiency values, the fixed line systems target fixed speed or fixed data rates. For an FWA to target such use cases, this places undue burden on the wireless scheduler to service. Too little is available in literature studying such behaviors. During the IMT-Advanced standardization phase, WP5D received the performance comparison using a wireless DSL (WDSL<sup>9</sup>) scheduler attributed to TCoE India. It employed a very simple hack to the proportionally fair (PF) scheduler, with the fairness exponent ( $\beta$ ) changed to 5 from 1. While there are no follow-up studies on why this need to be a means for comparison, this approach provides limited insight on how the wireless system behaves with constraints on the scheduling on the same IMT evaluation framework. Refer the figure below for a comparison with different fairness coefficients ( $\beta$ ).

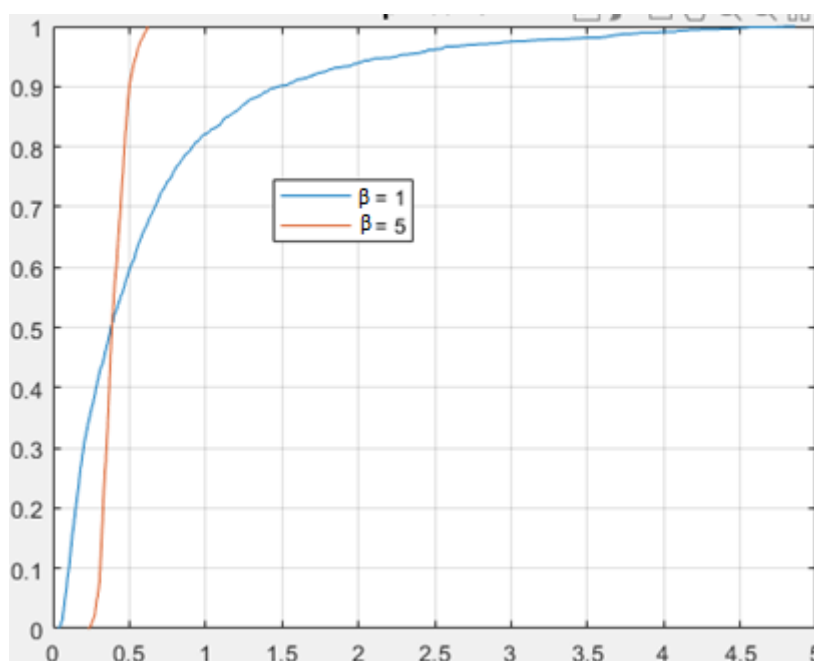

Figure 2.4 Throughput comparison of PF and WDSL

### Scheduler Description

In this section, we offer a brief description of the scheduler for the interested reader to catch up with our description. The scheduling algorithm employed in the MAC functions as follows:

- i. The gNodeB obtains the feedback of the instantaneous channel quality condition (CQI) for each UE  $k$  in time slot  $t$  in terms of a requested data rate  $R_{k,n}(t)$  on every physical resource block (PRB)  $n$
- ii. The gNodeB also keeps track of the moving average throughput  $T_{k,n}(t)$  for UE  $k$

<sup>9</sup> [Doc. IMT-ADV/16-](#) Evaluation of IMT-Advanced candidate technology submissions in Documents IMT-ADV/4 and IMT-ADV/8 by TCoE India



- iii. The scheduling mechanism gives a priority to the UE  $k^*$  in the  $t^{\text{th}}$  time slot and PRB  $n$  that satisfy the maximum relative channel quality condition:

$$k^* = \arg \max_{k=1,2,\dots,K} \frac{[R_{k,n}(t)]^\alpha}{[T_{k,n}(t)]^\beta}$$

- iv. The choice of values for  $\alpha$  and  $\beta$  decide the nature of the scheduler
  - a.  $\alpha = 1$  and  $\beta = 0$ , represents a max-rate scheduler
  - b.  $\alpha = 0$  and  $\beta = 1$ , represents a round-robin scheduler
  - c.  $\alpha = 1$  and  $\beta = 1$ , represents a proportionally fair scheduler
- v. For the WDSL scheduler, we employ  $\alpha = 1$  and  $\beta = 5$ .
- vi. The gNodeB updates  $T_{k,n}(t)$  of the  $k^{\text{th}}$  UE in the  $t^{\text{th}}$  time slot using the exponential moving average filter given by:

$$T_{k,n}(t+1) = \begin{cases} \left(1 - \frac{1}{t_c}\right) T_{k,n}(t) + \frac{1}{t_c} R_{k,n}(t), & k^* = k \\ \left(1 - \frac{1}{t_c}\right) T_{k,n}(t) \dots\dots\dots, & k^* \neq k \end{cases}$$

- vii. The scheduling algorithms treat the individual PRB's to be scheduled independently, and then update the system every time slot.

While the PF scheduler strives for a balance between fairness and overall system throughput, the WDSL scheduler strives to provide a minimum rate guarantee to the users admitted into the system.

### Performance Comparison

The simulation setup follows the rural config C scenario in Sec. 2.2.3.1. The only tweak to the analysis is in rerunning the simulation with the new value for  $\beta$  for the PF scheduler. The cell capacity with different values of  $\beta$  is listed below.

	PF ( $\beta = 1$ )	WDSL ( $\beta = 5$ )
Cell capacity (Mbps) 700 Mhz, with 20 MHz in rural config C.	151.94	84.31

If the simulation were a real deployment scenario, then with the WDSL scheduler about 8 Mbps data rate per user can be guaranteed per user. However, from the operator perspective, it only achieved about half of the call capacity. There are more studies to be undertaken on such use cases, and this proved a positive start for 5GIF / COAI in that direction<sup>7</sup>.

### B. Uplink Performance with High Power UE

Higher frequency signals can't travel far, so cellular carriers like Sprint worked within 3GPP on means to achieve higher output power, specifically in the uplink (uplink defines the cell range). Devices supporting a new power class, Power Class 2 (PC2) were the consequence. PC2 was originally developed to develop high-performance user equipment (HPUE) and improve the 2.5 GHz LTE TDD coverage. With 3GPP NR standardization, this functionality is been extended to several more frequency bands in Rel-15 specifications. PC2 allows for output power levels of 26 dBm or double the maximum output power previously defined by PC3 (23 dBm). The increase in output power to PC2 compensates for greater propagation losses at the higher TDD frequencies, enabling carriers to maintain cell coverage without adding expensive infrastructure.

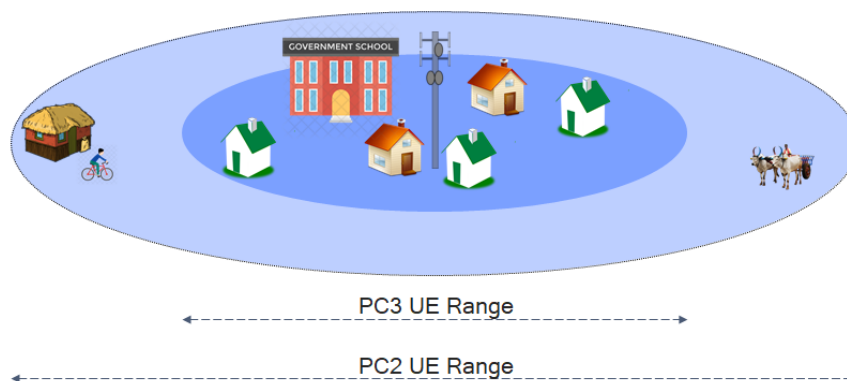

Figure 2.5 Extended coverage of PC2 devices over PC3

PC2 devices could be implemented using the same architecture as PC3 UEs, but with modified PA (Power Amplifiers) and filters. Such devices help improve the cell-edge spectral efficiency by using higher order modulation and transport block size, due to additional power headroom available with the higher uplink transmit power (refer Fig. below). It can also help enhance the overall cell-edge performance, especially where the downlink performance is limited by the speed of acknowledgements in uplink. Considering that a certain link imbalance will remain during 5G Non-standalone (NSA) deployments, PC2 for Dual Connectivity UE (one LTE band + one NR band) should be the most practical and suitable choice to improve the uplink coverage for 5G NR NSA deployment. With extended coverage, the Out of Service (OoS) and Radio Link Failures (RLF) improve significantly with HPUE when compared to the legacy devices.

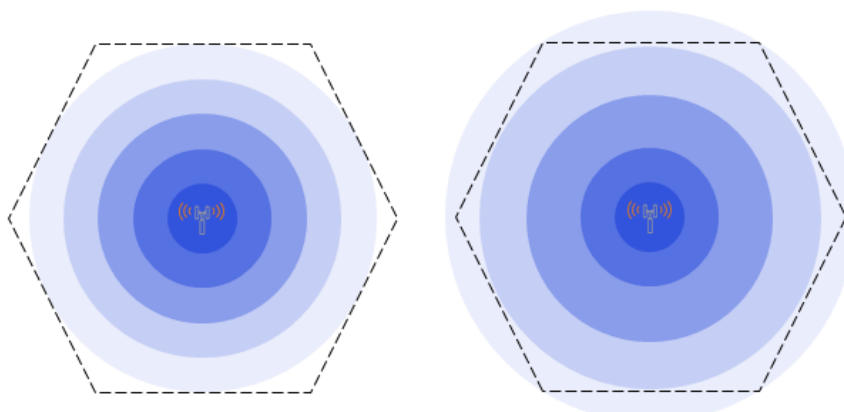

Fig: A typical cell coverage using PC3 and PC2 devices

### Scheduler Description

To understand the value proposition of HPUE to devices, we device a simple modification to the existing IMT-2020 rural-LMLC test scenario. We assume that the UE's are capable of PC2 and allow the UE's reporting below a certain MCS value to employ PC2 (refer the Figure 2.6).

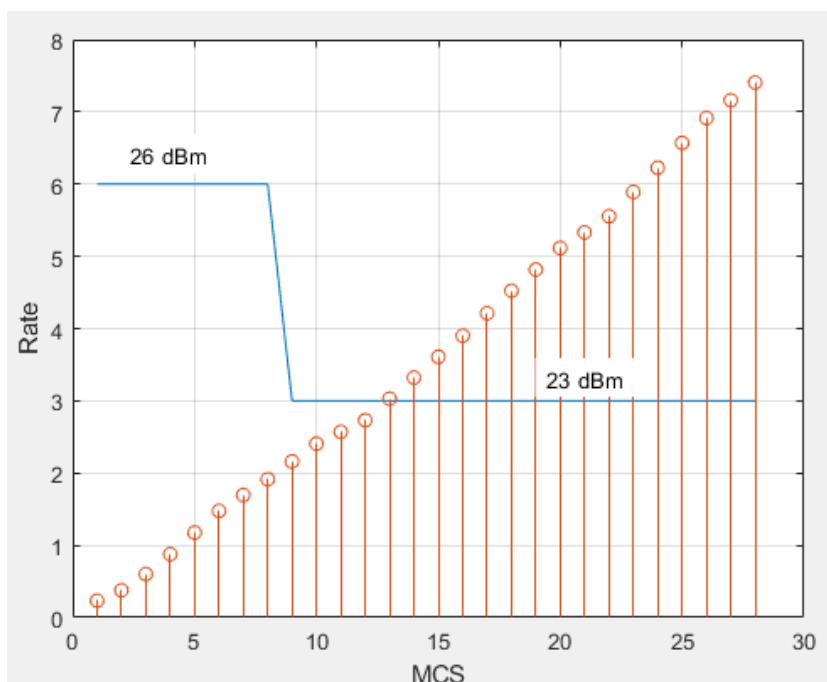

Figure 2.6 UE's reporting below MCS8 employing PC2 mode

### Performance comparison

The simulation setup follows the same rural config C scenario in Sec. 2.2.3.1-A. The only tweak to the analysis is in rerunning the simulation with the link adaptation, where UE's reporting below a certain MCS index were changed from PC3 (W/O HPUE) capability to PC2 (With HPUE). The CDF of spectral efficiency values seen under these scenarios is plotted below for reference.

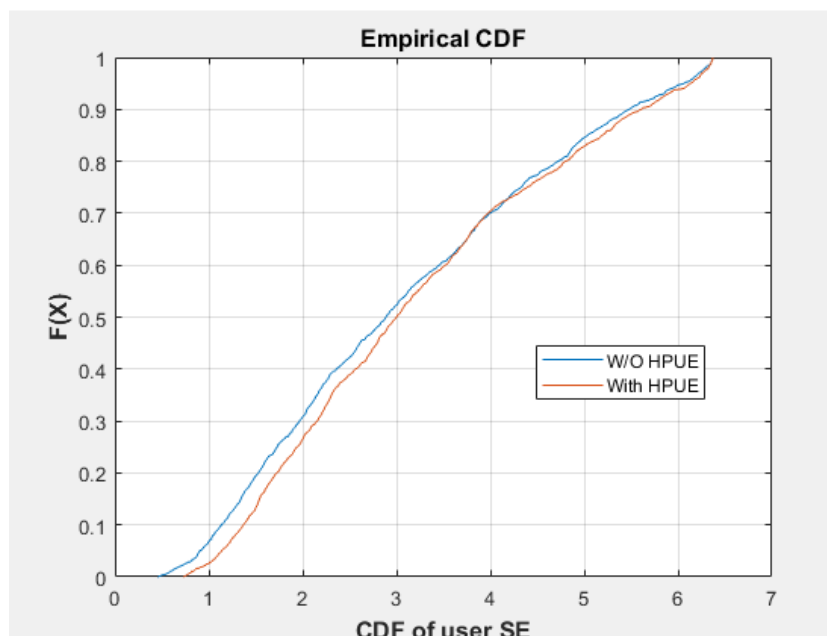

Figure 2.7 CDF of User SE with and without HPUE

It can be inferred from the plots that the SE of those UE's with very low values increase, whereas those with higher rates did not change by much. This is one move in the right direction by 3GPP whereby the operators now have a chance to deploy PC2 (HPUE) devices in their network to improve cell edge or outage issues, without focusing on the need for additional infra. The 5GIF / COAI is prepared to carry additional studies on the usefulness of this feature to meet NDCP targets<sup>7</sup>.

### 2.2.3.2 CONNECTION DENSITY

Connection density is the total number of devices fulfilling a specific quality of service (QoS) per unit area (per km<sup>2</sup>). Connection density should be achieved for a limited bandwidth and number of TRxP's. The target QoS is to support delivery of a message of a certain size within a certain time and with a certain success probability, as specified in Report ITU-R M.2412-0.

As explained earlier, the evaluation by 5GIF IEG focused on the NR and NB-IoT. And with NB-IoT replacing the mMTC candidate in IMT-2020/14, we get the candidate submission from China (IMT-2020/15). It therefore serves the dual purpose of having a technology of interest for the 5GIF assessed, and fulfilling for the complete evaluation of another candidate IMT-2020 technology.

#### Requirements

This requirement is defined for the purpose of evaluation in the mMTC usage scenario. The minimum requirement for connection density is 1 000 000 devices per km<sup>2</sup>.

NB-IoT (LTE) and 3GPP NR have evaluated for Connection Density requirements.

#### Evaluation Methodology

According to Report ITU-R M.2412, connection density is said to be  $C$  (# of devices per km<sup>2</sup>), if, under the number of devices,  $N=C \times A$  ( $A$  is the simulation area in terms of km<sup>2</sup>), that the packet outage rate is less than or equal to 1%, where the packet outage rate is defined as the ratio of

- The number of packets that failed to be delivered to the destination receiver within a *transmission delay* of less than or equal to 10s

to

- The total number of packets generated by the ( $N=C \times A$ ) devices within the time  $T$ .

The transmission delay of a packet is understood to be the delay from the time when uplink packet arrives at the device to the time when the packet is correctly received at the destination (BS) receiver.

In addition, it is encouraged that the self-evaluation reports the connection efficiency which is given by

$$CE = \frac{C \cdot A}{M \cdot W} \text{ (# of device/Hz/TRxP)} \quad (1)$$

where  $C$  is the connection density (# of devices per km<sup>2</sup>),  $A$  is the simulation area in terms of km<sup>2</sup>,  $M$  is the number of TRxP in the simulation area  $A$ , and  $W$  is the UL bandwidth (for FDD).

In Report ITU-R M.2412, There are two possible evaluation methods to evaluate connection density requirement defined in ITU-R M.2410-0:

- non-full buffer system-level simulation;
- full-buffer system-level simulation followed by link-level simulation.

#### System simulation procedure

There are two system simulation procedures for evaluating connection density. The first is a non-full buffer system-level simulation that requires a state-of-the-art system simulator to perform the evaluations. The second is a full buffer system simulation that allows input based on a more rudimentary system simulator combined with post processing supported by link-level simulations. The full buffer approach is described in detail in Table 2-16, and the non-full buffer is described in Table 2-17

*Table 2-16 Full buffer system-level simulation procedure*

<b>Full buffer system-level simulation</b>	
<i>Step 1:</i>	<p>Perform full-buffer system-level simulation using the evaluation parameters for Urban Macro-mMTC test environment, determine the uplink <math>SINR_i</math> for each percentile <math>i=1\dots99</math> of the distribution over users, and record the average allocated user bandwidth <math>W_{user}</math>.</p> <p>In case UE multiplexing on the same time/frequency resource is modelled in this step, record the average number of multiplexed users <math>N_{mux}</math>. <math>N_{mux} = 1</math> for no UE multiplexing.</p>
<i>Step 2:</i>	<p>Perform link-level simulation and determine the achievable user data rate <math>R_i</math> for the recorded <math>SINR_i</math> and <math>W_{user}</math> values.</p> <p>In case UE multiplexing on the same time/frequency resource is modelled in this step, record the average number of multiplexed users <math>n_{mux,i}</math> under <math>SINR_i</math>. The achievable data rate for this case is derived by <math>R_i = Z_i/n_{mux,i}</math>, where aggregated bit rate <math>Z_i</math> is the summed bit rate of <math>n_{mux,i}</math> users on <math>W_{user}</math>. <math>n_{mux,i} = 1</math> for no UE multiplexing.</p>
<i>Step 3:</i>	<p>Calculate the packet transmission delay of a user as <math>D_i = S/R_i</math>, where <math>S</math> is the packet size.</p>
<i>Step 4:</i>	<p>Calculate the traffic generated per user as <math>T = S/T_{inter-arrival}</math>, where <math>T_{inter-arrival}</math> is the inter-packet arrival time.</p>
<i>Step 5:</i>	<p>Calculate the long-term frequency resource requested under <math>SINR_i</math> as <math>B_i = T/(R_i/W_{user})</math>.</p>
<i>Step 6:</i>	<p>Calculate the number of supported connections per TRxP, <math>N = W / \text{mean}(B_i)</math>. <math>W</math> is the simulation bandwidth. The mean of <math>B_i</math> may be taken over the best 99% of the <math>SINR_i</math> conditions.</p> <p>In case UE multiplexing is modelled in Step 1, <math>N = N_{mux} \times W / \text{mean}(B_i)</math>. In case UE multiplexing is modelled in Step 2, <math>N = W / \text{mean}(B_i/n_{mux,i})</math>.</p>
<i>Step 7:</i>	<p>Calculate the connection density as <math>C = N / A</math>, where the TRxP area <math>A</math> is calculated as <math>A = \text{ISD}^2 \times \text{sqrt}(3)/6</math>, and ISD is the inter-site distance.</p>
<i>Misc:</i>	<p>The requirement is fulfilled if the 99<sup>th</sup> percentile of the delay per user <math>D_i</math> is less than or equal to 10s, and the connection density is greater than or equal to the connection density requirement defined in ITU-R M.[IMT-2020.TECH PERF REQ].</p> <p>The simulation bandwidth used to fulfill the requirement should be reported. Additionally, it is encouraged to report the connection efficiency (measured as <math>N</math> divided by simulation bandwidth) for the achieved connection density.</p>

Table 2-17 Non-full buffer system-level simulation procedure

<b>Non-full buffer system-level simulation</b>	
<i>Step 1:</i>	Set system user number per TRxP as $N$ .
<i>Step 2:</i>	Generate the user packet according to the traffic model.
<i>Step 3:</i>	Run non-full buffer system-level simulation to obtain the packet outage rate. The outage rate is defined as the ratio of the number of packets that failed to be delivered to the destination receiver within a transmission delay of less than or equal to 10s to the total number of packets generated in the step 2.
<i>Step 4:</i>	Change the value of $N$ and repeat step2-3 to obtain the system user number per TRxP $N'$ satisfying the packet outage rate of 1%.
<i>Step 5:</i>	Calculate connection density by equation $C = N' / A$ , where the TRxP area $A$ is calculated as $A = \text{ISD}^2 \times \text{sqrt}(3)/6$ , and ISD is the inter-site distance.
<i>Misc:</i>	The requirement is fulfilled if the connection density $C$ is greater than or equal to the connection density requirement defined in ITU-R M.[IMT-2020.TECH PERF REQ]. The simulation bandwidth used to fulfill the requirement should be reported. Additionally, it is encouraged to report the connection efficiency (measured as $N'$ divided by simulation bandwidth) for the achieved connection density.

## Results

### Non-full buffer system level simulation

NB-IoT are evaluated using non-full buffer system level simulation as defined in Report ITU-R M.2412, following the model as described in Annex A and Annex B. The detailed simulation assumption is shown in Annex C. The evaluation results are given in Table 2-18 and Table 2-19, respectively.

Table 2-18 Evaluation results for NB-IoT for ISD=1732m

		Config B (ISD = 1732m), channel mode A	Config B (ISD = 1732m), channel mode B
<i>NB-IoT</i>	Devices supported per km <sup>2</sup> per 180kHz	599,000	601,940
	Required bandwidth to support 1,000,000 devices	360kHz	360kHz
	Connection efficiency (#of devices/Hz/TRxP)	2.88	2.896

Table 2-19 Evaluation results for NB-IoT for ISD=500m

		Config A (ISD = 500m), channel mode A	Config A (ISD = 500m), channel mode B

NB-IoT	Devices supported per km <sup>2</sup> per 180kHz	8,047,087	8,077,017
	Required bandwidth to support 1,000,000 devices	180kHz	180kHz
	Connection efficiency (#of devices/Hz/TRxP)	3.226	

### Full buffer system-level simulation followed by link-level simulation

The connection density of NB-IoT and NR are evaluated using full buffer system level simulation with link level simulation as defined in Report ITU-R M.2412. The evaluation results are provided in Table 2-20. The UL SINR distribution of full buffer simulation is shown in Annex E and the link level spectrum efficiency of NB-IoT and NR is shown in Annex F.

The 99% latency derived by SINR could fulfill the 10s latency requirement.

*Table 2-20 Evaluation result of full buffer system-level followed by link-level simulation*

		Config A (ISD=500m) Channel mode A	Config A (ISD=500m) Channel mode B	Config B (ISD=1732m) Channel mode A	Config B (ISD=1732m) Channel mode B
NB-IoT	Devices supported per km <sup>2</sup> per 180kHz	43,271,000	43,846,000	2,567,000	2,702,000
	Connection efficiency (#of devices/Hz/TRx P)	17.348	17.579	12.35	13.0
NR	Devices supported per km <sup>2</sup> per 180kHz	36,574,000	35,021,000	1,138,000	1,465,000
	Connection efficiency (#of devices/Hz/TRx P)	14.663	14.041	5.475	7.048

The evaluation result of full buffer system-level simulation followed by link-level simulation is quite higher than non-full buffer system-level simulation since it has an ideal assumption of resource scheduling and the delays due to access procedure is not taken into account. In addition, the DL resource allocation is not considered in this evaluation method, while in practice DL resource allocation may be the bottleneck of the access procedure, which will introduce large delay, and result in packet drop. In this sense, the evaluation method of full buffer system-level simulation with link level simulation demonstrates a best case result for the candidate technology.

It is observed that NB-IoT has the advantage of higher UL SINR due to higher power spectral density, which is the result of its finer frequency granularity on data allocation. It in turns results in higher spectrum efficiency from system view. In summary, the evaluation results show that NB-IoT and NR could fulfill the IMT-2020 requirement.

### **Evaluation Report**

Minimum technical performance requirements item	Category	Required value	Value	Requirement met?	Comment
Average spectral efficiency (bit/s/Hz)	NB-IoT	1,000,000 devices per km <sup>2</sup>	2,567,000-43,846,000	Yes	180 kHz
	NR		1,138,000-36,574,000	Yes	180 kHz

#### 5GIF Observation

- i. NB-IoT (technology component of IMT-2020/13) can fulfil the IMT-2020 mMTC requirement under non-full buffer system level simulation, and NB-IoT demonstrates higher connection efficiency, with only 180 kHz carrier. It is worth noting that the technology component is already part of an earlier release from 3GPP (Rel-15)
- ii. NB-IoT and NR can fulfil IMT-2020 requirement under full buffer system-level simulation followed by link-level simulation, and NB-IoT demonstrates higher connection efficiency.



### 2.2.3.3 MOBILITY

#### Requirements

Mobility is the maximum mobile station speed at which a defined QoS can be achieved (in km/h). The following classes of mobility are defined:

- Stationary: 0 km/h
- Pedestrian: 0 km/h to 10 km/h
- Vehicular: 10 km/h to 120 km/h
- High speed vehicular: 120 km/h to 500 km/h.

High speed vehicular up to 500 km/h is mainly envisioned for high speed trains. Table 2-21 defines the mobility classes that shall be supported in the respective test environments.

*Table 2-21 Mobility classes*

	Test environments for eMBB		
	Indoor Hotspot – eMBB	Dense Urban – eMBB	Rural – eMBB
Mobility classes supported	Stationary, Pedestrian	Stationary, Pedestrian, Vehicular (up to 30 km/h)	Pedestrian, Vehicular, High speed vehicular

A mobility class is supported if the traffic channel link data rate on the uplink, normalized by bandwidth, is as shown in Table 2-22. This assumes the user is moving at the maximum speed in that mobility class in each of the test environments. This requirement is defined for the purpose of evaluation in the eMBB usage scenario.

*Table 2-22 Traffic channel link data rates normalized by bandwidth*

Test environment	Normalized traffic channel link data rate (Bit/s/Hz)	Mobility (km/h)
Indoor Hotspot – eMBB (InH-eMBB)	1.5	10
Dense Urban – eMBB (DU-eMBB)	1.12	30
Rural – eMBB (RU-eMBB)	0.8	120
	0.45	500

#### Evaluation Methodology

The following steps have been followed in order to evaluate the mobility requirement.

*Step 1:*

Run uplink system-level simulations, identical to those for average spectral efficiency, and 5<sup>th</sup> percentile user spectral efficiency.

- a. Using link-level simulations and a link-to-system interface [SINR to BLER curve as in SE case] appropriate for these speed values [Speed values to be included in SLS] [ as per M.2412 channel models], for the set of selected test environment(s) associated 120 and 500kmph.
- b. Collect overall statistics for uplink SINR values
- c. Construct CDF over these values for each test environment.

*Step 2:*

Use the CDF for the test environment(s) to save the respective 50<sup>th</sup>-percentile *SINR* value. Before Rx detection/demodulation *SINR*. i.e. @3GPP RAN1 pre-*SINR*( refer Section on Pre-Processing *SINR*)

*Step 3:*

Run new uplink link-level simulations for the selected test environment(s) for either NLOS or LOS channel conditions using the associated speeds in Table 4 of Report ITU-R M.2410-0, as input parameters, [in Link level simulation incorporate Doppler freq. shift due to mobility – single user]

- a. obtain link data rate and residual packet error ratio as a function of *SINR*.

(The link-level simulation shall use air interface configuration(s) supported by the proposal and take into account retransmission, channel estimation and phase noise impact)

*Step 4:*

Compare the uplink spectral efficiency values (link data rate normalized by channel bandwidth) obtained from *Step 3* using the associated *SINR* value obtained from *Step 2* for selected test environments, with the corresponding threshold values in the Table 4 of Report ITU-R M.2410-0.

*Step 5:*

The proposal fulfils the mobility requirement if the spectral efficiency value is larger than or equal to the corresponding threshold value and if also the residual decoded packet error ratio is less than 1%, for all selected test environments. For the selected test environment, it is sufficient if one of the spectral efficiency values (using either NLOS or LOS channel conditions) fulfils the threshold.

Mean Value of ZoD Spread for LOS and NLOS

In link level simulation, LOS and NLOS channel are to be evaluated separately. Therefore, the mean value of ZoD spread should be derived for LOS and NLOS, separately. Based on the above, the detailed derivation is as follows:

- In the UE drop in system level simulation, determine LOS UE and NLOS UE according to LOS probability from system level channel model (LOS UE means the channel state is LOS for UE to its serving TRxP; NLOS UE means the channel state is NLOS for UE to its serving TRxP)
- Assume there are N LOS UEs, and M NLOS UEs; (N+M=570) for dense urban and rural test environment. Calculate the value of lgZSD for LOS UE and NLOS UE according to LOS and NLOS column in Table 1 or Table 2, respectively.

The CDF of mean value of ZoD spread for LOS and NLOS for Rural and Dense Urban test environment are provided in Annex F.

**Results**

Mean value of ZoD spread

According to the above-mentioned method, the mean value of ZoD in degree is shown in Table 2-23, and the CDF figures are provided in Annex 1.

Table 2-23 Mean value of ZoD spread for Dense Urban and Rural – eMBB test environment

Parameters	Dense Urban-eMBB				Rural-eMBB	
	Config A (4 GHz)		Config B (30 GHz)		Config A/B (700 MHz/4 GHz)	
Link-level Channel model	LOS: CDL/TDL- v	NLOS: CDL/TDL- iii	LOS: CDL/TDL-v	NLOS: CDL/TDL-iii	LOS: CDL/TDL- v	NLOS: CDL/TDL- iii
ZoD angular spreads scaling parameter $AS_{desired}$ (degree)	3.3	4.6	TBD from 50%-tile point of CDF of ZoD spread	TBD from 50%-tile point of CDF of ZoD spread	1.25	1.44

### SINR Distribution

In this section, the evaluation results for mobility is provided. In Figure 2.8, the pre-processing SINR CDFs for eMBB test environment are provided. The assumptions are provided in Appendix 2.

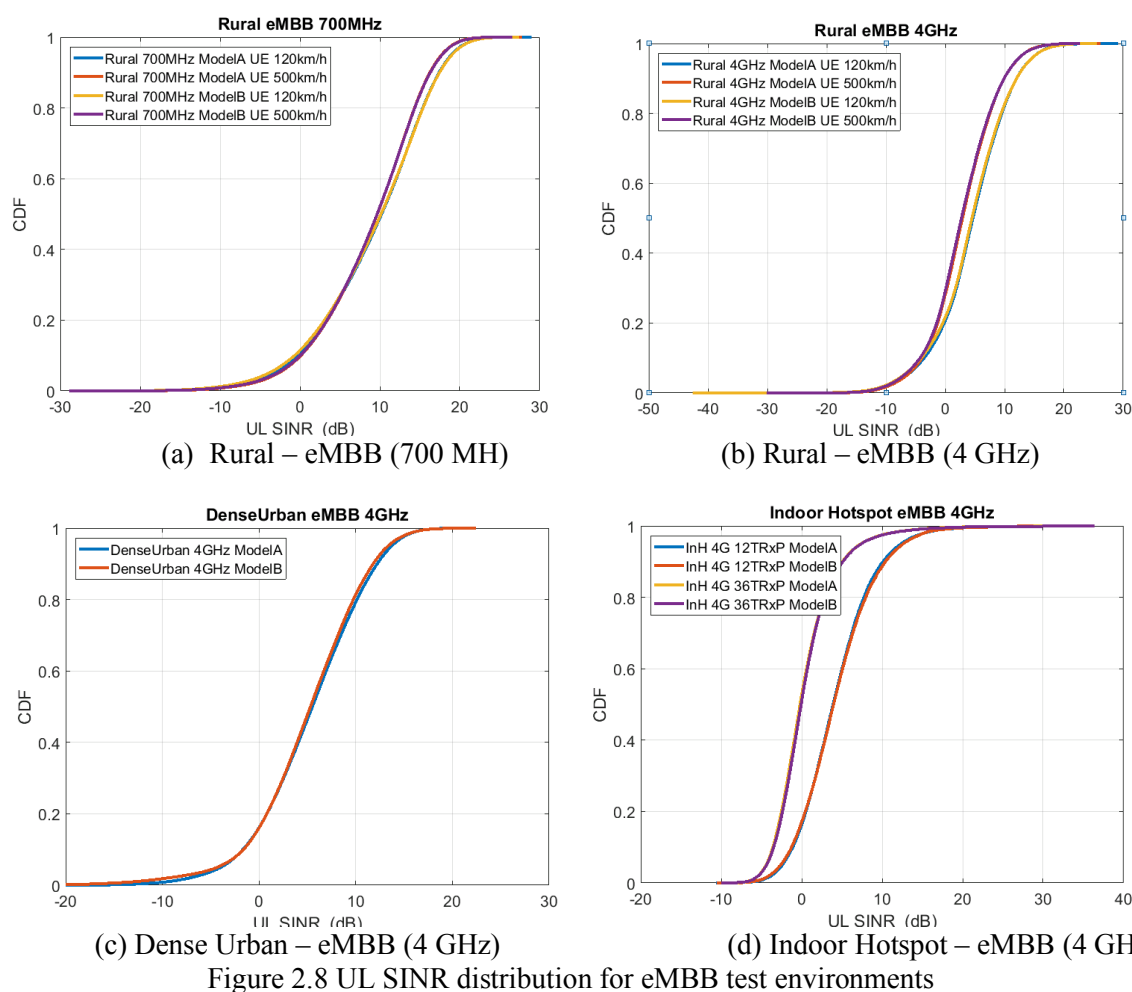

Based on the above figures, the 50%-tile point of the CDF for different test environments are listed in Table 2-24.

Table 2-24 The 50%-tile point of SINR CDF for different test environments

Test environment	Evaluation configuration	UE mobility	50%-tile point of SINR CDF (dB)	
			Channel model A	Channel model B
Rural – eMBB	Config. A (700 MHz)	120 km/h	10.21	10.14
		500 km/h	9.67	9.65
Rural - eMBB	Config. B (4 GHz)	120 km/h	4.66	4.50
		500 km/h	2.90	2.72
Dense Urban – eMBB	Config. A (4 GHz)	30 km/h	5.52	5.32
Indoor Hotspot – eMBB (12 TRxP)	Config. A (4 GHz)	10 km/h	3.90	3.95
Indoor Hotspot – eMBB (36 TRxP)	Config. A (4 GHz)	10 km/h	-0.21	-0.07

### Link Properties

In this section, the uplink link level evaluation results for mobility is provided, and the results of NR for different test environments are listed in Table 2-25.

Table 2-25 The uplink link level evaluation results for different test environments for NR

Test environment	ITU requirement (bit/s/Hz)	Evaluation configuration	Channel Model	50%-tile point of SINR CDF (dB)	Uplink SE (bit/s/Hz)			
					FDD		TDD	
					NLOS	LOS	NLOS	LOS
Indoor Hotspot – eMBB (12 TRxP)	1.5	Config. A (4 GHz)	Channel model A	3.90	1.75	2.05	1.59	1.94
			Channel model B	3.95	1.75	2.07	1.60	1.95
Dense Urban – eMBB	1.12	Config. A (4 GHz)	Channel model A	5.52	1.92	2.22	1.82	2.17
			Channel model B	5.32	1.89	2.19	1.79	2.06
Rural – eMBB (120 km/h)	0.8	Config. A (700 MHz)	Channel model A	10.21	2.32	2.90	2.10	2.63
			Channel model B	10.14	2.31	2.90	2.09	2.63
		Config. B (4 GHz)	Channel model A	4.66	1.30	1.74	1.18	1.57
			Channel model B	4.50	1.28	1.68	1.16	1.52
Rural – eMBB (500 km/h)	0.45	Config. A (700 MHz)	Channel model A	9.67	2.07	2.64	1.88	2.39
			Channel model B	9.65	2.07	2.64	1.87	2.39
		Config. B (4 GHz)	Channel model A	2.90	0.92	1.33	0.84	1.22
			Channel model B	2.72	0.91	1.33	0.83	1.22

## Evaluation Report

Minimum technical performance requirements item	Category	Required value at the given Mobility (km/h)		Value (Bits/s/Hz)	Requirement met?	Comment
		Normalized traffic channel link data rate (Bit/s/Hz)	Mobility (km/h)			
Mobility	Indoor Hotspot-eMBB	1.5	10	1.59-2.07	Yes	
	Dense Urban-eMBB	1.12	30	1.79-2.17	Yes	
	Rural-eMBB	0.8	120	1.28-2.90	Yes	
		0.45	500	0.83-2.64	Yes	

### 2.2.3.4 RELIABILITY

#### Requirements

Reliability relates to the capability of transmitting a given amount of traffic within a predetermined time duration with high success probability. Reliability is the success probability of transmitting a layer 2/3 packet within a required maximum time, which is the time it takes to deliver a small data packet from the radio protocol layer 2/3 SDU ingress point to the radio protocol layer 2/3 SDU egress point of the radio interface at a certain channel quality. This requirement is defined for the purpose of evaluation in the URLLC usage scenario. The minimum requirement for the reliability is  $10^{-5}$  success probability of transmitting a layer 2 PDU (protocol data unit) of 32 bytes within 1 ms in channel quality of coverage edge for the Urban Macro-URLLC test environment, assuming small application data (e.g. 20 bytes application data + protocol overhead). Proponents are encouraged to consider larger packet sizes, e.g. layer 2 PDU size of up to 100 bytes.

#### Evaluation Methodology

Reliability is the success probability of transmitting a layer 2/3 packet within a required maximum time, which is the time it takes to deliver a small data packet from the radio protocol layer 2/3 SDU ingress point to the radio protocol layer 2/3 SDU egress point of the radio interface at a certain channel quality.

This requirement is defined for the purpose of evaluation in the URLLC usage scenario.

The minimum requirement for the reliability is  $10^{-5}$  success probability of transmitting a layer 2 PDU (protocol data unit) of 32 bytes within 1 ms in channel quality of coverage edge for the Urban Macro-URLLC test environment, assuming small application data (e.g. 20 bytes application data + protocol overhead).

The evaluation of reliability is based on a combination of system level and link level simulations. The system level simulation can provide the operation point (e.g., average SINR) from a multi-cell multi-user environment's perspective, while the link level simulation can further show how a RIT/SRIT can achieve the balance between reliability and latency with affordable complexity (as only a single link needs to be explicitly modelled) at the said operation point.

The following steps have been performed in order to evaluate the reliability requirement using system-level simulation followed by link-level simulations.

**Step 1:** Run downlink or uplink full buffer system-level simulations of candidate RITs/SRITs using the evaluation parameters of Urban Macro-URLLC test environment see § 8.4.1 below, and collect overall statistics for downlink or uplink SINR values, and construct CDF over these values.

**Step 2:** Use the CDF for the Urban Macro-URLLC test environment to save the respective 5<sup>th</sup> percentile downlink or uplink SINR value.

**Step 3:** Run corresponding link-level simulations for either NLOS or LOS channel conditions using the associated parameters in the Table 8-3 of this Report, to obtain success probability, which equals to  $(1-P_e)$ , where  $P_e$  is the residual packet error ratio within maximum delay time as a function of SINR taking into account retransmission.

**Step 4:** The proposal fulfils the reliability requirement if at the 5<sup>th</sup> percentile downlink or uplink SINR value of Step 2 and within the required delay, the success probability derived in Step 3 is larger than or equal to the required success probability. It is sufficient to fulfil the requirement in either downlink or uplink, using either NLOS or LOS channel conditions.

It is worth mentioning that in **Step 3**, the whole transmission procedure of DL/UL should be taken into account, including both control and data channels, and in some case, maybe other scheduling related channels should also be considered, as they will impact both latency and reliability respectively.

## Results

### System-level simulations

The assumptions for the system-level simulations (SLS) are given in Table 2-26, as are the results for the two test-configurations A and B (4 GHz and 700 MHz respectively; detailed specifications of these test configurations can be found in ITU-R M.2412, refer Annex K).

For configuration A, the total gain (including antenna gain) is presented in *Figure 2.9* for UMa channel models A and B. The resulting SINR at full load (cell utilization 1) is illustrated in *Figure 2.10*. The cell-edge (5<sup>th</sup> percentile) SINR is found to be 1.98 dB (on the DL) and 0.81 dB (on the UL) for channel model UMa A, and 1.98 dB (DL) and 1.77 dB (UL) for channel model UMa B as shown in *Figure 2.11*.

For configuration B, the total gain (including antenna gain) is given in *Figure 2.12*. The resulting SINR at full load (cell utilization 1) is given in *Figure 2.13*. The cell-edge (5<sup>th</sup> percentile) SINR is found to be 0.16 dB (on the DL) and 0.83 dB (on the UL) for channel model UMa A and -0.06 dB (DL) and 0.65 dB (UL) for channel model UMa B as shown in *Figure 2.14*.

*Table 2-26 Assumptions of the system-level simulations*

<b>Configuration Parameters</b>	<b>URLLC configuration A</b>	<b>URLLC configuration B</b>
Carrier frequency	4 GHz	700 MHz
Base station Antenna Height	25 m	25 m
Inter-site distance	500 m	500 m
Bandwidth	20 MHz	20 MHz
Device deployment	80% outdoor, 20% indoor	80% outdoor, 20% indoor
Number of UE antenna elements	4	4
UE noise figure	7	7
UE power	23 dBm	23 dBm
Path loss model	UMa A/B with SCM (for ZOD)	UMa A/B with SCM (for ZOD)
BS antenna VxH (vs x Hs x P)	4 x8 (2x1x2)	4 x4 (2x1x2)
BS Transmit power	49 dBm	49 dBm
BS noise figure	5	5
Electrical down tilt	9 degrees	9 degrees
Traffic model	Full buffer	Full buffer
UL power control	Alpha=1, P0=-106dBm	Alpha=1, P0=-106dBm
UL allocation	5PRB (10UEs sharing 50PRBs)	5PRB (10UEs sharing 50PRBs)

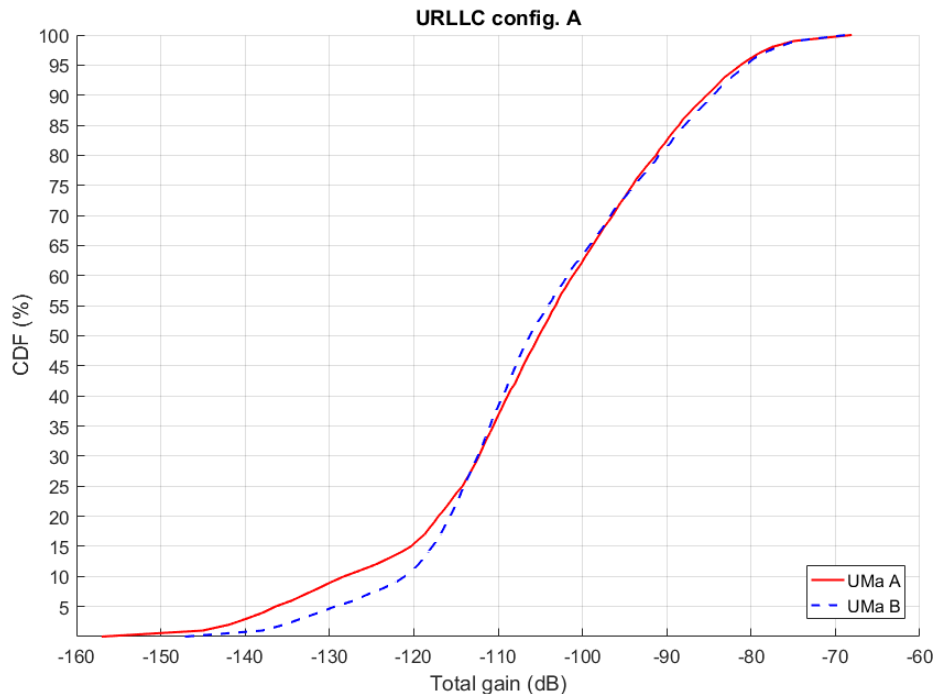

Figure 2.9: Total gain for urLLC configuration A.

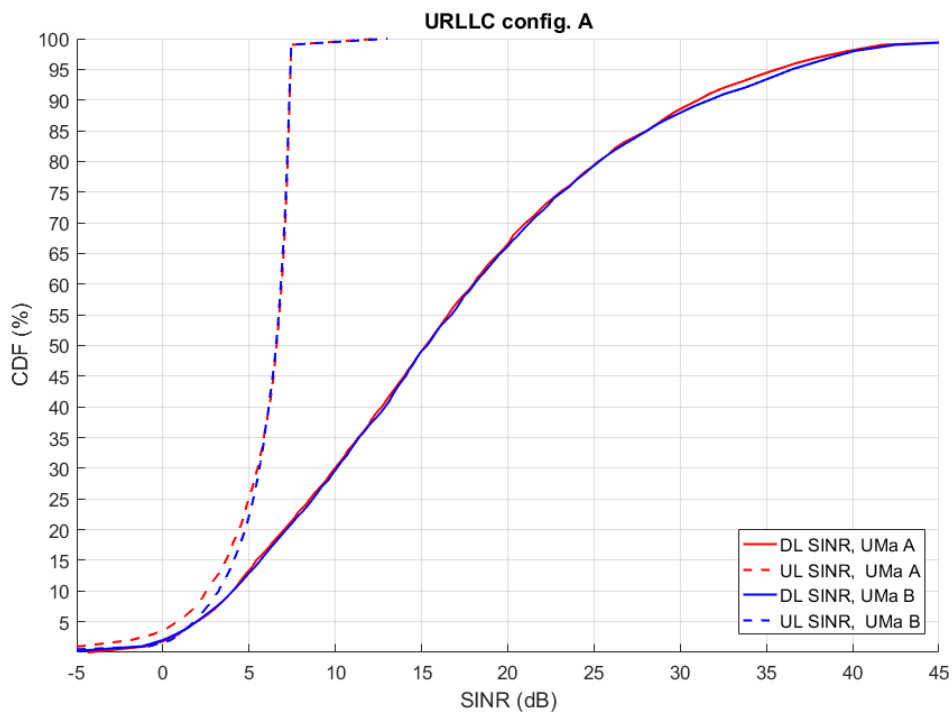

Figure 2.10: SINR distribution for urLLC configuration A.



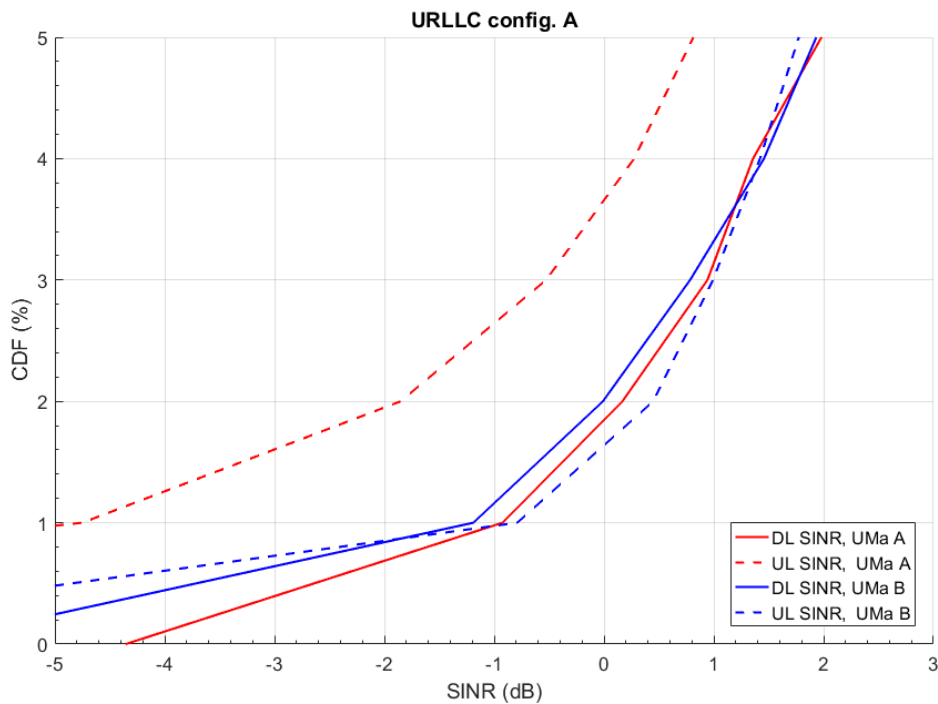
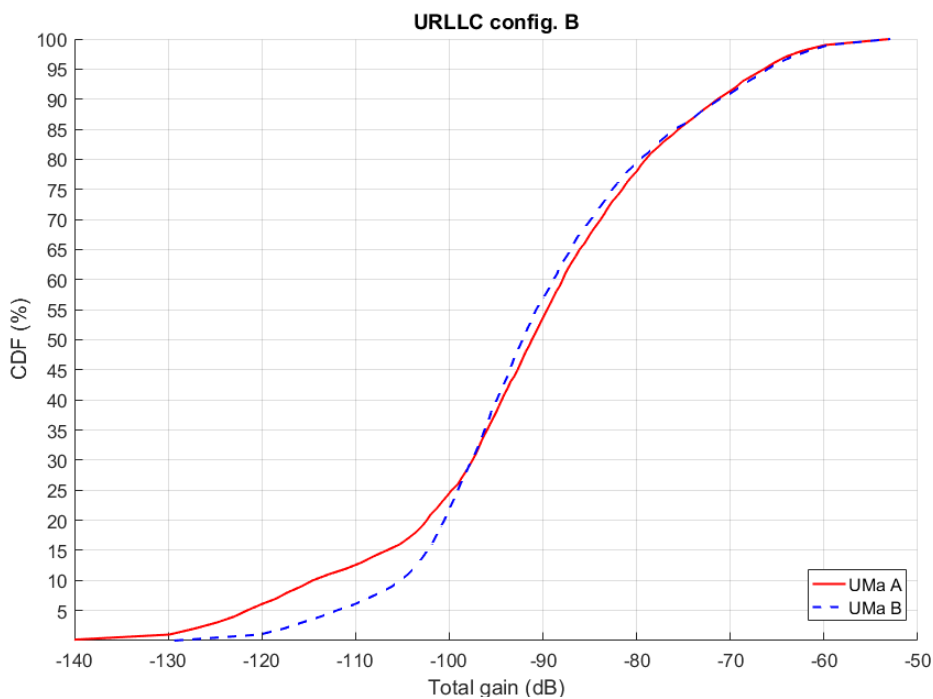

Figure 2.11: SINR distribution at 5th percentile for URLLC configuration A.

The cell-edge SINR for URLLC Conf. A is approximately 1.98 dB (DL) and 0.81 dB (UL) for channel model UMa A, and 1.93 dB (DL) and 1.77 dB (UL) for channel model UMa B.



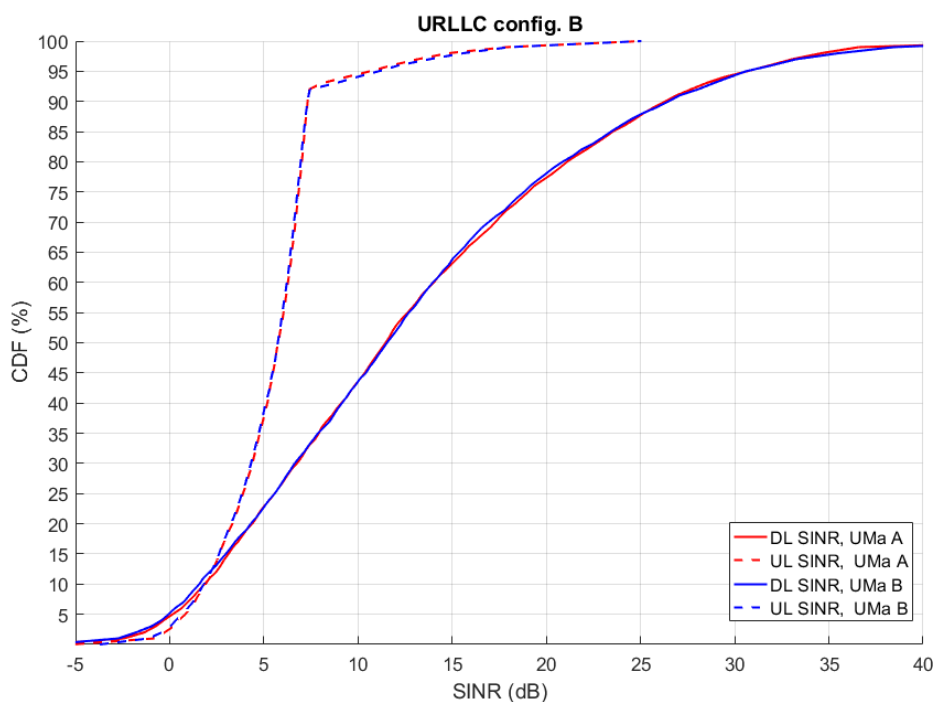

Figure 2.13: SINR distribution for urLLC configuration B.

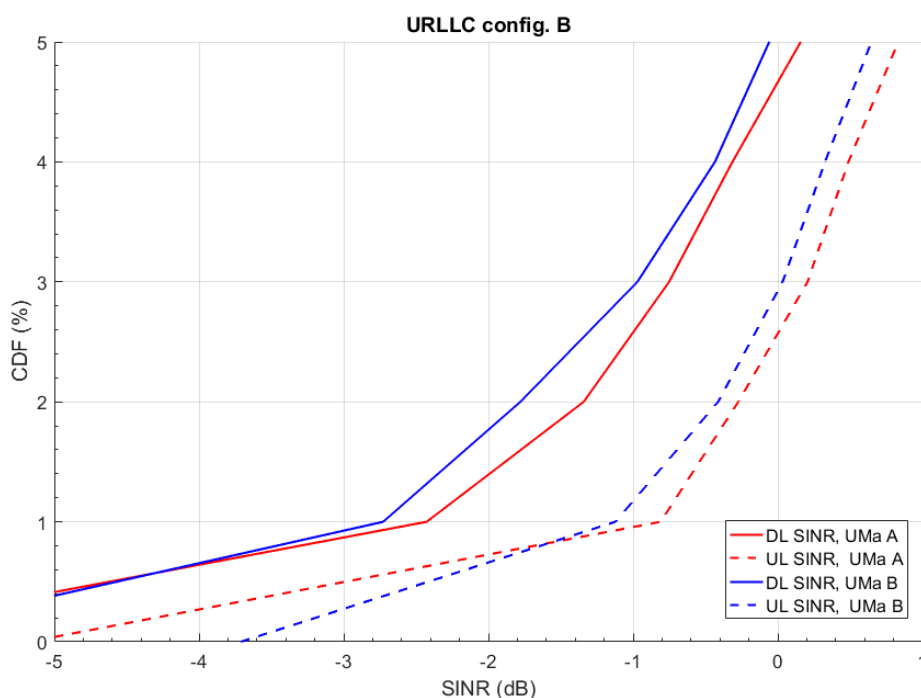

Figure 2.14: SINR distribution at 5th percentile for urLLC configuration B.

### Link Level Simulations

The assumptions on the link-level simulations (LLS) are given in Table 2-27. Two different datasets are used for data and control channels. For PDCCH, a DCI of size 40 bits, excluding CRC, is assumed. For PUCCH a 1-bit UCI is assumed, carried by PUCCH format 0 with 20s (symbols) duration and frequency hopping.

The resulting BLER as a function of SNR for the control channels is shown in Figure 2.15, and for the data channels in Figure 2.16 and Figure 2.17.

Table 2-27 Assumptions on the link-level simulations

<b>Channel model</b>	TDL-C with 300ns delay spread
<b>Carrier</b>	700MHz
<b>Bandwidth</b>	20 MHz
<b>Subcarrier spacing</b>	30 kHz
<b>Antenna setting</b>	2TX 2RX (data), 1TX 2RX (control)
<b>Tx diversity</b>	Rank 1 (TX diversity precoding based on CSI reports with 5 slots periodicity).
<b>Speed</b>	3km/h
<b>Channel estimation</b>	Practical: <ul style="list-style-type: none"> <li>• 4os mini-slot - 1os front-loaded DMRS type 2</li> <li>• 7os mini-slot - 2os front-loaded DMRS type 2</li> </ul>
<b>Frequency allocation</b>	Frequency allocation type 1 (contiguous)
<b>Time allocation</b>	4os and 7os allocations type B
<b>PUCCH</b>	1 A/N bit, PUCCH format 0 with 2- symbol duration and frequency hopping between band edges
<b>PDCCH</b>	Polar codes, 40b payload excl. CRC. Distributed CCEs
<b>Data</b>	LDPC, BG2, 256b

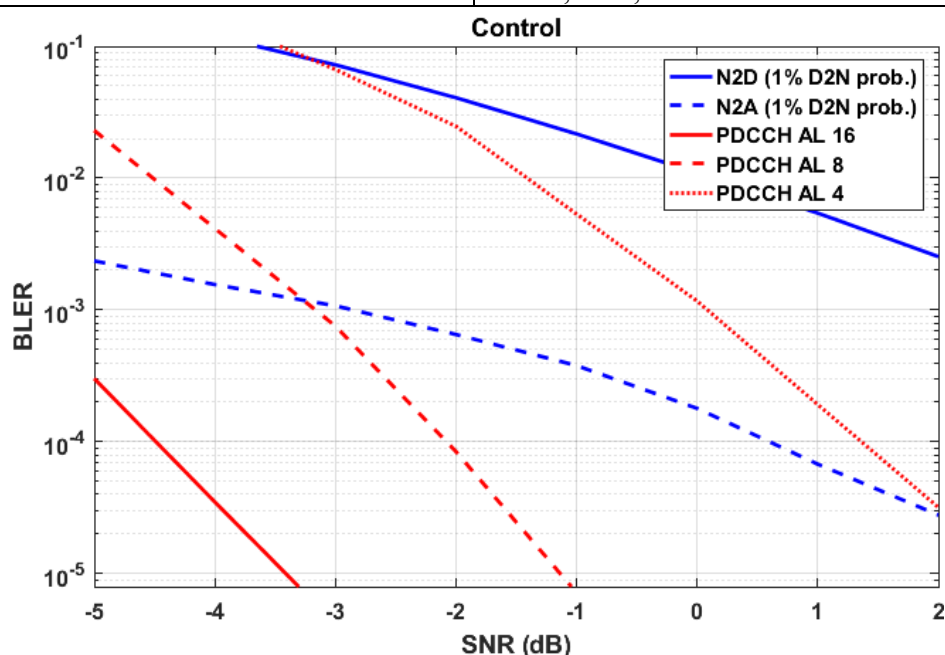

Figure 2.15: Sequence selection Short PUCCH and PDCCH BLER as function of SNR.

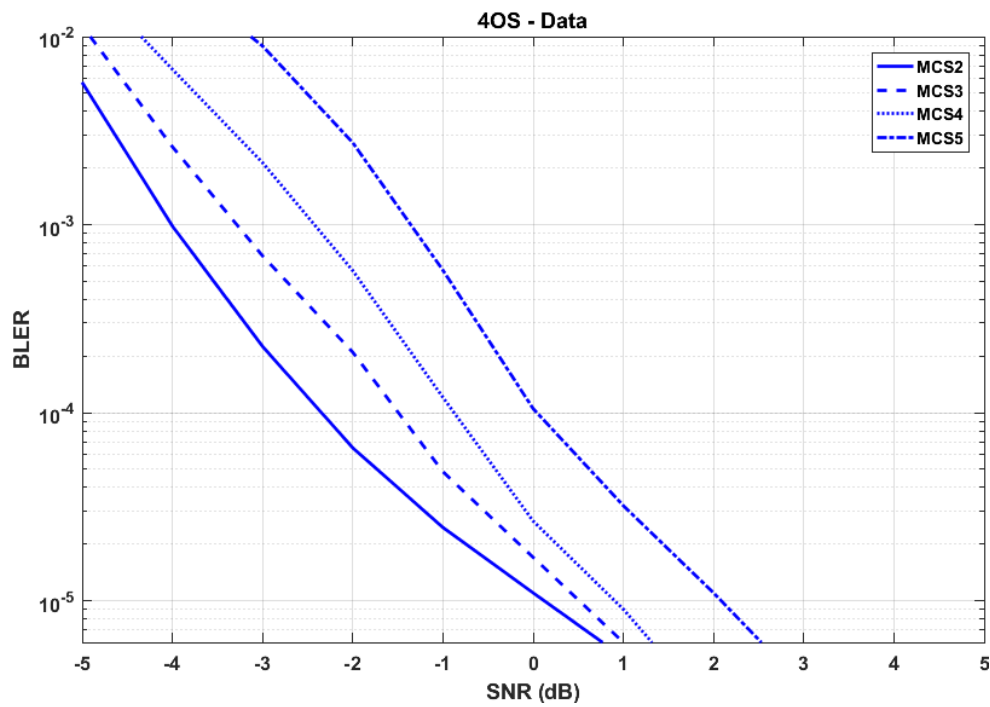

Figure 2.16: 4OS-Data (1st attempt) LDPC BLER for QPSK with different MCS as function of SNR.

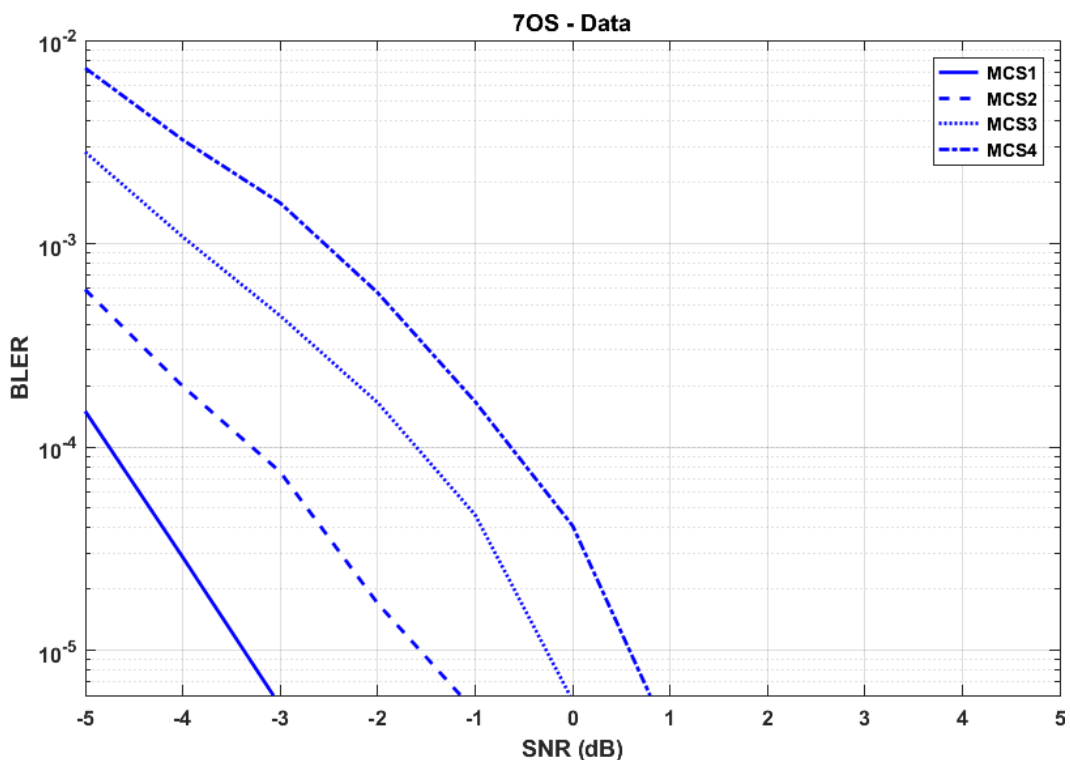

Figure 2.17: 7OS-Data (1st attempt) LDPC BLER for QPSK with different MCS as function of SNR.

## Total reliability

With some exceptions, the discussion here assumes that the retransmissions are uncorrelated, which is reasonable to assume if they are done on a different frequency allocation. In the following, the success probabilities are written on the channel level according to Table 2-28, and expressions found for the total success rate  $p_t = 1 - \varepsilon$ , where  $\varepsilon$  is the residual error rate.

*Table 2-28 Success probabilities for calculating total reliability*

Probability	Description
$p_0$	Success of SR detection
$p_1$	Success of PDCCH transmission
$p_2$	Success of PDSCH/PUSCH transmission
$p_3$	Success of PUCCH NACK detection
$p_4$	Success of PUCCH DTX detection

### **DL data, HARQ-based**

On the DL, the total reliability can be described after  $N$  transmissions as:

$$p_t = \sum_{n=1}^N \sum_{i=1}^n \left\{ \binom{n-1}{n-i} [(1-p_1)p_4]^{n-i} p_1 p_{2,i} \prod_{j=1}^{i-1} p_1 p_3 (1-p_{2,j}) \right\}$$

where for any positive integer  $k$ ,  $p_{2,k}$  is the probability of a data block being correctly received after exactly  $k$  transmissions are soft-combined. In this expression, the DL control transmissions are seen as uncorrelated with each other and with data. This is an approximation, but can be motivated by, for example, moving the DL control between attempts. The data attempts are correlated with each other.

### **UL data, configured grant**

With configured grant-based UL scheduling instead, the SR step and the first DL control can be removed, and the total reliability can be described as:

$$p_t = p_{2,1} + (1-p_{2,1}) \sum_{n=2}^N p_1 p_{2,n} \prod_{i=2}^{n-1} (1-p_1 p_{2,i})$$

Here the PDCCH reliability starts from the first retransmission, assuming perfect energy detection performance on the PUSCH resource.

## Reliability estimate urLLC configuration B, UMa B

Accordingly, based on the above expressions for DL and UL data, while considering the link-level simulation results, the total reliability can be evaluated. By observation at the lower percentiles of the SINR distributions for urLLC configuration B, UMa B, the channel BLER can be found at the corresponding DL and UL SINR points. The total error rates for DL and UL data, respectively, can then be computed.

The results are shown in Figure 2.18 through Figure 2.21.

AL16 is assumed for PDCCH and 1% D2A level for PUCCH. On the UL, SPS is assumed with a configured resource every TTI. For both DL and UL, 1-3 transmission attempts (including HARQ retransmissions) are considered. The data transmissions are assumed to be correlated and are soft-combined.

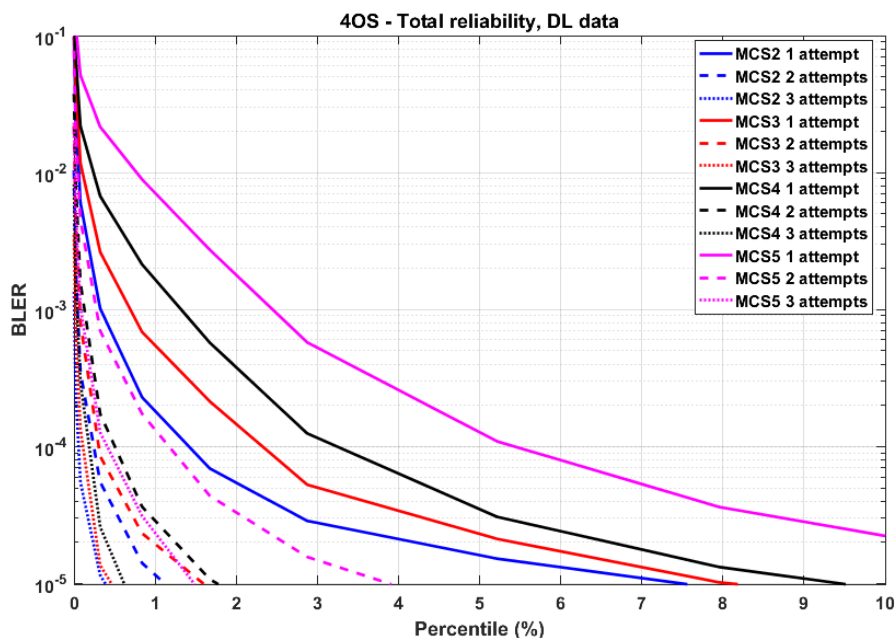

Figure 2.18: Total reliability for 4OS – DL data with 1-3 HARQ transmissions at lowest percentiles assuming correlated transmissions.

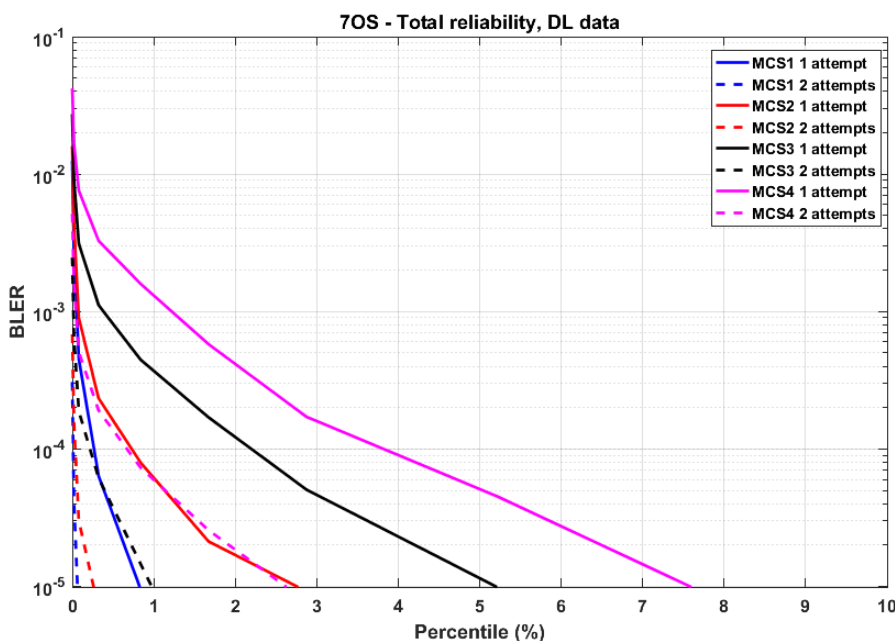

Figure 2.19: Total reliability for 7OS – DL data with 1-3 HARQ transmissions at lowest percentiles assuming correlated transmissions.

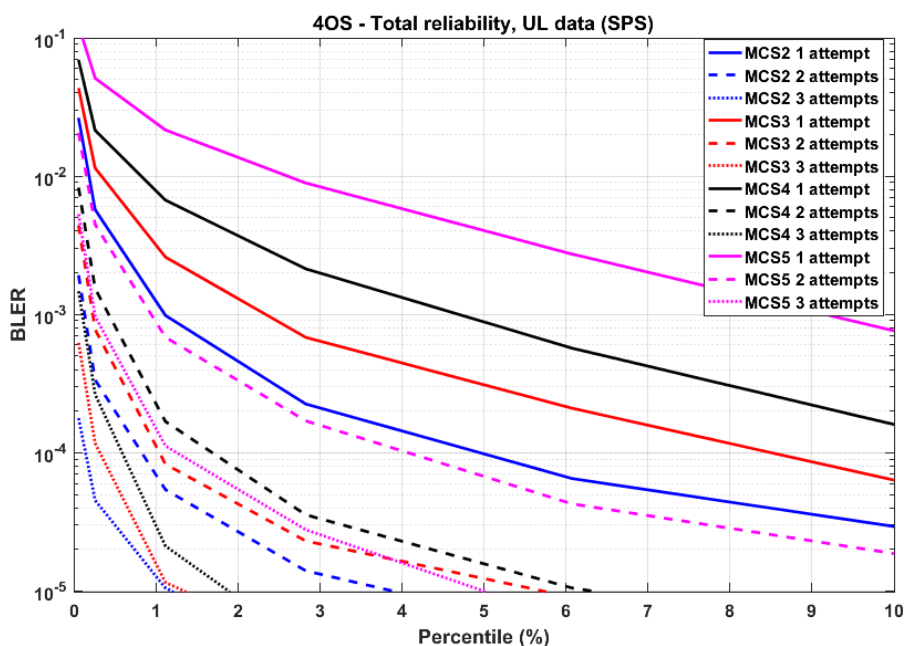

Figure 2.20: Total reliability for 4OS UL data with 1-2 HARQ transmissions at lowest percentiles with SPS-based scheduling assuming correlated transmissions.

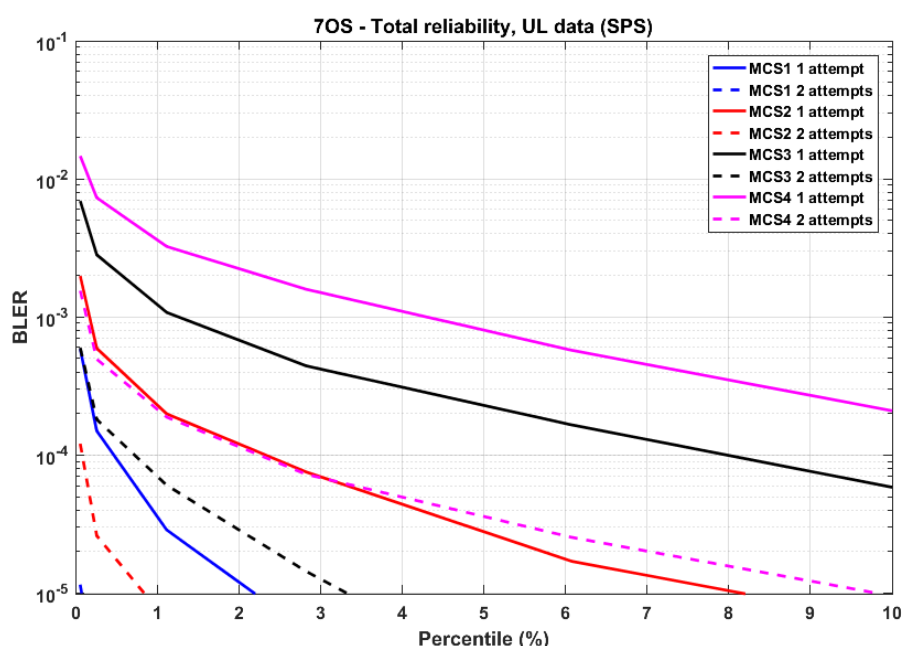

Figure 2.21: Total reliability for 7OS UL data with 1-2 HARQ transmissions at lowest percentiles with SPS-based scheduling assuming correlated transmissions.

**Packet size**

The ITU requirement calls for a packet size of 32B fulfilling the latency and reliability targets. With QPSK modulation and a coding rate from MCS1 to MCS5, along with an overhead of one OFDM symbol, the required number of PRBs is given in Table 2-29. Here, the TBS is assumed to be exactly 32B and CRC is not considered.

Table 2-29 Required #PRBs for 32B packet and 1 OFDM symbol overhead, at different coding rates

#PRBs	14-os TTI	7-os TTI	4-os TTI	2-os TTI
Code rate MCS1	22	46	92	274
Code rate MCS2	17	37	73	219

<b>Code rate MCS3</b>	14	29	57	171
<b>Code rate MCS4</b>	11	24	47	141
<b>Code rate MCS5</b>	9	19	37	111

### Total latency

In a companion paper, the UP latency was evaluated for a sequence of transmissions. It was found that DL and configured-grant UL transmissions with 7-os and 30 kHz SCS are possible within the latency bound of 1ms, as shown in Table 2-30. Thus, the ITU reliability of  $10^{-5}$  error within 1 ms can be met.

Table 2-30 Maximum #transmissions, including retransmissions, in FDD within 1ms.

#TX within 1ms	15kHz SCS				30kHz SCS				120kHz SCS			
	14-os TTI	7-os TTI	4-os TTI	2-os TTI	14-os TTI	7-os TTI	4-os TTI	2-os TTI	14-os TTI	7-os TTI	4-os TTI	2-os TTI
<b>DL data</b>	0	0	0	1	0	1	1	2	1	2	2	3
<b>UL data (SPS)</b>	0	0	0	1	0	1	1	2	1	1	1	2

### Evaluation Report

Minimum technical performance requirements item	Category	Required value	Value(Bits/s/Hz)	Requirement met?	Comment
Reliability	Urban Macro-URLLC	$10^{-5}$ success probability of transmitting a layer 2 PDU (protocol data unit) of 32 bytes within 1 ms	With 1 transmission using MCS1, the reliability target of $10^{-5}$ error can be met on the DL and the UL	Yes	

### 5GIF Observation

- The cell-edge SINR for urLLC configuration A is approximately 1.98 dB (DL) and 0.81 dB (UL) for channel model UMa A and 1.93 dB (DL) and 1.77 dB (UL) for channel model UMa B.
- The cell-edge SINR for urLLC configuration B is approximately 0.16 dB (DL) and 0.83 dB (UL) for channel model UMa A and -0.06 dB (DL) and 0.65 dB (UL) for channel model UMa B.
- With 1 transmission using MCS1, the reliability target of  $10^{-5}$  error can be met on the DL and the UL (with a configured grant).
- With MCS1 and a 7-os mini-slot, 46 PRBs are required for a 32B packet.
- With 30 kHz SCS and 7-os mini-slot, 1 transmission can be made in FDD mode within 1 ms



## 2.3 Similarity with other Candidate Technologies

Given the time and resources, the 5GIF IEG could only do the complete evaluation of the 3GPP NR RIT and the NB-IoT component technology. While this was sufficient to report the complete evaluation of three candidate technologies (IMT-2020/14 (3GPP RIT), 15 (China) and 16 (Korea)), it could only account to the partial evaluation of two remaining technologies (13\* (3GPP SRIT) and 17\* (DECT)). Therefore, our members paid some late attention to those technologies that couldn't get evaluated by us. Their primary interest was positioning those technologies with respect to the 3GPP NR technology (IMT-2020/14), which has already become commercial in several markets. In this chapter we provide some of those findings.

### 2.3.1 Commonality of the eMBB component

Enhanced Mobile Broadband (eMBB) is one of three use cases addressed by the 3GPP NR (IMT-2020/14). The design and development of 3GPP NR scopes it as an extension to existing 3GPP LTE-A services. These services are commercial in several markets and are in track to go far beyond just enabling faster download speeds. The major difference with respect to currently deployed LTE is the support of various physical layer numerologies. Making the physical layer scalable allows to properly address new services such as low latency or millimeter communications. To enable the early rollout of eMBB services, in March 2017 the 3GPP's RAN Group committed to finalise the Non-standalone (NSA) 5G NR variant by March 2018. The NSA mode uses the existing 4G network, supplemented by 5G NR carriers to boost data rates and reduce latency. The Standalone (SA) variant introduced later makes use of a new 3GPP 5G core network architecture.

Our studies on the candidate technologies concluded that the eMBB component of the NR RIT from 3GPP (IMT-2020/14) is being used by few other proponents:

- i. IMT-2020/15 by China
- ii. IMT-2020/16 by Korea, and
- iii. IMT-2020/17 by ETSI DECT

This would mean that network and devices implementing the eMBB component of IMT-2020/14 will be able to roam and interoperate with the remaining four technologies without any technology constraints.

	eMBB	mMTC	uRLLC
IMT-2020/13 3GPP SRIT	LTE-Adv	eMTC / NB-IoT	3GPP NR
IMT-2020/14 3GPP RIT	3GPP NR	3GPP NR	3GPP NR
IMT-2020/15 China RIT	3GPP NR	NB-IoT	3GPP NR
IMT-2020/16 Korea RIT	3GPP NR	3GPP NR	3GPP NR
IMT-2020/17 DECT RIT	3GPP NR	DECT NR	DECT NR
IMT-2020/18 Nufront RIT	Nufront	Nufront	Nufront
IMT-2020/19 TSDSI RIT	TSDSI NR*	TSDSI NB-IoT*	TSDSI NR*

Figure 2.22 Commonality across candidate technologies

Furthermore, the 3GPP NR RIT continues to evolve inside 3GPP. The candidate RIT's that reference NR (Sec 2.3.1) will benefit from these advancements as and when they become available.

### 2.3.2 The Non-standalone (NSA) mode

The first rollout of 5G networks are NSA deployments that focus on enhanced mobile broadband to provide higher data-bandwidth and reliable connectivity. They are in line with the 3GPP specification that early rollouts of 5G networks and devices be brought under NSA operation – meaning, 5G networks will be aided by existing 4G infrastructure. For service providers who are looking to deliver mainly high-speed connectivity to consumers with 5G-enabled devices already today, NSA mode makes the most sense, because it allows them to leverage their existing network assets rather than deploy a completely new end-to-end 5G network. This is a great value add from 3GPP, and operators who made large LTE investments get to recover, and in the meantime get to gradually invest in NR roll outs.

The NSA mode uses the existing 4G network, supplemented by 5G NR carriers to boost data rates and reduce latency. The Standalone (SA) variant introduced later makes use of a new 3GPP 5G core network architecture. Non-standalone 5G networks rely on an LTE core and radio access network with the addition of a 5G carrier using a 3GPP standardized solution called as E-UTRAN New Radio – Dual Connectivity (ENDC). ENDC allows user equipment to connect to an LTE enodeB that acts as a master node and a 5G gnodeB that acts as a secondary node. From the ITU front, this corresponds to the scenario where the IMT-2020 candidate technology works alongside an IMT-Advanced technology, from the same device.

Our studies on the candidate technologies concludes that following candidate technologies can work alongside LTE-Advanced, an IMT-Adv technology:

- i. IMT-2020/14 by 3GPP
- ii. IMT-2020/15 by China
- iii. IMT-2020/16 by Korea, and
- iv. IMT-2020/17 by ETSI DECT

This would further mean that an operator network supporting LTE-A can be upgraded to support NR radio in NSA mode, without any technology constraints.

### 2.3.3 Idle/Inactive mode behaviour and Initial Access Process

At any given instance, the UE may be in an idle/inactive mode where UE does not have dedicated connection, or in a connected mode where UE have dedicated radio resources. The initial access procedure (also called random access, RACH procedure in 3GPP) helps to get the initial uplink grant for UE and helps in performing synchronization with the gNB (i.e. network). It covers Random Access procedure initialization, Random Access Resource selection, Random Access Preamble transmission, Random Access Response reception, Contention Resolution and Completion of the random-access procedure. UE uses initial access procedure to move from idle mode to connected mode. In idle mode the mobility is achieved by means of cell selection and reselection procedures.

As per the 3GPP NR specifications (IMT-2020/14), the UE may be in either of the following states according to the status of the radio resources assigned to the UE: RRC-IDLE, RRC-INACTIVE or RRC-CONNECTED.

In the RRC-IDLE state, UE monitors the downlink common control channels and monitors the serving cell strength and triggers cell reselection based on serving cell and neighbour cell measurements. In this state the UE selects cell for its camping only if it satisfies the cell selection criteria (C1). This criterion consists of minimum receive level for the cell broadcasted from the cell and the power compensation which depends on the transmission power difference between based station and mobile station power class. Here the coverage for idle mode is determined by the RXLEV-MIN value and the maximum power corresponds to the power class of the UE. As per the idle mode behaviour defined in various

IMT-2020 technologies based on NR (3GPP, China, Korea, ETSI and TSDSI), this performance is same across all the technologies as the idle mode behaviour is common across these technologies.

RRC-INACTIVE state is like RRC-IDLE state with difference that the UE and NW stores the UE AS context so that fast reactivation via Resume procedure will be possible. The idle mode behaviour including cell selection and reselection remains same as RRC-IDLE state across all the candidate technologies based on NR.

In RRC-CONNECTED state UE and Network have active RRC connection and scheduler operation is active for the UE. The UE monitors PDCCH continuously for scheduling grant for uplink and downlink transmission in this state. In this state, the radio link of serving cell is monitored in every radio frame and radio link failure is detected based on the radio link quality observed on the serving cell. The radio link quality includes the monitored serving cell signal strength, successful deliver of uplink and downlink RLC layer operations. On detection radio link failure, the UE inters into RRC-IDLE mode. The radio link quality in RRC-CONNECTED state is overall governed by the link level performance of least performing data/control channel associated with this state.

The state transition between these states is illustrated using the Figure below (Ref 3GPP TS 38.300).

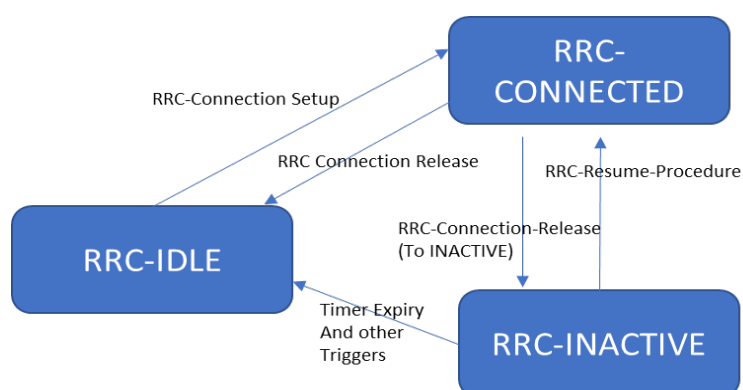

The UE moves from RRC-IDLE state to RRC-CONNECTED state via RRC Connection setup signalling procedure as illustrated below.

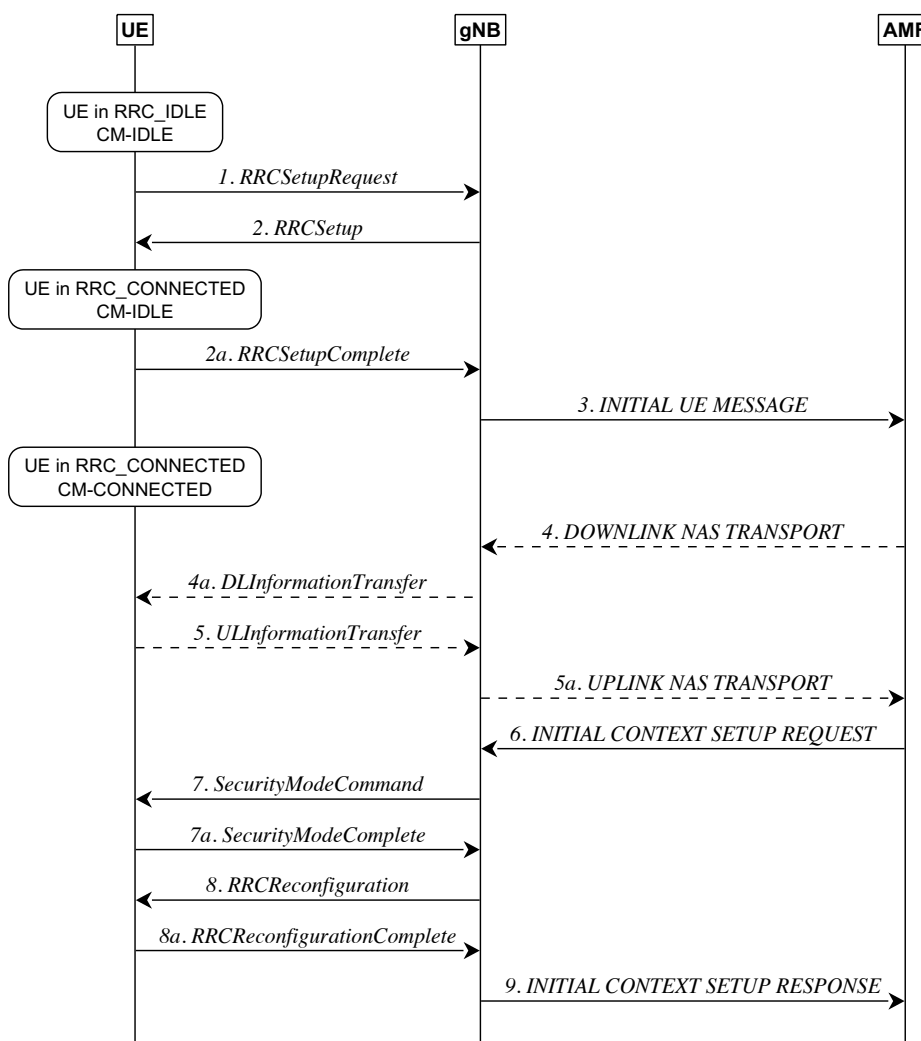

In the above procedure the trigger for the RRC connection setup (step 1) and the NW response to this message (step 2) are realized through random access procedure from UE. The random-access procedure involves the following steps.

1. UE sends Random access preamble. (PRACH channel).
2. NW sends Random access response via downlink PDSCH which is received by multiple UE. (Common downlink control channel). This contains the uplink grant and timing advance for the UE to send the RRC connection setup.
3. UE sends RRC connection setup in the uplink grant received from network (Step1 in the above figure).

The above-mentioned steps in random-access procedure is illustrated using the Figure below.

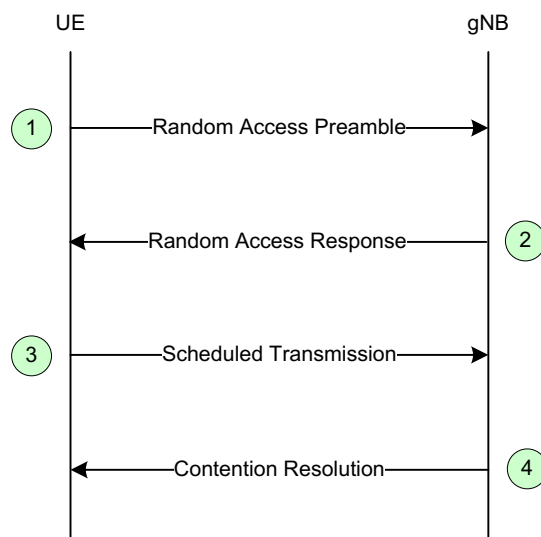

The successful completion of state transition from idle to connected state mainly depends on the coverage performance of random-access procedure explained above.

Our studies on the candidate IMT-2020 technologies further concludes that the following candidate technologies share the same initial access procedure:

- i. IMT-2020/14 by 3GPP
- ii. IMT-2020/15 by China
- iii. IMT-2020/16 by Korea, and
- iv. IMT-2020/17 by ETSI DECT (eMBB component)

The state transition signalling procedure and associated transmission power and coverage performance of the control channels remains same. Hence, we can conclude that the UE behaviour and the coverage performance in RRC-IDLE, RRC-INACTIVE and during state transition between these states is the same across these 3GPP NR based candidate technologies. The performance of connection establishment procedure at given coverage condition is same in all these technologies, which further means that any implementation based on these five candidate technologies will be identical in terms of implementation and performance, until this point of call establishment.

## 2.4 Conclusion

In this chapter, we have provided technical evaluation for the 3GPP candidate technologies in IMT-2020/13 (SRIT) and IMT-2020/14 (RIT). Based on our evaluation,

1. The 3GPP NR RIT in IMT-2020/14 meets all the requirement for IMT-2020 suitability
2. The NB-IoT technology in IMT-2020/13 meets the mMTC requirement for IMT-2020 suitability

Since the candidate technologies IMT-2020/15 and IMT-2020/16 are a combination of these technology aspects, they follow the similar disposition. Thus, the candidate technology IMT-2020/15 by China and IMT-2020/16 by Korea satisfy the requirements for IMT-2020 suitability.

### 3. Assessment of Candidate technology – DECT FORUM (IMT2020/17)

In this chapter, our assessment is based on the information the *revised* submission by TC DECT Forum submitted after WP5D#32, Bouzios, Brazil. This final revised submission **5D/1299** was discussed during the WP5D#34 meeting. We have used the information available from the Description Templates and specifications submitted by TC DECT Forum. Wherever, enough information was not available, we have referred to the assumptions given in the self-evaluation report in **5D/1299** and the clarifications during the discussion in SWG Evaluation included in the **IMT2020/26**. The DECT RIT contains two component technology – 3GPP NR (for eMBB usage scenarios) based on **IMT-2020/14** that is evaluated in chapter 2 and the DECT-NR component which is technically different from 3GPP NR and is the candidate component for meeting the performance requirements for URLLC and mMTC usage scenarios.

#### 3.1 COMPLIANCE TEMPLATES

This section provides templates for the responses that are needed to assess the compliance of a candidate RIT or SRIT with the minimum requirements of IMT-2020. We have independently assessed the candidate technology based on the characteristic template and DECT specifications referred in the submission by the proponents in **IMT2020/17**.

The compliance templates are based on ITU-R M.2411:

- Compliance template for services;
- Compliance template for spectrum; and,
- Compliance template for technical performance

As per the ITU-R Report M.2411, Section 5.2.4, the summary based on our evaluation for

##### 3.1.1 Services

*(M.2411 - Compliance template for services<sup>10</sup> 5.2.4.1)*

	Service capability requirements	5GIF comments
5.2.4.1.1	<p>Support for wide range of services</p> <p>Is the proposal able to support a range of services across different usage scenarios (eMBB, URLLC, and mMTC)?:</p> <p><del>YES</del>/ NO</p> <p>Specify which usage scenarios (eMBB, URLLC, and mMTC) the candidate RIT or candidate SRIT can support.</p>	<p>NO</p> <p>The proposal of DECT component RIT is expected to support URLLC and mMTC through the relevant performance requirements. Based on our evaluation, the DECT component <b>does not meet</b> the URLLC requirements (<i>Reliability</i>).</p> <p>Moreover, the independent evaluation of connection density requirements for mMTC scenario could not be done as the specifications and technical contents are unclear from the submission <b>5D/1299 (IMT-2020/17)</b></p>

##### 3.1.2 Spectrum

*(M.2411 - Compliance template for spectrum<sup>3</sup>, 5.2.4.2)*

	<b>Spectrum capability requirements</b>	<b>5GIF Comments</b>
5.2.4.2.1	<p><b>Frequency bands identified for IMT</b></p> <p>Is the proposal able to utilize at least one frequency band identified for IMT in the ITU Radio Regulations?:</p> <p><b>YES / NO</b></p> <p>Specify in which band(s) the candidate RIT or candidate SRIT can be deployed.</p>	<p>For DECT-2020 NR component RIT:</p> <p>The candidate RIT is designed to operate over:</p> <ul style="list-style-type: none"> <li>• The frequency bands currently allocated to DECT service (1880 MHz – 1900 MHz)</li> <li>• The frequency bands currently allocated to IMT-2000 FT service (1900 MHz to 1980 MHz and 2010 MHz to 2025 MHz)</li> </ul> <p>The DECT supports operation in 1710-2200 (ITU-R M.1036). There is no other details on support and operation of this technology in other IMT bands</p>
5.2.4.2.2	<p><b>Higher Frequency range/bands</b></p> <p>Is the proposal able to utilize the higher frequency range/band(s) above 24.25 GHz?: <b>YES / NO</b></p> <p>Specify in which band(s) the candidate RIT or candidate SRIT can be deployed.</p> <p>NOTE 1 – In the case of the candidate <b>SRIT</b>, at least one of the component RITs need to fulfil this requirement.</p>	<p><b>No information found</b> in the reference provided by their self evaluation report (5D/1299) - “ETSI TR 103 514” that make use of frequency range/band above 24.5 GHz.</p> <p>DECT is a SRIT submission and the 3GPP-NR RIT component supports mm wave bands. This is met by the 3GPP-NR component</p>

### 3.1.3 Technical Performance

#### 5.2.4.3 Compliance template for technical performance<sup>3</sup>

Table 3.1 : 3GPP-NR Component

<b>Characteristics for Evaluation</b>	<b>Usage Scenario</b>	<b>Requirement Met</b>	<b>5GIF Remark</b>
<b>5.2.4.3.1</b> Peak data rate (Gbit/s) (4.1)	eMBB	Yes(eMBB)	<i>Requirement met by the 3GPP-NR component, Evaluation in <b>Chapter 2</b> applies</i>
<b>5.2.4.3.2</b> Peak spectral efficiency (bit/s/Hz) (4.2)	eMBB	Yes(eMBB)	
<b>5.2.4.3.3</b> User experienced data rate (Mbit/s) (4.3)	eMBB	Yes(eMBB)	
<b>5.2.4.3.4</b> 5 <sup>th</sup> percentile user spectral efficiency (bit/s/Hz) (4.4)	eMBB	Yes(eMBB)	

<b>5.2.4.3.5</b> Average spectral efficiency (bit/s/Hz/ TRxP) (4.5)	eMBB	Yes(eMBB)	
<b>5.2.4.3.6</b> Area traffic capacity (Mbit/s/m <sup>2</sup> ) (4.6)	eMBB	Yes(eMBB)	<i>Requirement met by the 3GPP-NR component, Evaluation in Chapter 2 applies</i>
<b>5.2.4.3.7</b> User plane latency (ms) (4.7.1)	eMBB	Yes*(eMBB)	<i>Requirement met by the 3GPP-NR component, Evaluation in Chapter 2 applies</i>
<b>5.2.4.3.8</b> Control plane latency (ms) (4.7.2) 10ms is encouraged	eMBB	Yes*(eMBB)	<i>*For URLLC Scenario, DECT-NR needs to meet</i>
<b>5.2.4.3.10</b> Energy efficiency (4.9)	eMBB	Yes(eMBB)	<i>Requirement met by the 3GPP-NR component, Evaluation in Chapter 2 applies</i>
<b>5.2.4.3.12</b> Mobility classes (4.11)	eMBB	Yes(eMBB)	
<b>5.2.4.3.13</b> Mobility Traffic channel link data rates (bit/s/Hz) (4.11)	eMBB	Yes(eMBB)	<i>Requirement met by the 3GPP-NR component, Evaluation in Chapter 2 applies</i>
<b>5.2.4.3.14</b> Mobility interruption time (ms) (4.12)	eMBB	Yes (eMBB)	<i>Requirement met by the 3GPP-NR component, Evaluation in Chapter 2 applies</i> <i>*For URLLC Scenario, DECT-NR needs to meet</i>



Table 3.2 : DECT-2020-NR Component

Minimum technical performance requirements item (5.2.4.3.x), units, and Report ITU-R M.2410-0 section reference <sup>(1)</sup>	Category			Required Value	Value	Requirement met?	Comments
	Usage scenario	Test environment	Downlink or uplink				
5.2.4.3.7 User plane latency (ms) (4.7.1)	URLLC	Not applicable	Uplink and Downlink	1 ms	1.2064	No	Refer Section 3.2 (Analysis Aspects)
5.2.4.3.8 Control plane latency (ms) (4.7.2)	URLLC	Not applicable	Not applicable	20 ms (10 ms preferred)	Legacy DECT: >8.2501  DECT-2020: >12.2501	Yes	<b>Legacy DECT</b> Essential Overhead related to preamble, RACH etc not provided clearly  <b>DECT-2020</b> Essential Overhead related to preamble, RACH etc not found in the specification

5.2.4.3.11 Reliability (4.10)	URLLC	Urban Macro- URLLC	Downlink	99.999%	10.9213%~ 99.9215%	No	For evaluation configuration B (Carrier frequency = 700 MHz). Range: Frequency reuse scheme : 1. 1 DECT-2020 channel 2. 3 DECT-2020 channel 3. 7 DECT-2020 channel
			Uplink	99.999%	48.5944%~ 97.4825%	No	
5.2.4.3.14 Mobility interruption time (ms) (4.12)	URLLC	Not applicable	Not applicable	0	UNABLE TO EVALUATE	UNABLE TO EVALUATE	For the DECT-NR RIT component To clear specification to evaluate this metric
5.2.4.3.15 Bandwidth and Scalability (4.13)	Not applicable	Not applicable	Not applicable	At least 100 MHz	27.648 MHz	No	For the DECT-NR RIT component The only subcarrier spacing used in the specification disucssed in details is based on 27 KHz and reference to the use of higher SCS could not be found
				Up to 1GHz	27.648 MHz	No	
				Support of Multiple different bandwidth values	Yes	YES	For the DECT-NR RIT component – 0.864/1.728/...27.64 MHz bandwidths are specified  For the 3GPP-NR component-: bandwidths of 5/10/... 400Mhz are specified

## 3.2 DETAILED TECHNICAL EVALUATION

This section provides the details of the evaluation and 5GIF findings on the DECT RIT candidate IMT-2020/17 for mMTC and URLLC usage scenario. DECT Forum has provided “ETSI TR 103 514 “Digital Enhanced Cordless Telecommunications (DECT); DECT-2020 New Radio (NR) interface; Study on Physical (PHY) layer” as a reference in Document 5D/1299.

### 3.2.1 ANALYSIS ASPECTS

In this section, analytical based approach is used to determine the technical performance of the technology. The analysis uses closed form expression based on the inputs and description of technical features in the description template as well as the relevant specifications needed to support those technical features.

Technical Performance calculated in this section are:

- User Plane Latency
- Control Plane Latency
- Reliability

#### 3.2.1.1 USER PLANE LATENCY

##### Requirements

According to Report ITU-R M.2410, User Plane (UP) latency is “the one-way time taken to successfully deliver an application layer packet/message from the radio protocol layer 2/3 SDU ingress point to the radio protocol layer 2/3 SDU egress point of the radio interface in either uplink or downlink.”

Table 3.3

Technical performance requirement	Value
Control plane latency for URLLC (ms) For UL & DL	1ms

##### Evaluation Methodology

The proponent should provide the elements and their values in the calculation of the user plane latency, for both UL and DL. The table provides an example of the elements in the calculation of the user plane latency.

The proponent should provide the elements and their values in the calculation of the user plane latency, for both UL and DL. Example of user plane latency analysis template should be **aggregation** of delay due to these components:

- 6) UE Processing Delay
- 7) Frame Alignment
- 8) TTI for data packet transmission
- 9) HARQ Retransmission
- 10) BS Processing Delay

##### Results

Table 3.4 Downlink U-Plane Latency for 27 KHz SCS (Frame Structure : DUDU)

Step	Description ( # OFDM symbol)	Value (ms)
1	Avg symbol alignment time (0.5 OFDM symbol)	<b>0.0208 ms</b>
2	BS pre-processing delay (1 OFDM symbol)	0.0416 ms
3	Frame Alignment(max) (~1 TTI)	<b>0.3592 ms</b>
4	TTI for data packet transmission (1 TTI)	0.416 ms
5	UE pre-processing delay(2 OFDM symbol)	0.0832 ms

HARQ retransmission (6 slots round trip assuming 10% BLER)	0.2496 ms
Total one way UP latency	<b>1.2064 ms</b>

### Evaluation Report

Table 3.5 Result for Downlink U-Plane Latency for 27 KHz SCS (Frame Structure : DUDU)

Required Value	Value
1 ms	1.2064 ms

### 5GIF Observations

Based on self evaluation and study of few papers following observations are made by 5GIF on user plane latency:

- 5GIF has done self evaluation of User Plane Latency in URLLC scenario for DECT RIT candidate taking reference of User Plane Latency calculation in eMBB scenario from component RIT “3GPP NR” as eMBB usage scenario is addressed by the 3GPP NR component. It is noted that DECT Forum does not provide sufficient information on *Symbol Alignment Time* and *Frame Alignment Time*. For the purpose of evaluation reference is taken from 3GPP NR component for these two parameters.

Figure 3.1 See 6.3.2.5 “ETSI TR 103 514 - DECT-2020-NR” URLLC timing

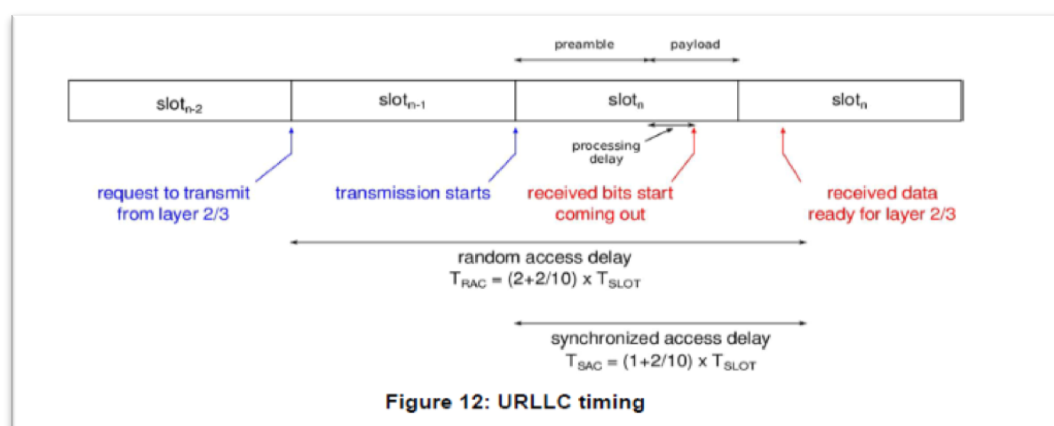

- The technical study (See 6.3.2.5 “ETSI TR 103 514 - DECT-2020 New Radio (NR) interface; Study on Physical (PHY) layer) published by DECT forum has evaluated the latency of **0.917ms** which is even higher than the value (**0.7904**) reported in the self evaluation report (5D/1299) submitted by DECT Forum)

Figure 3.2

#### 6.3.2.5.2.2 Steady-State Low-Latency

In a steady-state regime, where upper layers are in sync with Layer 1, and alternating downlink/uplink packets are single-slot long preamble packets (see Figure 4), a delay of  $(1 + (6+4+2)/10) \times T_{SLOT} \approx 0.917 \text{ ms}$  is achievable. Furthermore, by using short preamble packets or HE packets, more trade-off options are available for data rate vs. reliability.

3. In one of the of DECT Forum whitepaper, it is mentioned that the DECT technology achieves a latency between 2 and 10 ms.  
 (https://www.dect.org/userfiles/file/Press%20releases/DECT%20Today/DECT%20Today%20May%202018.pdf). Embedded below is the screenshot from that paper.

Figure 3.3 Abstract from DECT White Paper

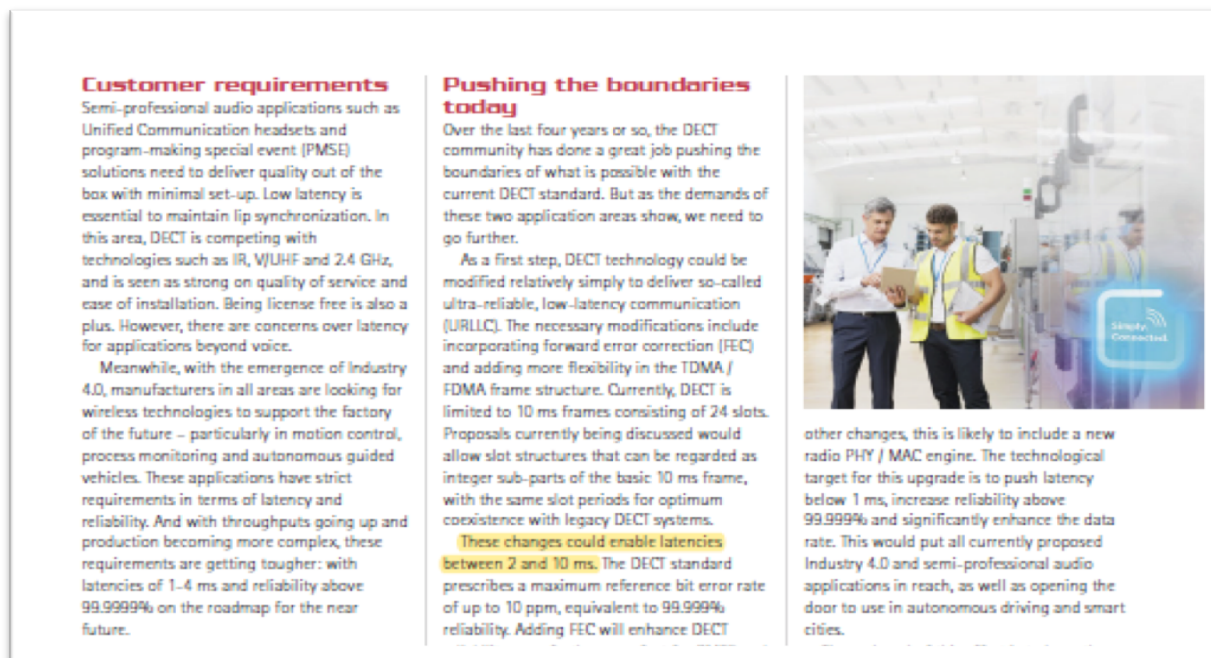

### 3.2.1.2 CONTROL PLANE LATENCY

#### Requirements

According to Report ITU-R M.2410, control plane latency refers to the transition time from a most “battery efficient” state (e.g. Idle state) to the start of continuous data transfer (e.g. Active state). This requirement is defined for the purpose of evaluation in the eMBB and URLLC usage scenarios. The minimum requirement for control plane latency is 20ms.

Table 3.6

Technical performance requirement	Value
Control plane latency for URLLC (ms)	20

#### Evaluation Methodology

The proponent should provide the elements and their values in the calculation of the control plane latency. Example of control plane latency analysis template should be aggregation of latency due to these following components/phases.

- 1) Random access procedure
- 2) UL synchronization
- 3) Connection establishment + HARQ retransmission
- 4) Data bearer establishment + HARQ retransmission

Figure 3.4 Control Plane Flow for NR Rel-15

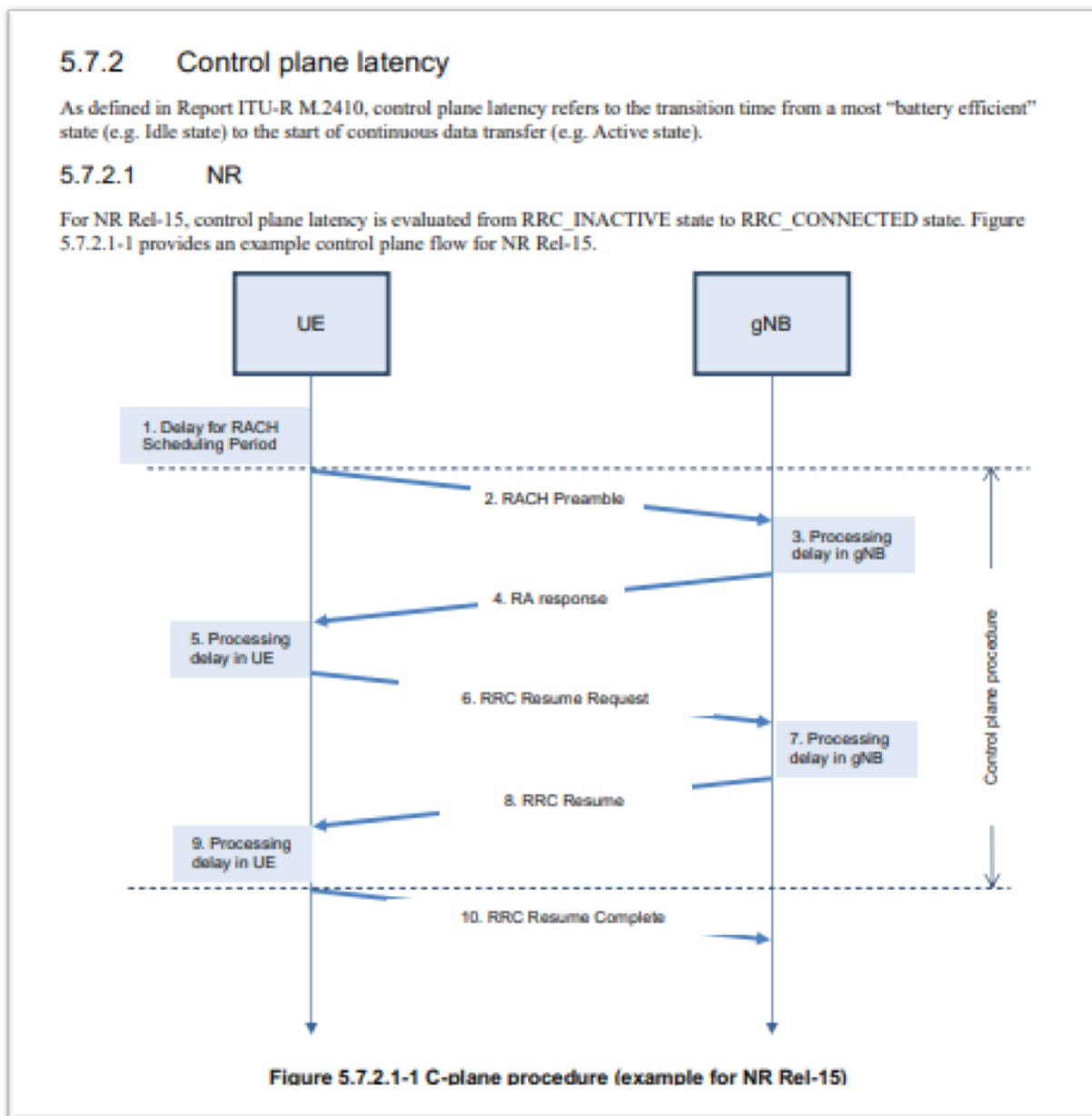

## Results

Table 3.7 Control Plane Latency Calculation for URLLC scenario

Step	Description	CP Latency [ms]	Remarks
1.	Delay due to RACH scheduling period(1TTI)	0	Assumption as per 3GPP NR component evaluation
2.	Transmission of RACH preamble	unknown	<i>Information Missing in their specification</i>
3.	Preamble detection and processing in gNB	unknown	

4	Transmission of RA response	0.4167 (1 TTI)	Assumption as per 3GPP NR component evaluation
5	UE processing delay	5 ms	<i>Reference: Annex B of Compliance template submitted by DECT FORUM in 5D/1299</i>
6	Transmission of RRC resume request	0.4167 (1 TTI)	
7	Association request processing time	1 or 5	
8	Association response TX response	0.4167 (1 TTI)	
9	Association response processing time	1	
	<b>Total</b>	Legacy DECT: >8.2501 DECT-2020: >12.2501	<b>Legacy DECT</b> <i>Essential Overhead related to preamble, RACH etc not provided clearly</i> <b>DECT-2020</b> <i>Essential Overhead related to preamble, RACH etc not found in the specification</i>

## Evaluation Report

Required Value	Value
20 ms	Legacy DECT: >8.2501 DECT-2020: >12.2501

## 5GIF

### Observations

On the basis of self evaluation following observations are made by 5GIF on control plane latency:

- To calculate control plane latency it is necessary to know what PRACH format is used by DECT Forum. Forum has mentioned (Document 5D/1299 P1 - Annex B: Additional Information on URLLC scenario: Sec B.2 ) that Contention Free' RACH Procedure is followed but information on PRACH preamble format is still ambiguous.
- It is noted that DECT Forum in section 6.3.2.2.4 of ETSI TR 103 514 has proposed RAC as a working idea and no further information is provided. That is information of preamble format ,index etc is unclear.

Figure 3.5

<b>6.3.2.2.4</b>	<b>Packet Types for Random Access Channels (RAC) and ULE bearers</b>
<b>6.3.2.2.4.1</b>	<b>General</b>
<p>The use of separate Random Access Channels (RAC) to better protect critical traffic (e.g. URLLC) has been proposed as a working idea that would need to be confirmed in the MAC design phase. The PHY layer study provides packet formats for these bearers.</p>	

### 3.2.2 INSPECTION ASPECTS

This report is the output of Inspection based evaluation of the candidate technology (3GPP NR) for the following Technical Performance Requirements from M.2410. Inspection is conducted by reviewing the functionality and parameterization of a proposal.

#### 3.2.2.1 BANDWIDTH

Bandwidth is the maximum aggregated system bandwidth. The bandwidth may be supported by single or multiple radio frequency (RF) carriers.

##### Requirements

The bandwidth capability of the RIT/SRIT is defined for the purpose of IMT-2020 evaluation.

FR1	At least 100 MHz
FR2	Up to 1 GHz

##### Results

Table 3.8

<b>Maximum Possible Bandwidth using 1024 points FFT(MHz)</b>	<b>Sub Carrier Spacing =27 KHz</b>
	27.648

##### Evaluation Report

Table 3.9

Minimum technical performance requirements item (5.2.4.3.x), units, and Report ITU-R M.2410-0 section reference	Usage scenario	Required value	Value	Requirement?
5.2.4.3.15 Bandwidth and Scalability (4.13)	URLLC	At least 100 MHz	27.648 MHz	No
		Up to 1 GHz	27.648 MHz	No

#### 3.2.2.3 SUPPORTED SPECTRUM BANDS(S)/RANGE(S)

##### Evaluation Methodology

The spectrum band(s) and/or range(s) that the candidate RITs/SRITs can utilize is verified by inspection.

##### Evaluation Report

For the DECT-2020 NR component RIT we have inspected the following:

The candidate RIT is designed to operate over:

- 1) The frequency bands currently allocated to DECT service (1880 MHz – 1900 MHz)
- 2) The frequency bands currently allocated to IMT-2000 FT service (1900 MHz to 1980 MHz and 2010 MHz to 2025 MHz)



The DECT supports operation in 1710-2200 (ITU-R M.1036). There is no other details on support and operation of this technology in other IMT bands.

### 3.2.3 SIMULATION ASPECTS

#### 3.2.3.1 RELIABILITY

As defined in Report ITU-R M.2412(Annex K), reliability is the success probability of transmitting a layer 2/3 packet within a required maximum time, which is the time it takes to deliver a small data packet from the radio protocol layer 2/3 SDU ingress point to the radio protocol layer 2/3 SDU egress point of the radio interface at a certain channel quality.

The minimal requirement defined Report ITU-R M.2410 is  $1-10^{-5}$  success probability of transmitting a layer 2 PDU (protocol data unit) of 32 bytes within 1 ms.

Reliability is evaluated under Urban Macro – URLLC test environment. As defined in Report ITU-R M.2412, the reliability evaluation uses system-level simulation followed by link-level simulation. The evaluation configuration B (carrier frequency = 700 MHz) and channel model A are evaluated for downlink and uplink. The detailed evaluation assumptions for system-level and link-level simulations are provided in table 3.14 and 3.15.

#### Downlink Evaluation Results

In the DECT evaluation, frequency reuse schemes are exploited to mitigate interference and improve the reliability. The following three configurations for frequency reuse factor 1, 3, and 7 are evaluated base on ITU-R WP 5D/1299.

- Case 1: The frequency reuse factor is set to 1. A single DECT-2020 channel with 1.728 MHz bandwidth is applied for URLLC service in each cell, i.e. the system can be considered as a single frequency network.
- Case 2: The frequency reuse factor is set to 3. 3 DECT-2020 channels are applied for URLLC service and the neighboring three BSs use different channels.
- Case 3: The frequency reuse factor is set to 7. 7 DECT-2020 channels are applied for URLLC service and the neighboring seven BSs use different channels.

The network layouts for different frequency reuse factors are provided in Figure 3.2.1.1.1-1 extracted from Report ITU-R WP 5D/1299. In Figure 3.2.1.1.1-1, the interference cell from the wrap-around layout are not marked.

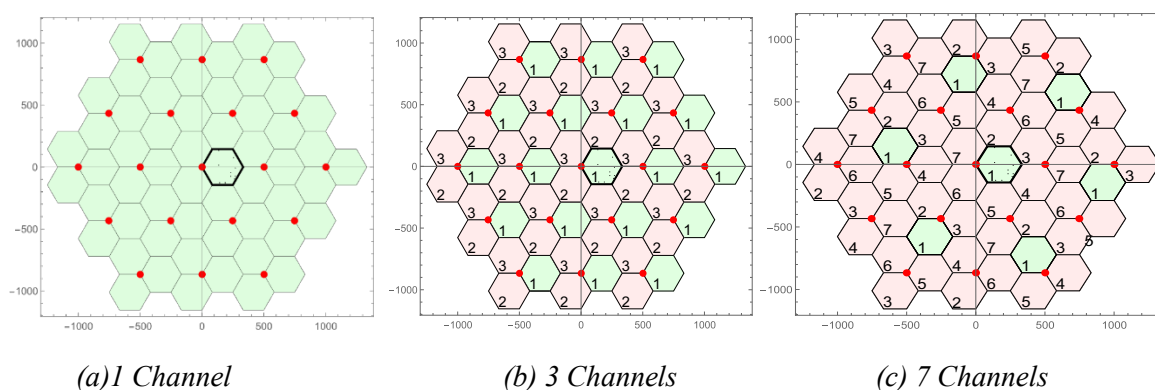

Figure 3.6 Network layout for frequency reuse factors 1, 3, and 7. Green color indicates interfering cell. Number indicates the used channel in a given configuration.

In the system-level simulation, the SINR distributions for different frequency reuse factors provided in Figure 3.7 and the 5%-tile SINR are illustrated in Table 3.10. Pre-processing SINR is used for reliability evaluation, which is defined on an Rx antenna port with respect to a Tx antenna port.

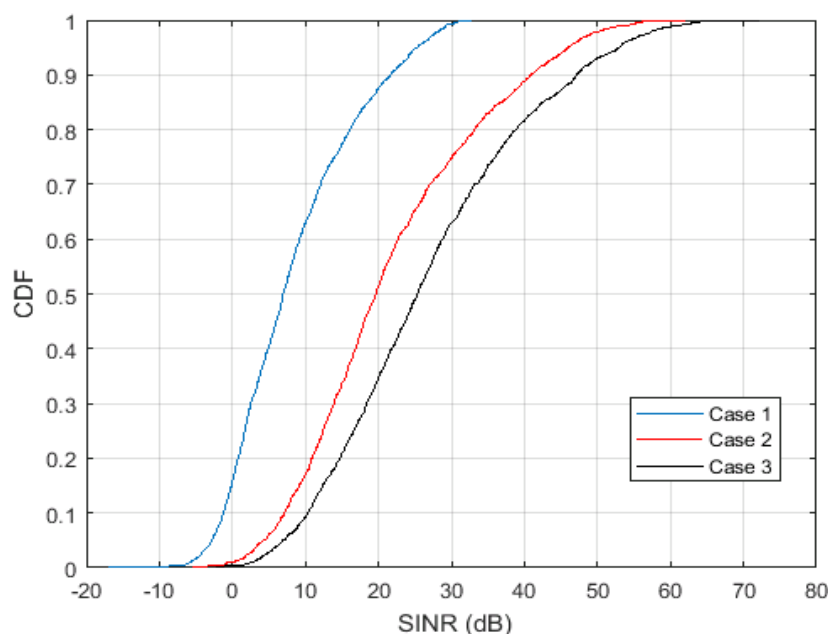

Figure 3.7 Downlink SINR distribution obtained from system level simulation (BS antenna array: 15x4, BS Tx power: 49 dBm)

Table 3.10 5%-ile SINR obtained from system-level simulation for downlink

Configuration	Case 1	Case 2	Case 3
5%-tile SINR (BS Tx power: 49 dBm BS antenna array: 15x4)	-2.8 dB	4.4 dB	6.9 dB

In the link-level simulation, the packet with the size of 37 bytes is carried in one slot over 4 available data filed symbols. And the second level MCS (i.e. QPSK modulation and 3/4 code rate) is used in the evaluation. NLOS channel state is considered. The SNR-BLER curve is illustrated in Figure 3.6

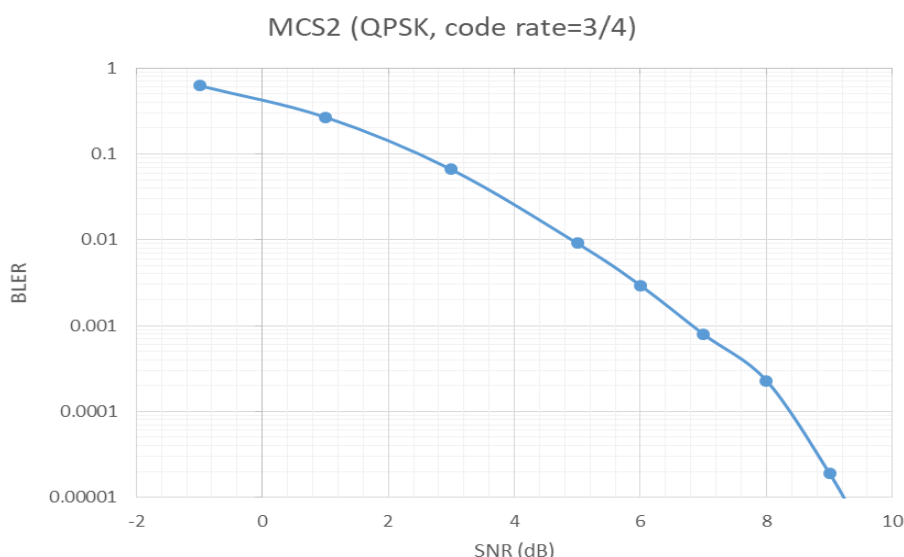

Figure 3.8 SNR-BLER curve for data channel evaluation (BS antenna array: 15x4, BS Tx power: 49 dBm)

Based on the results from Figure 3.7 and Figure 3.8, the downlink reliability is obtained in Table 3.11. It is observed that DECT cannot fulfil the reliability requirement in downlink using the maximum antenna array 15x4

Table 3.11 Evaluation results of downlink reliability

Scheme and antenna configuration	Sub-carrier spacing [kHz]	Channel condition	Frequency reuse scheme	5%-tile SINR [dB]	ITU Requirement	Reliability
SU-MIMO (BS antenna array: 15x4)	27	NLOS	Case 1	-2.8	99.999%	10.9213%
SU-MIMO (BS antenna array: 15x4)	27	NLOS	Case 2	4.4	99.999%	98.3007%
SU-MIMO (BS antenna array: 15x4)	27	NLOS	Case 3	6.9	99.999%	99.9215%

### Uplink Evaluation Results

For uplink reliability evaluation, the frequency reuse schemes are the same as that of downlink. In the system-level simulation, the SINR distributions for different frequency reuse factors are provided in Figure 3.9 and the 5%-tile SINR is illustrated in Table 3.12.

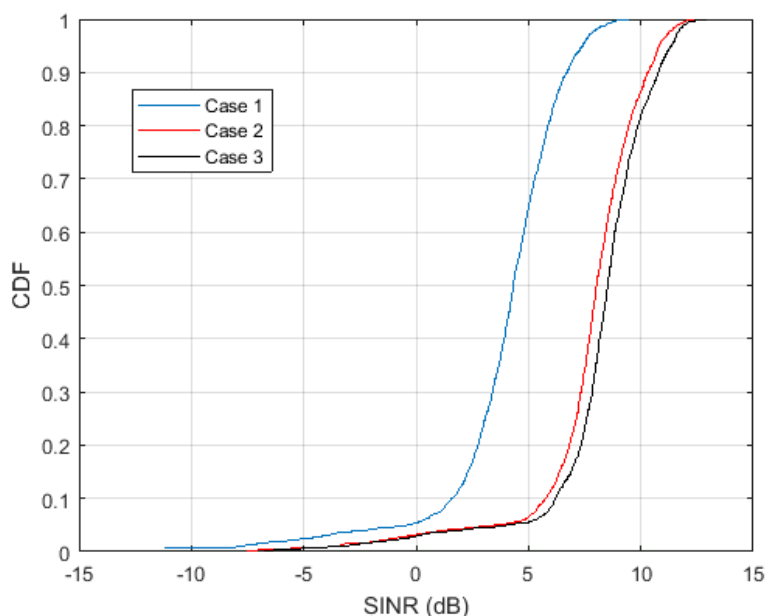

Figure 3.9 Uplink SINR distribution obtained from system level simulation (BS antenna array: 15x4, UE Tx power: 23 dBm)

Table 3.12 5%-tile SINR obtained from system-level simulation for uplink

Configuration	Case 1	Case 2	Case 3
5%-tile SINR (UE Tx power: 23 dBm BS antenna array: 15x4)	-0.4 dB	3.7 dB	4.1 dB

In the link-level simulation, the evaluation assumptions including packet size, MCS level, and channel state are the same as that of downlink. The SNR-BLER curve for uplink data channel is also provided in Figure 3.8. Based on the results from Figure 3.9 and the 5%-tile SINR in Table 3.12, the uplink reliability is obtained in Table 3.13

Table 3.13 Evaluation results of uplink reliability

Scheme and antenna configuration	Sub-carrier spacing [kHz]	Channel condition	Frequency reuse scheme	5%-tile SINR [dB]	ITU Requirement	Reliability
SU-MIMO (BS antenna array: 15x4)	27	NLOS	Case 1	-0.4	99.999%	48.5944%
SU-MIMO (BS antenna array: 15x4)	27	NLOS	Case 2	3.7	99.999%	96.3088%
SU-MIMO (BS antenna array: 15x4)	27	NLOS	Case 3	4.1	99.999%	97.4825%

It is observed that DECT cannot fulfil the reliability requirement in uplink using the maximum antenna array 15x4. Since the DECT cannot fulfil the reliability requirement with the maximum antenna array 15x4, the DECT also cannot fulfil the reliability requirement with the antenna array 5x4.

The assumptions for the system-level simulations (SLS) are given in Table 3.16 and link-level simulations are given in Table 3.17.

Table 3.14 DECT System-level evaluation assumption for DL/UL Reliability

Configuration Parameters	URLLC Configuration B	Reference
Inter-site distance	500 m	DECT Compliance Template
Base station Antenna Height	25 m	DECT Compliance Template
Number of antenna elements per TxRP	Results provided with 60, (15x4) antenna elements	DECT Compliance Template
Number of UE antenna elements	4	DECT Compliance Template
Device deployment	<b>80% outdoor, 20% indoor</b>	M.2412
UE mobility model	Fixed and identical speed $ v $ of all UEs, randomly and uniformly distributed direction	M.2412
UE speeds of Interest	3 km/h for indoor and 30 km/h for outdoor	M.2412
Inter-site interference modelling	Explicitly modelled	M.2412
BS noise figure	5 dB	DECT Compliance Template
UE noise figure	7 dB	DECT Compliance Template
BS antenna element gain	8 dBi	DECT Compliance Template
UE antenna element gain	0 dBi	DECT Compliance Template
Thermal noise level	-174 dBm/Hz	DECT Compliance Template
Traffic model	Full Buffer	DECT Compliance Template
Simulation bandwidth	20 MHz	DECT Compliance Template
UE density	10 UEs per TxRP	DECT Compliance Template
UE antenna height	1.5 m	DECT Compliance Template
Numerology	27 KHz SCS	DECT Compliance Template
Scheduling	PF	Assumption
Receiver	MMSE	Assumption
Channel estimation	Non-ideal	Assumption
Carrier frequency	700 MHz	DECT Compliance Template
TxRP number per site	3	DECT Compliance Template
Wrapping around method	Geographical distance	M.2412
Criteria for evaluation of serving TxRP	RSRP based	Assumption
Mechanical Tilt	90.0 degree	M.2412
Electric Tilt	99.0 degree	Assumption
SLAV	30	M.2412
HBeamwidth	65	M.2412
VBeamwidth	65	M.2412
Horizontal scan	0.0	Assumption
Horizontal spacing between antenna elements	0.5	Assumption
Vertical spacing between antenna elements	0.8	Assumption

Table 3.15 DECT Link-level evaluation assumption for DL/UL Reliability

Configuration Parameters	URLLC Configuration B	Remarks
Evaluated service profiles	Full buffer best effort	DECT Compliance Template
Simulation bandwidth	1.728 MHz	DECT Compliance Template
Number of users in simulation	1	DECT Compliance Template
Packet size	37 bytes at Layer 2 PDU	DECT Compliance Template

Link-level channel model	TDL-iii	
Delay spread scaling parameter	363 ns	
Carrier frequency for evaluation	700 MHz	DECT Compliance Template
Numerology	27 KHz SCS	DECT Compliance Template
Number of antenna elements per TxRP	Results provided with 60,(15x4) antenna elements	DECT Compliance Template
UE antennas	4	DECT Compliance Template
Packet format	Long preamble packet	Assumption
Channel estimation	Non ideal	Assumption
Number of symbol for control information	2	Assumption
Number of symbol for data	4	Assumption
Control information modulation and coding	TBCC with code rate=1/2, QPSK Repetition 2	DECT Compliance Template
Data modulation and coding	Turbo with code rate=3/4, QPSK	DECT Compliance Template

Figure 3.10 shows the Antenna Gains available at different locations in the network layout when one BS is active (considering 3 TRxPs). From the Figure 3.10 it is observed for **DECT** that good antenna gains are obtained not only at locations near BS but the users at far away location are also getting some gains which could add up to give high interference to that particular user from this active base station. The **3GPP** shows good gains in the cell itself with good coverage for near users with negative gains in locations away from the BS.

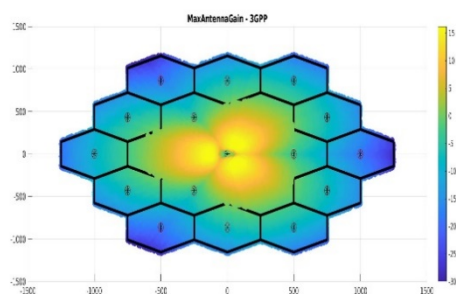

Figure 3.10 Maximum Antenna Gain Possible in a Network Layout for DECT(LEFT) and 3GPP(Right) with one BS Active.

### 3.3 CONCLUSION

5GIF evaluated the candidate technology submission by TC DECT forum - IMT-2020/17, based on the available information provided by the proponent and the observations made by WP5D in IMT-2020/26.

One of the RIT component of the submission was the same as 3GPP NR (IMT2020/14) and hence evaluation done in Chapter 2 applies for this component of this SRIT for meeting the requirements of eMBB usage scenario. TC DECT had submitted and endorsed the self-evaluation report of the 3GPP-NR (IMT-2020/14) in the submission.

The DECT 2020 NR is required to meet the requirements for URLLC and mMTC usage scenarios. We have independently evaluated this component against those requirements.

As per our evaluation, the DECT 2020 NR component does not meet the minimum requirements of reliability, user plane latency for URLLC scenario.

For the minimum performance requirements of mMTC scenario, we were unable to determine if the DECT2020 NR can meet the requirements due to incomplete information in the self-evaluation report for connection density evaluation. Moreover, the specification and description of the working of the DECT2020 is not sufficient to independently evaluate this requirement.

We also noticed missing details in specifications as well as clarity on the assumptions used in the self-evaluation report for the DECT 2020 NR component. Our detailed observations on their submissions are also provided in Section 1.2.

## 4. Assessment of candidate technology – EUHT (IMT-2020/18)

In this chapter, our assessment is based on the information submitted in the revised submission by Nufront after WP5D#32, Bouzios, Brazil. The final submission [5D/1300](#) was discussed during the WP5D#33 meeting. We have used the information available from the Description Templates and specifications submitted by EUHT. Wherever, enough information was not available, we have referred to the assumptions given in their self-evaluation report.

### 4.1 Compliance Templates

This section provides templates for the responses that are needed to assess the compliance of a candidate RIT or SRIT with the minimum requirements of IMT-2020. This assessment is independently done based on the characteristic template and EUHT specifications referred in the submission by the proponents in [IMT2020/18](#).

The compliance templates are based on ITU-R M.2411:

- Compliance template for services.
- Compliance template for spectrum; and,
- Compliance template for technical performance

As per the ITU-R Report M.2411, Section 5.2.4, the summary based on our evaluation is as below:

#### 4.1.1 Services

*(M.2411 - Compliance template for services 5.2.4.1)*

<b>M.2411 Section</b>	<b>Service capability requirements</b>	<b>5GIF comments</b>
<b>5.2.4.1.1</b>	<p><b>Support for wide range of services</b> Is the proposal able to support a range of services across different usage scenarios (eMBB, URLLC, and mMTC)?</p> <p><input type="checkbox"/> YES/ <input checked="" type="checkbox"/> NO</p> <p>Specify which usage scenarios (eMBB, URLLC, and mMTC) the candidate RIT or candidate SRIT can support.</p>	<p>a) The proposal of EUHT component RIT does not support eMBB services.</p> <p><i>Spectral Efficiencies does not meet the minimum requirements.</i></p> <p>b) The proposal of EUHT component RIT does not support URLLC services.</p> <p><i>Reliability does not meet the minimum requirements.</i></p>

#### 4.1.2 Spectrum

*(M.2411 - Compliance template for spectrum - 5.2.4.2)*

	<b>Spectrum capability requirements</b>
<b>5.2.4.2.1</b>	<p><b>Frequency bands identified for IMT</b> Is the proposal able to utilize at least one frequency band identified for IMT in the ITU Radio Regulations?</p> <p><input type="checkbox"/> YES/ <input checked="" type="checkbox"/> NO</p> <p>Specify in which band(s) the candidate RIT or candidate SRIT can be deployed.</p> <p><b>5GIF Observations</b> <i>Unable to determine from the EUHT specifications, the specification does not have any information on the IMT bands. There is one reference to 2.4 GHz band in Table 21, Section 6.3. of the specification which is not an IMT band.</i></p>



<p><b>5.2.4.2.2</b></p>	<p><b>Higher Frequency range/band(s)</b>          Is the proposal able to utilize the higher frequency range/band(s) above 24.25 GHz?:</p> <p><input type="checkbox"/> YES / <input checked="" type="checkbox"/> NO</p> <p>Specify in which band(s) the candidate RIT or candidate SRIT can be deployed.          NOTE 1 – In the case of the candidate SRIT, at least one of the component RITs need to fulfil this requirement.</p> <p><b>5GIF Observations</b>  <i>Unable to determine from the EUHT Specification, if both STA and CAP can communicate using the mmWave band</i>  <i>For e.g. : In the System Information Channel (SICH), the broadcast information (table 55 in Section 8.4.1) has bit patterns only for representing Subcarrier spacing of 19.53125 kHz, 39.0625kHz and 78.125kHz, whereas the table for numerology (Table 38) supports only 390.625kHz for mmWave mode.</i></p>
-------------------------	--

### 4.1.3 Technical Performance

(M.2411 - Compliance template for technical performance from 5.2.4.3)

Minimum technical performance requirements item (5.2.4.3.x), units, and Report ITU-R M.2410-0 section reference <sup>(1)</sup>	Category			Required value	Value <sup>(2)</sup>	Requirement met?	5GIF Comments
	Usage scenario	Test environment	Downlink or uplink				
5.2.4.3.1 Peak data rate (Gbit/s) (4.1)	eMBB	Not applicable	Downlink	20	< 2.177Gbps	NO	<i>Refer Section 4.2.1 (Analysis Aspects)</i>  <i>Peak Data Rate evaluated with peak spectral efficiency considering zero overhead.</i>  <i>Maximum Bandwidth considered is 100MHz normal mode / (mmWave mode, see details in Section 4.2)</i>  <i>Downlink: 2.177Gbps – normal mode</i> <i>2.177 Gbps – mmWave mode</i>  <i>Uplink: 2.177 Gbps – normal mode</i> <i>2.177 Gbps – mmWave mode</i>
			Uplink	10	< 2.177Gbps	NO	
5.2.4.3.2 Peak spectral efficiency (bit/s/Hz) (4.2)	eMBB	Not applicable	Downlink	30	< 21.77	NO	<i>Refer Section 4.2.1 (Analysis Aspects)</i>  <i>We were able to independently evaluate the peak spectral efficiency for ideal zero OH case as:</i> <i>“Normal CP value (Short CP value)”</i>  <i>Downlink &amp; Uplink :</i> <i>For both normal mode mmWave :</i>  <i>Normal CP : 19.6</i> <i>Short CP : 21.77</i>
			Uplink	15	-	-	

							<i>Uplink may not meet the requirement if the OH &gt; 23.46%~31.11%</i>
5.2.4.3.3 User experienced data rate (Mbit/s) (4.3)	eMBB	Dense Urban – eMBB	Downlink	100	25	No	<i>Refer Section 4.2.1 (Analysis Aspects)</i> <i>5<sup>th</sup> percentile user spectral efficiency does not meet the requirement even with maximum supported system bandwidth of 100 MHz.</i> <i>Config A, (4GHz,8T8R)</i>
			Uplink	50	10	No	

<b>5.2.4.3.4</b> 5 <sup>th</sup> percentile user spectral efficiency (bit/s/Hz) (4.4)	eMBB	Indoor Hotspot – eMBB	Downlink	0.30	0.03 ~ 0.24 (Config. A) 0.01 ~ 0.06 (Config. B)	No	<i>Refer Section 4.2.3 (Simulation Aspects)</i> <i>Config A (4G) with 12 TRxP and 36TRxP</i> <i>Config B (30GHz) with 12 TRxP and 36TRxP</i>  <i>Does not meet for either of the configuration A and B</i>
			Uplink	0.21	0.08 ~ 0.18 (Config. A) 0.05 ~ 0.10 (Config. B)	No	
	eMBB	Dense Urban – eMBB	Downlink	0.225	0.22 ~ 0.25 (Config. A) 0.001 (Config. B)	Yes	<i>Refer Section 4.2.3 (Simulation Aspects)</i> <i>Config A (4G) with 12 TRxP and 36TRxP</i> <i>Config B (30GHz) with 12 TRxP and 36TRxP</i>  <i>Does not meet for either of the configuration A and B</i>
			Uplink	0.15	0.08 ~ 0.01 (Config. A) 0 (Config. B)	No	
<b>5.2.4.3.5</b> Average spectral efficiency (bit/s/Hz/ TRxP) (4.5)	eMBB	Indoor Hotspot – eMBB	Downlink	9	4.99	No	<i>Refer Section 4.2.3 (Simulation Aspects)</i>  <i>Indoor Hotspot: Config A (FR1: 4GHz) with 36TRxP</i>
			Uplink	6.75	2.71	No	
	eMBB	Dense Urban – eMBB	Downlink	7.8	7.68	No	<i>Dense Urban: Config A: 4GHz, TDD</i>
			Uplink	5.4	3.58	No	
<b>5.2.4.3.6</b> Area traffic capacity (Mbit/s/m <sup>2</sup> ) (4.6)	eMBB	Indoor-Hotspot – eMBB	Downlink	10	2.994	No	<i>Refer Section 4.2.3 (Analysis Aspects)</i>  <i>Config A (4GHz, TDD): 36TRxP.</i>
<b>5.2.4.3.11</b> Reliability (%) (4.10)	URLLC	Urban Macro – URLLC	Downlink	99.999 %	99.531%	No	<i>Refer Section 4.2.3 (Simulation Aspects)</i>  <i>Config A (4GHz, TDD):</i>

			Uplink	99.999 %	92.37%	No	
<b>5.2.4.3.14</b> Mobility interruption time (ms) (4.12)	eMBB and URLLC	Not applicable	Not applicable	0			See Section 4.2.1 (Analysis Aspects)  It is not clear how the CA based mobility works in case of mobility between source CAP and target CAP.  No CA explained or support in the specification
<b>5.2.4.3.15</b> Bandwidth and Scalability (4.13)	Not applicable	Not applicable	Not applicable	At least 100 MHz	100 MHz and more	Yes	See Section 4.2.2 (Inspection Aspects)
				Up to 1 GHz	1 GHz and more	No	Maximum bandwidth supported is 100MHz for a STA in mmWave mode and normal mode
				Support of multiple different bandwidth values <sup>(4)</sup>	Supported	Yes	See Section 4.2

(1) As defined in Report ITU-R M.2410-0.

(2) According to the evaluation methodology specified in Report ITU-R M.2412-0.

(3) Proponents should report their selected evaluation methodology of the Connection density, the channel model variant used, and evaluation configuration(s) with their exact values (e.g. antenna element number, bandwidth, etc.) per test environment, and could provide other relevant information as well. For details, refer to Report ITU-R M.2412-0, in particular, § 7.1.3 for the evaluation methodologies, § 8.4 for the evaluation configurations per each test environment, and Annex 1 on the channel model variants.

(4) Refer to § 7.3.1 of Report ITU-R M.2412-0.

## 4.2 Detailed Technical Evaluation

EUHT RIT provides terminologies, procedures and definitions as part of specification. Some of which have been summarised below.

- A. UE (as defined in 3GPP NR) - **STA** (station).
- B. BS or eNodeB (as defined in 3GPP) - **CAP** (Central Access Point)
- C. According to the EUHT specification a Channel Switching Information Frame (Section 6.3.4.14 of EUHT Specification) is provided:
  - a. Contains a CAP/STA starting channel number. This field is 8 bits (0-255).
  - b. Table 21(Section 6.3.4.14) of Specification states that channel number 3 for 2.4 GHz is supported and no other band support is mentioned as per the specification.
  - c. Channel Identifier field can support 256 channels as per the specification (Section 6.3.4.19)
- D. We could not find information (e.g., ARFCN number or channel raster) on the supported band for EUHT in their specification. For example, we have TS 38.104 which lists all the operational bands of the 3GPP candidate.
- E. Spatial Streams**
  - a. EUHT specification defines a spatial stream as a data stream that is spatially transmitted in parallel. A spatial-time stream is an encoded stream after space-time coding of the spatial stream (Section 2.8 and 2.9 in EUHT Specification)
  - b. EUHT provides support for upto four spatial streams and upto eight spatial-time stream. The MCS support is only for spatial streams upto four. (Section 8.2.8 and Annex B in EUHT Specification)
  - c. A spatial stream is equivalent to a layer (3GPP NR). Maximum four layers are available in EUHT and have been considered in the evaluation of Peak Spectral Efficiency and Peak Data Rate.
  - d. A unique feature available in EUHT which is not available in other candidate technologies is its support of different MCS for different streams and the mapping.

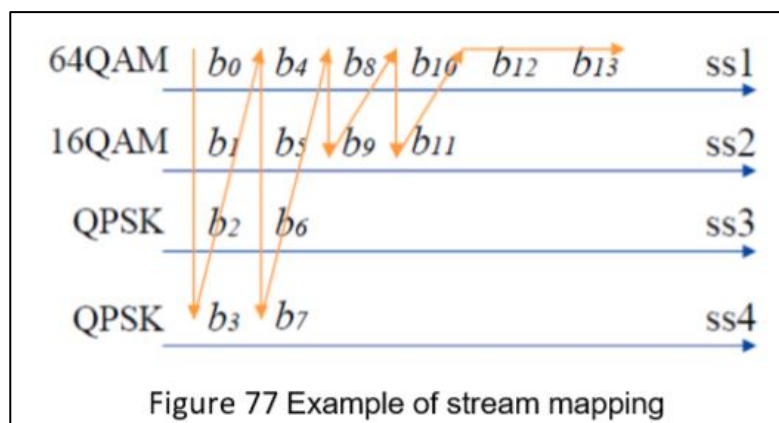

Figure 4.1 Different MCS stream as per specification (8.2.5)

### F. Working Bandwidth Mode

- a. EUHT Submission 5D/1300, provides a STA basic capability request frame which specifies the working bandwidth mode of the STA as given below in Table 4-1. A *working bandwidth mode* specifies a combination of “*working bandwidth*” called as (*working bandwidth-1, working bandwidth-2 and working bandwidth-3*) from which the

STA can choose one mode. Based on this specification, the maximum available bandwidth for a transmission is in the mode number 4 “100 : 25/50/100”, i.e. 100 MHz.

Table 4-1 STA support working bandwidth mode

Working Bandwidth Mode (Bit Representation)	Bandwidths available (MHz)
000	5/10/20
001	10/20/40
010	15/30/60
011	20/40/80
100	25/50/100
Note: If working bandwidth mode is 000, the possible working bandwidths supported by STA are 5/10/20MHz (Section 6.3.4.4 of Specification)	

### G. Sub-Channel

- a. EUHT specification provides multiple bandwidth support by aggregating sub-channels. Each sub-channel is equivalent of carrier component (3GPP NR) which has a bandwidth equal to **working bandwidth-1**
- b. As per the specification  
*“The EUHT system uses **working bandwidth-1** as the basic channel bandwidth, and supports working bandwidth-2 and working bandwidth-3 continuous or discontinuous bandwidths by spectrum aggregation”*

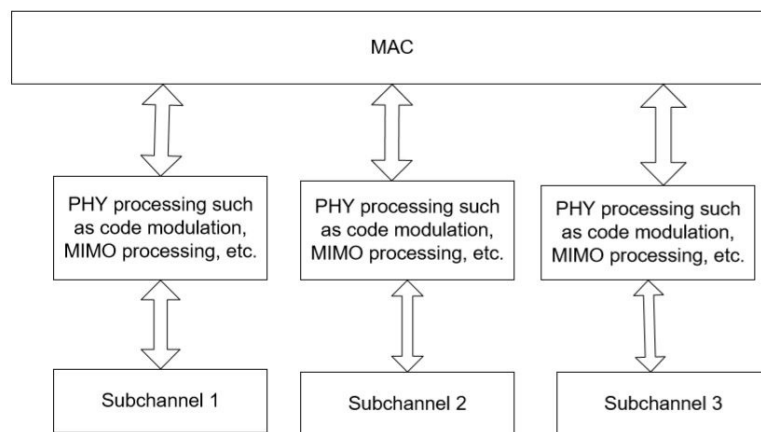

Figure 4.2 Multi-carrier and multichannel working mode of EUHT

- **Spectrum Aggregation Mode (Referring to Specification submitted in WP5D#32, See Attachment in Annex-J.1)**

In the revised submission 5D/1300, included in WP5D#33, these text in the section of the specification was missing.

- c. As per the specification referred:  
*“In spectrum aggregation mode, the STA resides on working bandwidth 1. The CAP can independently schedule 20MHz subchannels to transmit in parallel. A 20MHz STA can only be scheduled on one subchannel in one frame for transmission; a working*

*bandwidth 2 STA can schedule one or two sub-channels in one frame for transmission; an working bandwidth 3 STA can schedule one or 2 or 3 or 4 sub-channels in one frame for transmission.”*

- d. 4 sub-channels aggregated to obtain an effective usage bandwidth equal to “working bandwidth mode”.
- e. The information regarding SCS, system bandwidth available in spectrum aggregation mode (Table 69 in Section 8.11.2.1) is presented in Table 1-1
- f. As per the latest available specification, the information provided above is missing in Section 8.11.

Table 4-2 Spectrum aggregation mode (Section 8.11 of EUHT specification)

Table 69 Spectrum aggregation mode

System bandwidth	20MHz	40MHz	80MHz
Subcarrier interval in frequency domain	78.125 KHz	78.125 KHz	78.125 KHz
Baseband sampling clock	20MHz	40MHz	80MHz

Nufront (Beijing) Technology Group Co., Ltd.

135

新岸线  
NUFRONT

FFT sample points	256	512	1024
Cyclic Prefix sample points	32	64	128
Number of data subcarriers	224	448	896
Number of phase tracking pilot subcarriers	6	12	24
Number of virtual subcarriers	26	52	104
FFT time window	12.8µs	12.8µs	12.8µs
Cyclic Prefix	1.6µs	1.6µs	1.6µs
OFDM symbol period	14.4µs	14.4µs	14.4µs

Providing an example of the working bandwidth mode, sub-channel and spectrum aggregation usage below:

If the supported **working bandwidth mode** is reported to be four (bit-pattern :100) by the STA, the STA can choose one of the three working **bandwidth** from 25/50/100 MHz (refer Table 4A). If the STA chooses to use the **working bandwidth-3 (100MHz)**, the CAP will make use of all the four **sub-channel** each of bandwidth equal to that of **working bandwidth-1**(i.e. 25 MHz).

**5GIF Observation:**

- a) Multiple bandwidth support is obtained by using four sub-channels where the possible sub-channel bandwidths are 5,10,15,20,25 MHz(Table 4A).
- b) Only 256 channels in the 2.4 GHz band can be utilized.(Point C of Section 4.2)
- c) Spectrum Aggregation Mode cannot be used in *mmWave* mode due to lack of support in specification for SCS=390.625 needed for *mmWave* (see Table 4C & Table 4B).
- d) Maximum System Bandwidth in Spectrum Aggregation mode is 80 MHz(Table 4B).
- e) Maximum Bandwidth supported by STA is 100 MHz(Table 4A).
- f) There is also inconsistency regarding bandwidths mentioned as 200MHz, 400MHz but no specification to support by STA (UE)



## Working Modes

The EUHT transmission is TDD with frame numerology corresponding to three working modes: normal mode, low-error mode and *mmWave* mode. Both *normal* mode and *low-error* mode are used for sub 6GHz band, in which the low-error mode is used to achieve high reliability. *mmWave* mode is referred to millimetre wave band (above 24GHz, etc.).

Table 4-3 Working Modes

Working Mode	SCS supported (kHz)	Cyclic Prefix Supported(μs)
Normal Mode	78.125	Short /Normal CP
Low-Error Mode	78.125	Normal CP
mmWave Mode	390.625	Short/Normal CP
Spectrum Aggregation Mode	78.125	Short CP
Note: 19.53, 39.0625 kHz SCS are optional for Normal and Low-Error Mode.		

## Frame Structure

As per the information provided in the Description template and the EUHT specifications, EUHT transmits multiple physical layer frames, each frame has multiple OFDM symbols. The frame is self-contained for broadcast, downlink, uplink control channels and data among those symbols. As per the specification variable symbol durations are supported that depends on sub-carrier spacing, bandwidth and guard interval. Smallest allocation of one-symbol is possible, which also will be accompanied with other UL/DL Control channels and preambles.

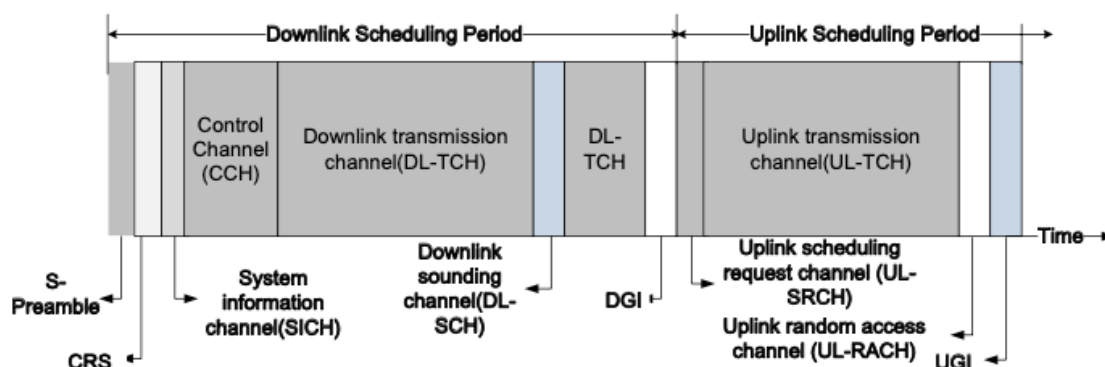

Figure 4.3 EUHT Frame Structure

EUHT specifications and Description template mention that the frame length can be dynamically adjusted within the allowable range(0.1-14ms).The specification does not account for the methodology used for dynamic frame length adjustment and CAP time synchronisation which is an essential component for the use of variable frame length without which frame length cannot be adjusted.

EUHT candidate self-evaluation report and simulation use only 78.125kHz SCS. The numerology for the same is provided in the Table 4-4:

Table 4-4 Numerology

Parameter	78.125 kHz
System bandwidth	5/10/15/20/25/30/40/50/60/80/100

Supported (MHz)	
Cyclic Prefix(μs)	1.6 (Short CP), 3.2 (Normal CP)
OFDM symbol period(μs)	14.4 (Short CP), 16 (Normal CP)

EUHT specification mentions support for BPSK, QPSK, 16-QAM, 64-QAM, 256-QAM, 1024-QAM but it has been observed that the STA can mention support for only upto 256-QAM in the STA Basic Capability Request Frame (Table 7 in Section 6.3.4.4).

### Comparison of EUHT with similar technologies

5GIF also observed a few similarities with IEEE 802.11ax –

(802.11ax is a standard meant for < 6GHz) which are shown in the Table 4-5–

*Table 4-5 Similarities*

Parameter	Similarity
Subcarrier Spacing of	78.125 kHz <sup>11</sup>
OFDM Symbol duration (GI + Duration)	(14.4μSec + 16μSec) <sup>1</sup>
FEC – BCC & LDPC	LDPC <sup>12</sup>
Max MIMO Layers (Spatial Time Streams) <sup>13</sup>	8
Sub-channel / spectrum aggregation <sup>14</sup>	sub-channels
RU Size	16 Subcarrier into one RU

## 4.2.1 Analysis Aspects

### 4.2.1.1 Peak Spectral Efficiency

#### Requirements

Performance Measure	ITU Requirements
---------------------	------------------

<sup>1</sup> K. Chen, D. Deng and S. Lien and J. Lee. On Quality-of-Service Provisioning in IEEE 802.11ax WLANs. IEEE Access,6086-6104.

<sup>2</sup> Hoefel, R. P. F. (2018, July). IEEE 802.11 ax: On Performance of Multi-Antenna Technologies with LDPC Codes. In *2018 IEEE Seventh International Conference on Communications and Electronics (ICCE)* (pp. 159-164). IEEE.

<sup>3</sup> Hoefel, R. P. F. IEEE 802.11 ax: On Time Synchronization in Asynchronous OFDM Uplink Multi-User MIMO Physical Layer.

<sup>4</sup> Deng, Der-Jiunn and Chen, Kwang-Cheng and Cheng, Rung-Shiang. IEEE 802.11 ax: Next generation wireless local area networks. 10Th international conference on heterogeneous networking for quality, reliability, security and robustness. Publisher IEEE.

Peak Spectral Efficiency	DL: 30 bps/Hz UL: 15 bps/Hz
--------------------------	--------------------------------

Section 4.2 of ITU-R M.2410 states that these values were defined assuming an antenna configuration to enable eight spatial layers (streams) in the downlink and four spatial layers (streams) in the uplink. Proponents must demonstrate that the peak spectral efficiency requirement can be met for, at least, one of the carrier frequencies assumed in the test environments under the eMBB usage scenario.

### Evaluation Methodology

Refer to section 7.2.1 of M.2412

### Results

The EUHT candidate supports different channel bandwidth for normal mode and mmWave mode as given in the Table 4F and 4G. The below given formula is used to calculate Peak Spectral Efficiency ( $SE_{peak}$ ) for a specific component carrier

$$SE_p^{(i)} = \frac{v_{Layer}^{(i)} \cdot Q_m^{(i)} \cdot R_{max} \cdot \frac{N_{SD}^{BW(i),\rho(i)}}{T_{Link}^{\rho(i)}} \cdot (1 - OH^{(i)})}{BW^{(i)}} \quad (1)$$

wherein

- $R_{max}$  is the maximum code rate of LDPC
- For the  $i$ -th CC,  $v_{Layer}^{(i)}$  is the maximum number of layers
- $Q_m^{(i)}$  is the maximum modulation order
- $\rho^{(i)}$  is the Frame length
- $T_{Link}^{\rho(i)}$  is the duration of Downlink/Uplink in a frame (type  $\rho^{(i)}$ )
- $N_{SD}^{BW(i),\rho(i)}$  is the number of subcarriers allocation in bandwidth  $BW^{(i)}$  with Frame length  $\rho^{(i)}$ , where  $BW^{(i)}$  is the STA supported maximum bandwidth in the given band or band combination
- $OH^{(i)}$  is the overhead calculated as the average ratio of the number of OFDMs or subcarriers occupied by L1/L2 control, synchronization signal, sounding signal, demodulation reference signal and guard period, etc.
- For guard period (GP), 50% of GP symbols are considered as downlink overhead, and 50% of GP symbols are considered as uplink overhead.
- $r_{DL}$  - ratio of DL to total symbols.

Using the tables 35-39 from the specifications, the number of subcarriers for a given supported Bandwidth ( $N_{sd}$ ) for the possible Subcarrier Spacing(SCS) have been provided in the Table 4-6 and Table 4-7.

Table 4-6 Normal Mode(Sub-6GHz band)

(a) CS (kHz)	(b) (c) Hz	(d) 0 (e) Hz	(f) 5 (g) Hz	(h) 0 (i) Hz	(j) 5 (k) Hz	(l) 0 (m) Hz	(n) 0 (o) Hz	(p) 0 (q) Hz	(r) 0 (s) Hz	(t) 0 MHz	(u) 00 MHz
	(v) SD	(w) SD	(x) SD	(y) SD	(z) SD	(aa) SD	(bb) SD	(cc) SD	(dd) SD	(ee) SD	(ff) SD
19.53125	224	448	672	896	1120	1344	1792	2240	N/A	N/A	N/A
39.0625	112	224	336	448	560	672	896	1120	1344	1792	2240
78.125	56	112	168	224	280	336	448	560	672	896	1120

Table 4-7 mmWave band

(gg) SCS [kHz]	(hh) 50 MHz	(ii) 100 MHz
	(jj) N <sub>SD</sub>	(kk) N <sub>SD</sub>
390.625	112	224
NOTE: As per Section 6.3.4.4 Table 7 of specification, maximum bandwidth supported by STA is 100MHz		

### Downlink

The number of layers considered as per SER are eight and six for normal mode and mmWave mode but there is a maximum support of only four spatial streams which is equivalent to the number of layers (Refer to section 4.2 – Spatial streams). Depending on the parameters as defined in Table 4-8 the calculated DL SE<sub>peak</sub> is given Table 4-10.

Table 4-8 Technical Parameters used for DL (rDL = 0.5, DL: UL=1:1)

Parameter	Value		Remark
	Normal mode	mmWave mode	
V <sub>Layer</sub> (see Note)	4	4	From SP
Q <sub>m</sub> (256 QAM)	8	8	
R <sub>max</sub>	0.875	0.875	
ρ <sup>(i)</sup> (ms), (Frame Duration)	2	20	
N <sub>SD</sub> <sup>BW(i),ρ(i)</sup>	224	224	
BW <sup>(i)</sup> (MHz)	20	100	
SCS (kHz)	78.125	390.625	
Note: There is only 256- QAM STA capability from table 7, section 6.3.4.4 of the SPEC The number of layers is considered as per the section 4.2 – Spatial streams. DT= Description Template, SP = Specification, SER- Self. Eval. Report in 5D/1300			

The SE<sub>peak</sub> considers symbol duration time as per equation (1), in the SER of EUHT the symbol duration considered is with Short CP. Here we consider both Short and Normal CP in the symbol time given in Table 4I for SE<sub>peak</sub> calculations as given in the EUHT Specification (Section 8.2)

Table 4-9 Cyclic Prefix values

	Short Cyclic Prefix	Normal Cyclic Prefix
--	---------------------	----------------------

$T_{Link}^{\rho(i)}$ (us)	<b>Normal mode</b>	14.4	16
	<b>mmWave mode</b>	2.88	3.2

Table 4-10 Peak Spectral Efficiency DL

Parameter		Formula	Value	
			Normal mode	mmWave mode
Peak Spectral Efficiency, $SE_{peak}$ (without OH)	Normal CP	$\frac{v_{Layer}^{(i)} \times Q_m^{(i)} \times Rmax \times \frac{N_{SD}^{BW(i),\rho(i)}}{T_{Link}^{\rho(i)}}}{BW^{(i)}}$	19.6	19.6
	Short CP		21.777	21.777

### Uplink

The number of layers considered as per SER are eight and four for normal mode and mmWave mode but there is a maximum support of only four spatial streams which is equivalent to the number of layers (Refer to section 4.2 – Spatial streams). Depending on the parameters as defined in Table 4-11 the calculated UL  $SE_{peak}$  is given in Table 4-12.

Table 4-11 Technical Parameters used for UL ( $ruL = 0.5$ ,  $DL:UL=1:1$ )

Parameter	Value		Remark
	Normal mode	mmWave mode	
$V_{Layer}$ (see Note)	4	4	From SP
$Q_m$ (256 QAM)	8	8	
$R_{max}$	0.875	0.875	
$\rho^{(i)}$ (ms), (Frame Duration)	2	20	
$N_{SD}^{BW(i),\rho(i)}$	224	224	
$BW^{(i)}$ (MHz)	20	100	
SCS (kHz)	78.125	390.625	
<b>Note:</b> Table 7 of section 6.3.4.4 in the EUHT specification shows the support of only 256 QAM for STA. The number of layers are considered as per the section 4.2 – Spatial streams. DT= Description Template, SP = Specification, SER- Self. Eval. Report in 5D/1300			

Table 4-12 Peak Spectral Efficiency UL

Parameter		Formula	Value	
			Normal mode	mmWave mode
Peak Spectral	Normal CP	$\frac{v_{Layer}^{(i)} \times Q_m^{(i)} \times Rmax \times \frac{N_{SD}^{BW(i),\rho(i)}}{T_{Link}^{\rho(i)}}}{BW^{(i)}}$	19.6	19.6

Efficiency, $SE_{peak}$ (without OH)	Short CP		21.777	21.777
Max % of OH to meet requirement	Normal CP	$15 = SE_p \times (1 - UL\_OH_{max})$ $UL\_OH_{max} = 1 - 15 / (SE_p)$	23.46%	23.46%
	Short CP		31.11%	31.11%

**DL OH margin** – As depicted in the (Frame structure), each frame has uplink and downlink OFDM symbols. During the portion of downlink transmission, the data channel **DL-SCH** is time multiplexed. As per the M.2412, the peak spectral efficiency should account for the OH duration. To meet the target requirement of peak spectral efficiency, the OH symbols will be limited by the minimum Peak Spectral Efficiency requirements.

Table 4-13 Maximum Downlink OH%

Parameter	CP type	Normal mode	mmWave mode
Max % of DL_OH to meet requirement	Normal CP	Does not meet the requirement	
	Short CP		

**UL OH margin** – As depicted in the Figure 4-3(Frame structure), each frame has uplink and downlink OFDM symbols. During the portion of uplink transmission, the data channel **UL-SCH** is time multiplexed. As per the M.2412, the peak spectral efficiency should account for the OH duration. To meet the target requirement of peak spectral efficiency, the OH symbols will be limited by the minimum Peak Spectral Efficiency requirements.

Table 4-14 Maximum Uplink OH%

Parameter	CP type	Normal mode	mmWave mode
Max % of UL_OH to meet requirement	Normal CP	23.46%	23.46%
	Short CP	31.11%	31.11%

## Summary

Performance Measure	ITU Requirements	Comments
Peak Spectral Efficiency	DL: 30 bps/Hz UL: 15 bps/Hz	<p>The evaluation was performed for idea zero OH Peak Spectral Efficiency due to gaps in the OH calculations.</p> <p>The <math>SE_{peak}</math> values were calculated for both normal and short CP where the requirements was not met in case of DL(mmWave mode) with normal CP.</p> <p>The maximum overhead percentages were calculated for both DL and UL.</p>

**5GIF Observations**

- 1) To meet the  $SE_{peak}$  requirements the overhead requirements need to be within limits – 23.46% in case of UL normal mode, 31.1% in UL NFR2.
- 2) It does not meet the DL Spectral Efficiency value in NFR2 even without overhead.
- 3) The  $SE_{peak}$  is independent of any bandwidth configuration as listed in Table 4F and 4G. The DL and UL  $SE_{peak}$  is also limited by the supported modulation index of the STA which is 256-QAM as given in Specification.
- 4) The control channel is Time Duplexed and would span the entire symbol duration , even if length of control channel is less than number of data subcarrier, before any downlink or uplink transmission in a frame
- 5) As per the IMT-2020/27, observation regarding inconsistency of Downlink & Uplink Guard interval (GI) in specification with the Self-evaluation was noted.  
5GIF found that the referred bit pattern by proponent “b63b62...b57 in table 55” does not address the inconsistency.
  - H. As per the specifications, the bit b63b62...b57 in table 55 only indicates the start of the OFDM symbol for DGI and UGI.
  - I. 5GIF found that the number of symbols for DGI and UGI are still 2symbols for each GI and should be used this for OH calculation.

**4.2.1.2 Peak data rate**

**Requirements**

The minimum requirements for peak data rate are as follows:

Performance Measure	ITU Requirements
Peak data rate	DL: 20 Gb/s UL: 10 Gb/s

NOTE: Peak Data Rate = Aggregated Bandwidth ×  $SE_{peak}$

Peak Data Rate is the maximum achievable data rate under ideal conditions.

For Peak Data Rate the maximum possible bandwidth for each band is provided in table 4O:

**Table 4O Maximum Bandwidth**

	Normal mode	mmWave mode
Maximum Bandwidth supported(MHz)	100	100
Note: Refer to section 4.2 – Working Bandwidth Mode and Spectrum Aggregation Mode.		

Maximum Bandwidth available to schedule to single user is limited by STA capability. (See Table 7 section 6.3.4.4 from EUHT specification)

Table 4-15 shows peak data rate values calculated for maximum bandwidth of 100 MHz (for both Normal mode and mmWave mode).

Table 4-15 Peak Data Rate

Parameter		Formula	ITU Requirement	Value	
				Normal Mode	mmWave Mode
Peak Data Rate (Gbps)	Downlink	Maximum Bandwidth × SE <sub>peak</sub>	20	2.1777	2.1777
	Uplink		10	2.1777	2.1777
Note: The SE <sub>peak</sub> values are calculated with zero OH considerations.					

From Table 4-15, the peak data rate values for normal mode and mmWave mode do not meet the minimum ITU-R requirements.

#### 5GIF Observation

- The maximum bandwidth possible is limited to 100 MHz in normal and mmWave mode as per specifications for working bandwidth modes
- Carrier Aggregation can be done only with a SCS of 78.125 kHz to get a maximum aggregated bandwidth 80 MHz by using sub-channels. This mechanism is used in normal mode to get the supported working bandwidth.
- If the specifications enabled STA to support *working bandwidth mode* for 400 MHz, the peak data rate values would still be **8.708Gbps** for both downlink and uplink, which still do **NOT** meet the minimum ITU-R requirements.

#### 4.2.1.3 User experienced data rate

#### Requirements

The system performance in terms of user-experienced data-rate is to be evaluated in the DU geographic environment. The target values are set as

Performance Measure	ITU Requirements
User Experienced Data rate	DL: 100 Mbps UL: 50 Mbps

#### Evaluation Methodology

Refer to Section 7.2.3 of ITU-R M.2412

$$R_{user} = W \times SE_{user} \quad (1)$$

#### Results

User Experienced Data Rate has been evaluated for the Dense Urban eMBB test environment for configuration A (4GHz). Table 4-16 shows the 5<sup>th</sup> percentile user spectral efficiency results for Dense Urban environment.





Table 4-16 5th percentile user spectral efficiency

Scheme and antenna configuration		Sub-carrier spacing (kHz)	5 <sup>th</sup> -tile [bit/s/Hz]
			Channel Model A BW=20 MHz
8T,(8,4,2,1,1; 1,4) 8R,(1,4,2,1,1; 1,4) MU-MIMO	DL	78.125	0.25
	UL		0.1

The  $SE_{user}$  values from Table 4-16 are used to calculate the User Experienced Data Rate as given in Table 4-17

Table 4-17 User Experienced Data Rate for 20MHz bandwidth

Parameter		Calculation	$R_{user}$ [Mbps]
			Channel model A BW=100MHz
User Experienced Data Rate, $R_{user}$	DL	$100 \times 10^6 \times 0.25$	25 Mbps
	UL	$100 \times 10^6 \times 0.1$	10 Mbps

## Evaluation Report

Scenario	Performance Measure	ITU Requirements	5GIF Results	Conclusion Meets Requirement (Yes/No)	Remarks
			Eval. A		
Dense Urban	User experienced data rate	DL: 100 Mbps	DL: 25 Mbps	No	Spectral Efficiencies do not meet minimum requirements. Maximum Bandwidth support is 100 MHz due to STA bandwidth support limitation.
		UL: 50 Mbps	UL: 10 Mbps	No	

### 5GIF Observations

- The 5<sup>th</sup> percentile user spectral efficiency does not meet the ITU requirement
- Specification support for carrier aggregation is not adequate, the spectrum aggregation mode support aggregation of four sub-channel each with bandwidth equal to 20 MHz to get a maximum aggregated system bandwidth of 100 MHz (From section 4.2 Spectrum Aggregation Mode).

#### 4.2.1.4 Area traffic capacity

##### Requirements

The target value for Area traffic capacity in downlink is 10 Mbit/s/m<sup>2</sup> in the Indoor Hotspot – eMBB test environment.

##### Results

Area Traffic Capacity has been evaluated in Indoor Hotspot eMBB test environment using config A based on the Average spectral efficiency evaluation in Section 4.2.3 .

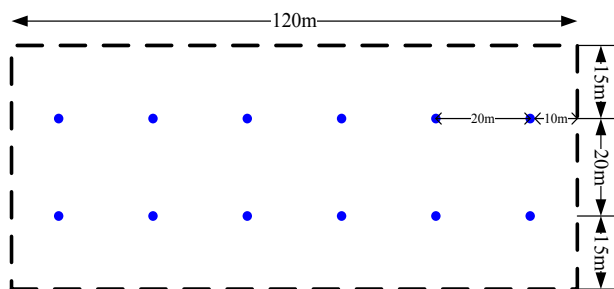

Figure 4.4 Indoor Hotspot sites layout

Based on the Indoor Hotspot network layout as defined in Report ITU-R M.2412, the **TRxP density** is given as follows:

$$\rho = \frac{\text{Number of TRxP}}{\text{Total Area of the network layout}} \text{ (TRxP/m}^2\text{)}$$

	<b>36 TRxP</b>
$\rho$ (TRxP/m <sup>2</sup> )	0.006

where the total area of the network layout is 120×50=6,000m<sup>2</sup>.

Table 4-18 Area traffic Capacity

System bandwidth W(MHz)	DL Average spectral efficiency $SE_{avg}$ [bps/Hz/TRxP]	36TRxP (TRxP density $\rho=0.006\text{TRxP/m}^2$ )
		TDD 100 MHz bandwidth per Carrier Component (CC) with 78.125 kHz SCS
100	4.99	(100×4.99×0.006) = 2.994
Note: Maximum bandwidth supported by STA is 100 MHz..		

## Evaluation Report

Performance Measure	ITU Requirements	5GIF Results	Conclusion Meets Requirement (Yes/No)	Remarks
Area traffic capacity	10 Mbps/m <sup>2</sup>	2.994 Mbps/m <sup>2</sup>	No	Maximum Bandwidth supported 100 MHz. Minimum spectral efficiency requirements not met.

### 4.2.1.5 Mobility Interruption Time

#### Requirements

For seamless transition, 0 ms mobility interruption time is an essential requirement.

Performance Measure	ITU Requirements
Mobility Interruption time	0ms

#### Evaluation Methodology

Refer Section 7.2.7 of ITU-R M.2412

#### Results

As defined in Report ITU-R M.2410, mobility interruption time is the shortest time duration supported by the system during which a UE/STA cannot exchange user plane packets with any BS/CAP during mobility transitions.

The mobility interruption time includes the time required to execute any radio access network procedure, radio resource control signalling protocol, or other message exchanges between the UE/STA and BS/CAP, as applicable to the candidate RIT/SRIT.

*There are some properties support 0ms interrupt time in EUHT, such as:*

1. *The mode of multiple access is OFDMA in EUHT, thus can realize the carrier aggregation (CA) function, and STA could connect with source CAP and target CAP.*
2. *RACH – less is used in EUHT, interaction between source CAP and target CAP could save the time when RACH process occurs.*

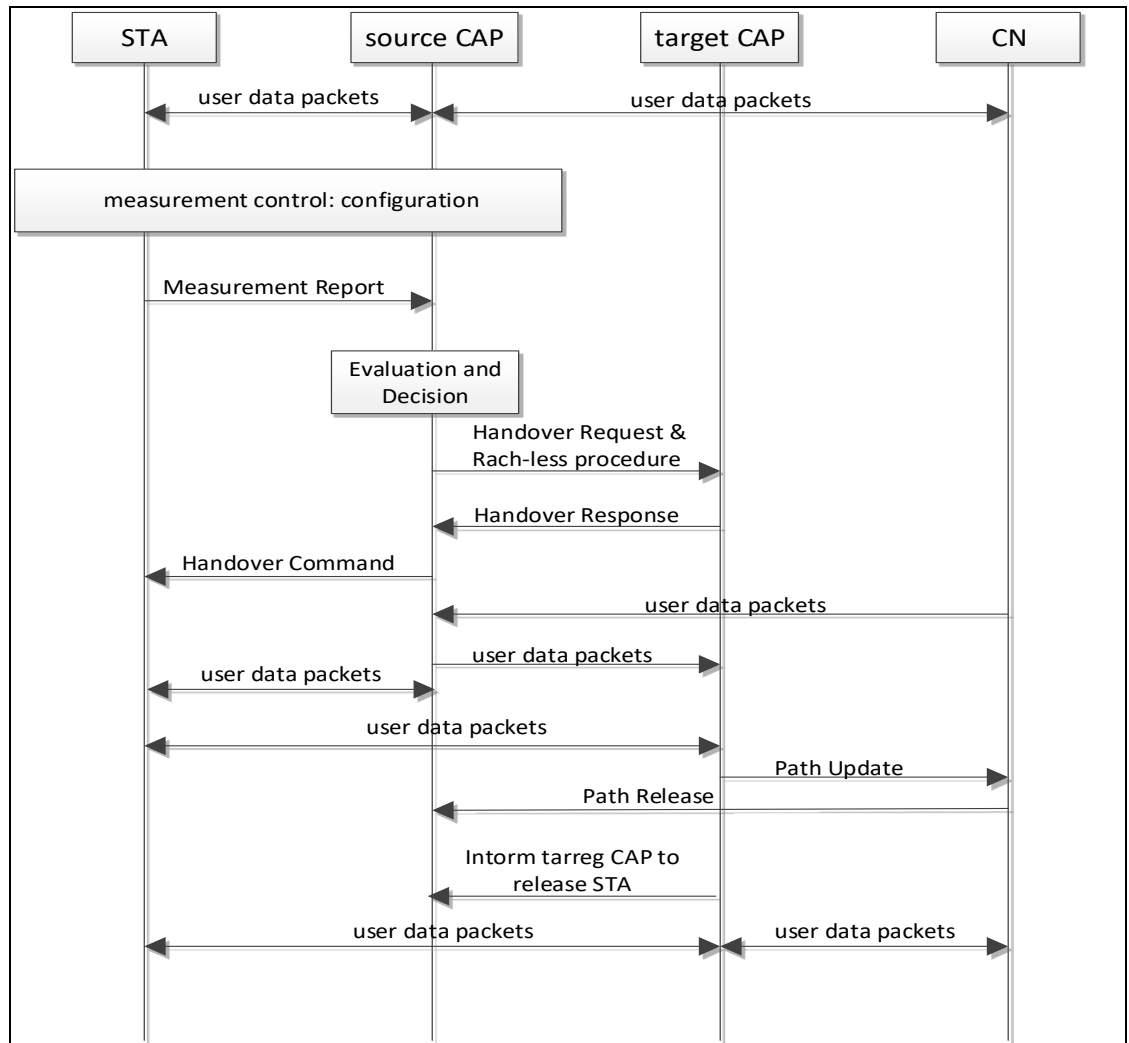

Figure 4.5 0ms interrupt time procedure in EUHT

**5GIF Observations**

Regarding - “The mode of multiple access is OFDMA in EUHT, thus can realize the carrier aggregation (CA) function, and STA could connect with source CAP and target CAP.”

- The CA can only be used for the SCell change without PCell change but not for the PCell change. It is not clear how the CA based mobility works in case of mobility between source CAP and target CAP (in 3GPP, a common MAC entity is assumed for the CA operation), no detail description can be found in the EUHT\_specification’s Section 8.11 “Spectrum aggregation mode”.

## 4.2.2 Inspection Aspects

### 4.2.2.1 Bandwidth

Bandwidth is the maximum aggregated system bandwidth. The bandwidth may be supported by single or multiple radio frequency (RF) carriers.

#### Requirements

Performance Measure	ITU Requirements	
	Normal mode	mmWave mode
Bandwidth	100 MHz	1 GHz

#### Evaluation Methodology

Refer to Section 7.3.1 of ITU-R M.2412

#### Result

It has been observed that EUHT does not support carrier aggregation and bandwidths greater than 100MHz (Refer to section 4.2- Spectrum Aggregation Mode)

Table 4-19 Bandwidth

SCS [kHz] (Frequency Range)	Maximum bandwidth for one component carrier (MHz)	Maximum number of component carriers for carrier aggregation	Maximum aggregated bandwidth (MHz)	Minimum Requirement as per ITU-R M.2410-0	Requirement Met ?
78.125 (Normal mode, <6GHz)	100	1	100	100MHz	YES
390.625 (mmWave mode, > 24GHz)	100	1	100	> 1GHz	NO <i>STA does not support more than 100 MHz bandwidth and carrier aggregation (from section 4.2-spectrum)</i>

					aggregation mode)
--	--	--	--	--	-------------------

### 5GIF Observations

Due to lack of specification for carrier aggregation and STA bandwidth support in mmWave mode, EUHT does not meet the ITU-R bandwidth requirements of upto 1 GHz aggregated bandwidth.

## 4.2.3 Simulation Aspects

### 4.2.3.1 SPECTRAL EFFICIENCY

#### Requirements

eMBB Test Environment	5th percentile user spectral efficiency		Average spectral efficiency	
	DL (bit/s/Hz)	UL (bit/s/Hz)	DL (bit/s/Hz)	UL (bit/s/Hz)
Indoor Hotspot	0.3	0.21	9	6.75
Dense Urban – eMBB	0.225	0.15	7.8	5.4
Rural – eMBB	0.12	0.045	3.3	1.6

**Note:**

- For rural-eMBB, Requirement of 5% SE is not applicable for Config-C (700MHz, ISD=6000m)
- For rural-eMBB, Requirement of Avg SE is mandatory for Config-C and one of Config A (700MHz, ISD=1732m) or B (4GHz, ISD=1732m)

## Evaluation Methodology

Refer to Section 7.1.1 and 7.1.2 of ITU-R M.2412

### Results

#### Indoor Hotspot – eMBB

EUHT Self Evaluation Report provides for the assumption under which to evaluate various configurations in their respective scenario. 5GIF has used those assumptions and where not possible has mentioned the same in the remarks. For Indoor Hotspot the Configuration A has been evaluated.

Table 4-20 Technical Assumptions InH Configuration

Indoor Hotspot - eMBB Technical configuration Parameters	Downlink	Uplink	Remarks
Multiple access	OFDMA	OFDMA	DT
Carrier Frequency	For configuration A: 4GHz For configuration B: 30GHz	For configuration A: 4GHz For configuration B: 30GHz	
Duplexing	TDD	TDD	
Network synchronization	Synchronized	Synchronized	
Modulation	Up to 1024 QAM	Up to 1024 QAM	
Coding on TCH	LDPC	LDPC	
Subcarrier spacing	For configuration A: 78.125 kHz;	For configuration A: 78.125 kHz;	

	For configuration B: 390.625kHz	For configuration B: 390.625kHz		
Simulation bandwidth	For configuration A:20MHz For configuration B: 100MHz	For configuration A:20MHz For configuration B: 100MHz	Refer to M.2412 – Table 5	
Frame structure	DL:UL = 2:1	DL:UL = 2:1	SER	
Transmission scheme	Adaptive SU/MU-MIMO	Adaptive SU/MU-MIMO		
MU dimension	Maximum factor of 2	Maximum factor of 2		
SU dimension	Up to 8 layers	Up to 8 layers		
DL-SCH transmission	8 DL-SCH ports in 20MHz bandwidth; 2symbols per 20ms	8 UL-SCH ports in 20MHz bandwidth; 2symbols per 20ms		
CSI feedback	CSI: every 20ms	-		
Interference measurement	SU-CQI	-		DT
ACK/NACK delay	Current frame	-		SER
Re-transmission delay	Next available frame	Next available frame		
Antenna configuration at TRxP	8Tx, (8,4,2,1,1; 1,4)	8Rx, (8,4,2,1,1; 1,4)		
Antenna configuration at UE	8Rx, (1,4,2,1,1; 1,4)	8Tx, (1,4,2,1,1; 1,4)		
Scheduling	PF	PF		
Receiver	MMSE - IRC	MMSE - IRC	EUHT self- evaluation report mentions - K-best but enough information regarding receiver model used is not given. 5GIF has used MMSE as the receiver model for evaluation of EUHT candidate submissions.	
Channel estimation	Non-ideal	Non-ideal	SER	
Power control parameter	-	P0=-60, alpha=0.6		
TRxP number per site	1 TRxP per site; 3 TRxPs per site	1 TRxP per site; 3 TRxPs per site		
Mechanic tilt	110° in GCS	110° in GCS		
Electronic tilt	90° in LCS	90° in LCS		
Handover margin (dB)	1	1		
Wrapping around method	No wrap around	No wrap around		
Criteria for selection for serving TRxP	Maximizing RSRP where the digital beamforming is not considered	Maximizing RSRP where the digital beamforming is not considered		
Note: DT= Description Template, SP = Specification, SER- Self. Eval. Report in 5D/1300				



Table 4-21 DL Overhead Assumption

Indoor Hotspot - eMBB		EUHT TDD	Overhead (Frame Duration: 20ms)
Overhead assumption <sup>15</sup>			
IMT bands	CCH	1 symbol per 2ms (per frame)	10
	DL-SCH	2symbols per 20ms, 8 ports for 8Tx	2
	DRS	For 8Tx: Up to 8 ports; 12 symbols per 2ms	120
	GI	1 symbol per 2ms	10
	Preamble	1 short preamble symbol and 1 long preamble symbol per 2ms	20
	SICH	1 symbol per 2ms	10
	Total symbols	93 symbols per 2ms	930
	Total OH		172
	Total OH (%)		18.49%

Table 4-22 UL Overhead Assumptions

Indoor Hotspot - eMBB		EUHT TDD	Overhead (Frame Duration: 20ms)
Overhead assumption			
IMT bands	UL-SRCH	2 symbols per 20ms (per 10 frames)	2
	USCH	1 symbol per 2ms (per frame)	10
	DRS	For 8Tx: Up to 8 ports; 6 symbols per 2ms	60
	UL-SCH	20 ms period, 8 ports for 8Tx; 2symbols per 20ms	2
	GI	1 symbol per 2ms	10
	Total symbols	46 symbols per 2ms	460
	Total OH		84
	Total OH (%)		18.26%

As per the above considered assumptions and the ITU-R guidelines, the following simulation results have been obtained.

Table 4-23 Downlink Spectral efficiency for EUHT in Indoor Hotspot – eMBB

Scheme and antenna configuration	Sub-carrier spacing (kHz)	Frame structure	ITU Requirement		Channel model A	Channel Model B
					BW= 20MHz	BW= 20MHz
8x8 adaptive SU/MU - MIMO	78.125	DL:UL = 2:1	Average [bit/s/Hz/TRxP]	9	4.99	4.93
			5th-tile [bit/s/Hz]	0.3	0.03	0.07

**Table 4-24 Downlink Spectral efficiency for EUHT in Indoor Hotspot – eMBB (Evaluation configuration A, CF=4 GHz, for 12TRxP)**

<sup>15</sup> The overhead assumptions are as per those specified in the SER of EUHT.

Scheme and antenna configuration	Sub-carrier spacing (kHz)	Frame structure	ITU Requirement		Channel model A	Channel Model B
					BW= 20MHz	BW= 20MHz
8x8 adaptive SU/MU - MIMO	78.125	DL:UL = 2:1	Average [bit/s/Hz/TRxP]	9	7.34	7.35
			5th-tile [bit/s/Hz]	0.3	0.24	0.23

**Table 4-25 Uplink Spectral efficiency for EUHT in Indoor Hotspot – eMBB (Evaluation configuration A, CF=4 GHz, for 36TRxP)**

Scheme and antenna configuration	Sub-carrier spacing (kHz)	Frame structure	ITU Requirement (II)		Channel model A	Channel Model B
					BW= 20MHz	BW= 20MHz
8x8 adaptive SU/MU - MIMO	78.125	DL:UL = 2:1	Average [bit/s/Hz/TRxP]	6.75	2.71	2.76
			5th-tile [bit/s/Hz]	0.21	0.08	0.08

**Table 4-26 Uplink Spectral efficiency for EUHT in Indoor Hotspot – eMBB (Evaluation configuration A, CF=4 GHz, for 12TRxP)**

Scheme and antenna configuration	Sub-carrier spacing (kHz)	Frame structure	ITU Requirement		Channel model A	Channel Model B
					BW= 20MHz	BW= 20MHz
8x8 adaptive SU/MU - MIMO	78.125	DL:UL = 2:1	Average [bit/s/Hz/TRxP]	6.75	3.93	3.98
			5th-tile [bit/s/Hz]	0.21	0.16	0.18

The above results show that the requirements are not being met under the current assumptions.

To understand and investigate such low values of spectral efficiency compared to 3GPP NR, we compared the system level simulator statistics to identify possible reasons. The analysis is described below.

### System Level Analysis Outcomes

Figure 4.6 SINR CDF plot with their respective System Level Assumptions

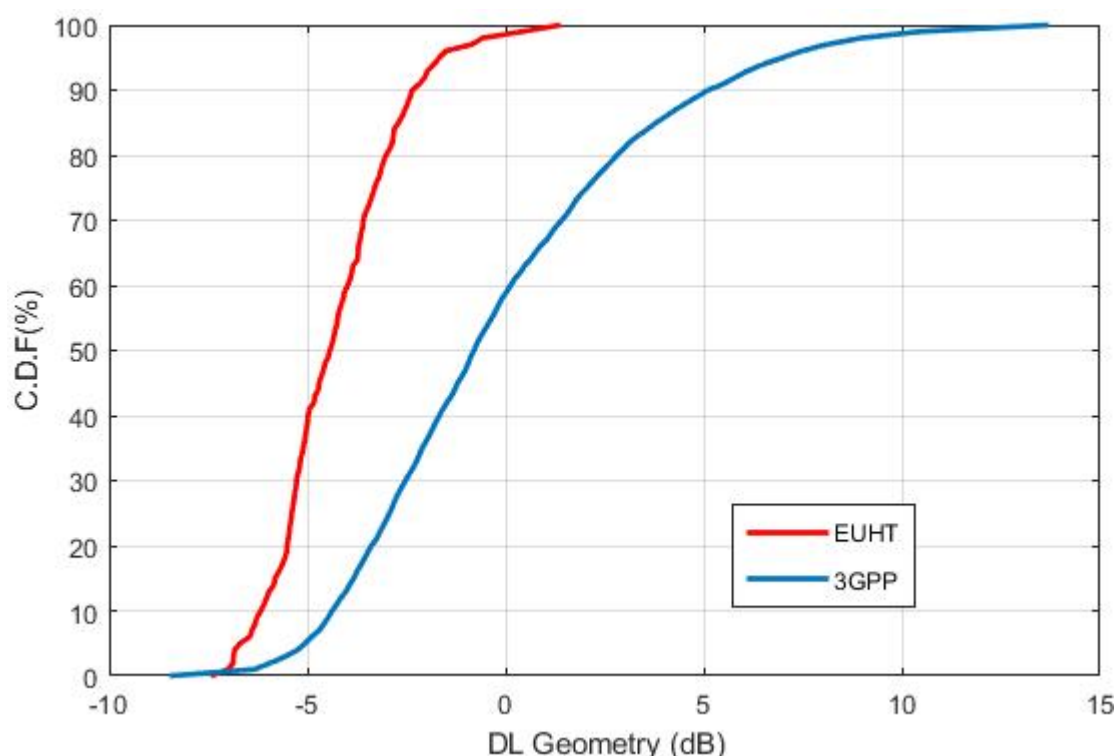

The above CDF has been obtained using the calibrated system level simulator for the assumptions provided by EUHT and 3GPP NR for Avg. Spectral Efficiency simulation, these assumptions have been followed to produce the following results also.

- EUHT provides an antenna configuration of  $(M,N,P,M_g,N_g;M_p,N_p)=(8,4,2,1,1,1,4)$  with Mechanical Tilt=110 and Electrical Tilt=90. This would translate to eight TxRUs each with  $8 \times 1$  antenna element.
- 3GPP NR provides an antenna configuration of  $(M,N,P,M_g,N_g;M_p,N_p)=(4,4,2,1,1,4,4)$  with Mechanical Tilt=110 and Electrical Tilt=90. This would translate to 32 TxRUs each with 1 antenna element.

OBSERVATION 1 : Figure 4.6 shows that the >90% of STAs have SINR value less 0dB compared to 3GPP NR with 60% of the UEs are less than 0 dB.

OBSERVATION 2:

- Based on the BLER results in AWGN channel, the performance of EUHT LDPC coding was found to be inferior to that of NR LDPC coding.
- Also, for the same large data packet, the frame or packet error rate of EUHT LDPC coding is higher than that of NR LDPC coding (See Annex - J.2)

OBSERVATION 3:

It can be observed from Figure 4e that these could be a result of an inappropriate antenna configuration choice.

Figure 4.7 Maximum Antenna Gain Possible in the network layout for EUHT(left) and 3GPP NR(right) with one BS active. Red is +10dB and blue is -10dB.

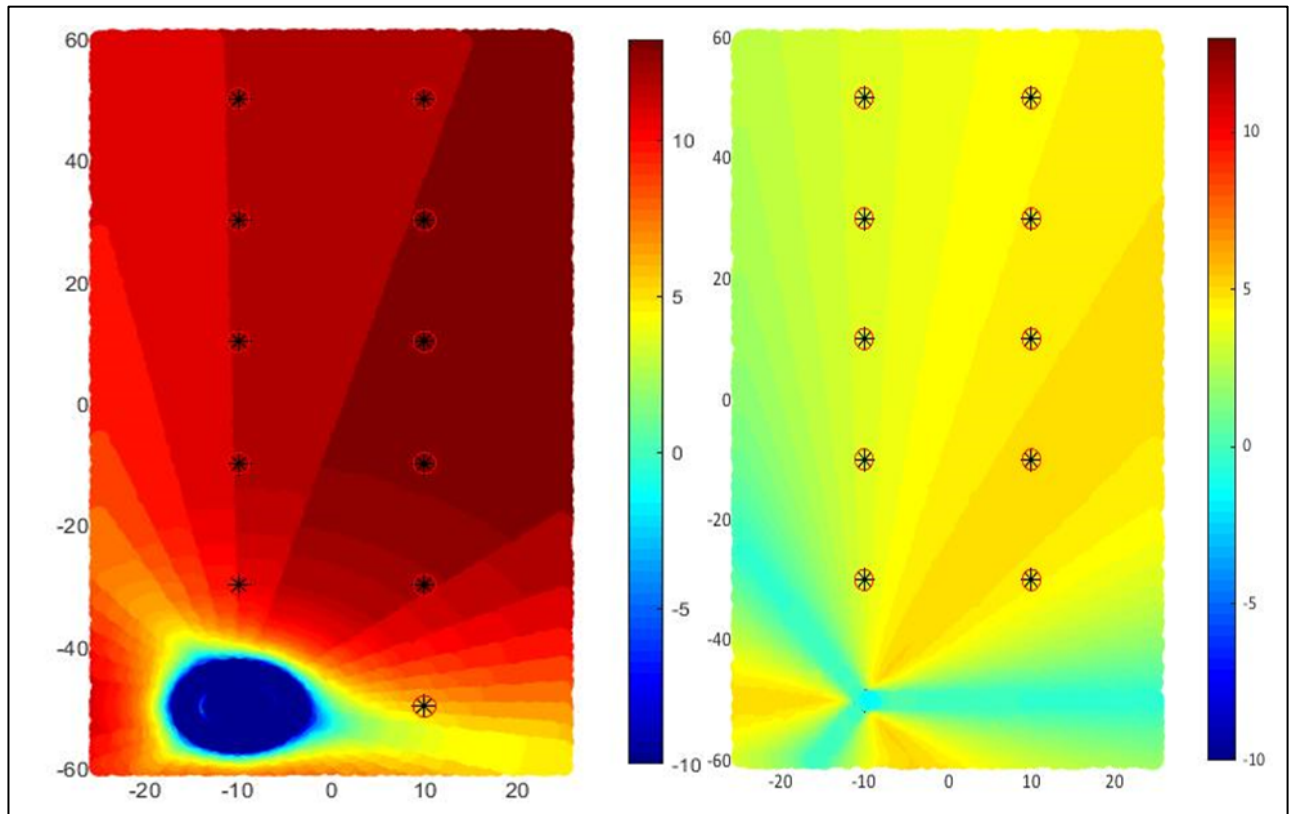
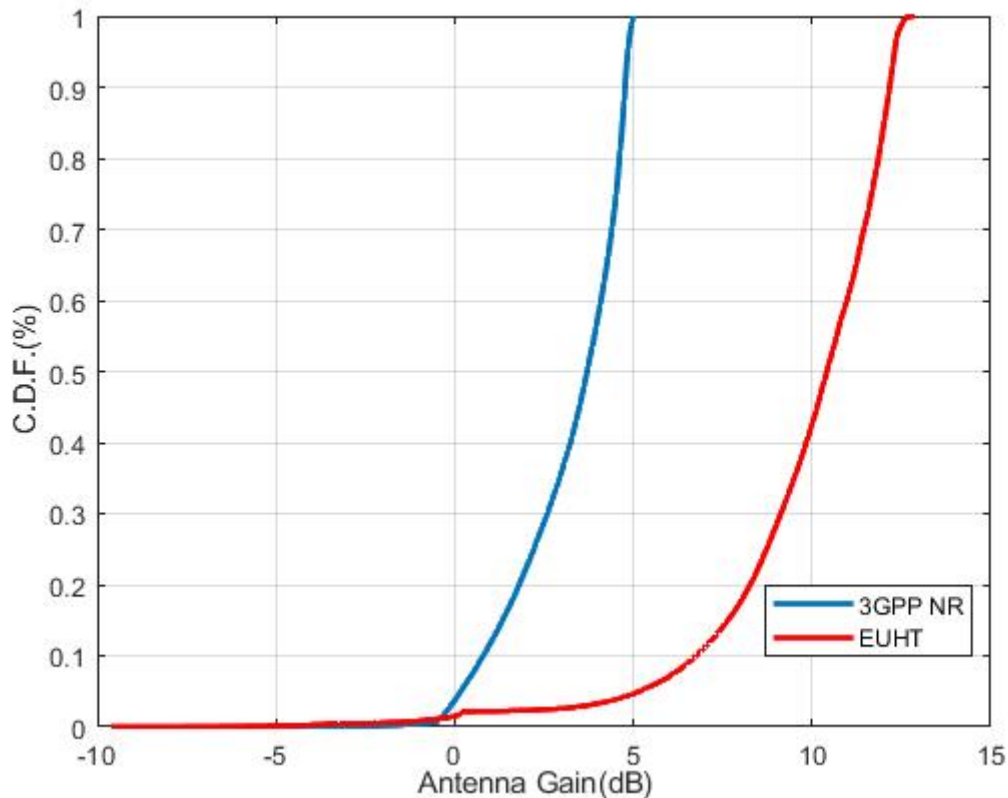

Figure 4.7 shows the Antenna Gains available at different locations in the network layout when one BS is active (considering 3 TRxPs). From the Figure 4.7 it is observed that higher antenna gains are obtained at locations away from the activated cell while no gains are observed in the closed cell itself in case of EUHT. The 3GPP NR shows better gains in the closest cell itself whereas negative gains towards UEs away from the hotspot/TRxP.

Figure 4.8 The CDF plot of the Antenna Gains of the UEs with their Associated TRxP



From Figure 4.8, we see that the antenna gains for the users in EUHT configuration is higher than that in the 3GPP NR configuration. We can also observe that higher antenna gains (greater than 5 for 95% UEs) of the UEs with their associated TRxP is only possible if the TRxPs are from cells other than that of the UEs in case of EUHT. Therefore, it can be concluded that most the UEs are associating with TRxPs other than that in their cell in case of EUHT. This should decrease the effective SINR values for a given UE with its associated TRxP since the received signal would be lower due to pathloss and experience higher interference due to signal from TRxPs in their respective cell.

This can be also observed from Figure 4.9 which shows the SINR of a UE with its associated TRxP at a given location in the network layout.

Figure 4.9 SINR Pattern of the UEs with their Associated TRxP. EUHT(left) & 3GPP NR(right)

From Figure 4.9 the SINR of UEs in case of EUHT is lower as compared to 3GPP-NR even though the number of Antenna Elements in a TxRU is 8 in case of EUHT and 1 in case of 3GPP NR. This could be a possible explanation of EUHT not meeting the requirements for Spectral Efficiencies in Indoor Hotspot-eMBS Scenario.

### 5GIF Observations

- The Spectral Efficiencies value obtained for EUHT fails to meet the requirements for Indoor Hotspot Configuration A.
- The possible reasons can be the choice of Antenna Configuration and Electrical, Mechanical Steering.
- Also, the number of TXRUs are 8 in case of EUHT as compared to 32 in case of 3GPP NR which can lead to lower capacity and digital beamforming gains.
- Also, the number of TXRUs are capped at 8 in case of EUHT which can be a limiting factor.
- The antenna gains seen in EUHT are higher than that in 3GPP NR, but this translates to higher interference and does not provide for higher signal strength.

### Evaluation Configuration B

*Table 4-27 Downlink Spectral efficiency for EUHT in Indoor Hotspot – eMBB  
(Evaluation configuration B, CF=30 GHz, for 36TRxP)*

Scheme and antenna configuration	Sub-carrier spacing (kHz)	Frame structure	ITU Requirement		Channel model A/B
					BW=100MHz
8x8 adaptive SU/MU - MIMO	78.125	DL:UL = 2:1	Average [bit/s/Hz/TRxP]	9	4.77
			5th-tile [bit/s/Hz]	0.3	0.01

*Table 4-28 Downlink Spectral efficiency for EUHT in Indoor Hotspot – eMBB  
(Evaluation configuration B, CF=30 GHz, for 12TRxP)*

Scheme and antenna configuration	Sub-carrier spacing (kHz)	Frame structure	ITU Requirement		Channel model A/B
					BW=100MHz
8x8 adaptive SU/MU - MIMO	78.125	DL:UL = 2:1	Average [bit/s/Hz/TRxP]	9	5.42
			5th-tile [bit/s/Hz]	0.3	0.06

*Table 4-29 Uplink Spectral efficiency for EUHT in Indoor Hotspot – eMBB  
(Evaluation configuration B, CF=30 GHz, for 36TRxP)*

Scheme and antenna configuration	Sub-carrier spacing (kHz)	Frame structure	ITU Requirement		Channel model A/B
					BW=100MHz
8x8 adaptive SU/MU - MIMO	78.125	DL:UL = 2:1	Average [bit/s/Hz/TRxP]	6.75	3.61
			5th-tile [bit/s/Hz]	0.21	0.10

Table 4-30 Uplink Spectral efficiency for EUHT in Indoor Hotspot – eMBB  
(Evaluation configuration B, CF=30 GHz, for 12TRxP)

Scheme and antenna configuration	Sub-carrier spacing (kHz)	Frame structure	ITU Requirement		Channel model A/B
					BW=100MHz
8x8 adaptive SU/MU - MIMO	78.125	DL:UL = 2:1	Average [bit/s/Hz/TRxP]	6.75	2.48
			5th-tile [bit/s/Hz]	0.21	0.05

### Dense Urban – eMBB

Table 4-31 Technical Assumptions – Dense Urban

Dense Urban - eMBB			
Technical configuration Parameters	Downlink	Uplink	Remarks
Multiple access	OFDMA	OFDMA	Refer to DT
Duplexing	TDD	TDD	
Network synchronization	Synchronized	Synchronized	
Modulation	Up to 1024 QAM	Up to 1024 QAM	
Carrier Frequency	For configuration A: 4GHz For configuration B: 30GHz	For configuration A: 4GHz For configuration B: 30GHz	
Coding on TCH	LDPC	LDPC	
Numerology	For configuration A: 78.125 kHz For configuration B: 390.625kHz	For configuration A: 78.125 kHz For configuration B: 390.625kHz	Refer to SER
Simulation bandwidth	For configuration A: 20MHz For configuration B: 100MHz	For configuration A: 20MHz For configuration B: 100MHz	
Frame structure	DL:UL = 2:1	DL:UL = 2:1	
Transmission scheme	Adaptive SU/MU-MIMO	Adaptive SU/MU-MIMO	
MU dimension	Maximum factor of 4	Maximum factor of 4	
SU dimension	Up to 8 layers	Up to 8 layers	
DL-SCH transmission	8 DL-SCH ports in 20MHz bandwidth; 2symbols per 20ms	8 UL-SCH ports in 20MHz bandwidth; 2symbols per 20ms	
CSI feedback	CSI: every 20ms	-	
Interference measurement	SU-CQI	-	
ACK/NACK delay	Current frame	-	
Re-transmission delay	Next available frame	Next available frame	
Antenna configuration at TRxP	8Tx, (8,4,2,1,1; 1,4)	8Rx, (8,4,2,1,1; 1,4)	



Antenna configuration at UE	8Rx, (1,4,2,1,1; 1,4)	8Tx, (1,4,2,1,1; 1,4)	Refer to SER
Scheduling	PF	PF	
Receiver	MMSE – IRC	MMSE - IRC	Refer to DT
Channel estimation	Non-ideal	Non-ideal	
Power control parameter	-	P0=-60, alpha=0.6	
TRxP number per site	3	3	Refer to SER
Mechanic tilt	110° in GCS	110° in GCS	
Electronic tilt	90° in LCS	90° in LCS	
Handover margin (dB)	1	1	
Wrapping around method	Geographical distance-based wrapping	Geographical distance-based wrapping	
Criteria for selection for serving TRxP	Maximizing RSRP where the digital beamforming is not considered	Maximizing RSRP where the digital beamforming is not considered	
Note: DT= Description Template, SP = Specification, SER- Self. Eval. Report in 5D/1300			

Table 4-32 Overhead Assumptions - DL

Dense Urban - eMBB Overhead assumption		DL OH Para EUHT TDD	DL_OH (symbols/20ms)
IMT bands	CCH	1 symbol per 2ms (per frame)	10
	DL-SCH	2symbols per 20ms, 8 ports for 8Tx	2
	DRS	For 8Tx: Up to 8 ports; 12 symbols per 2ms	120
	GI	1 symbol per 2ms	10
	Preamble	1 short preamble symbol and 1 long preamble symbol per 2ms	20
	SICH	1 symbol per 2ms	10
	Total symbols	93 symbols per 2ms	930
	Total OH		172
Total OH (%)		18.49%	

Table 4-33 Overhead Assumptions – UL

Dense Urban - eMBB Overhead assumption		UL OH Para EUHT TDD	UL_OH (symbols/20ms)
IMT bands	UL-SRCH	2 symbols per 20ms (per 10 frames)	2
	USCH	1 symbol per 2ms (per frame)	10
	DRS	For 8Tx: Up to 8 ports; 6 symbols per 2ms	60
	UL-SCH	20 ms period, 8 ports for 8Tx; 2symbols per 20ms	2
	GI	1 symbol per 2ms	10
	Total symbols	46 symbols per 2ms	460
	Total OH		84
	Total OH (%)		18.26%

### Evaluation Configuration A

**Table 4-34 Spectral efficiency for EUHT in Dense Urban – eMBB  
(Evaluation configuration A, CF=4 GHz)**

Downlink

Scheme and antenna configuration	Sub-carrier spacing (kHz)	Frame structure	ITU Requirement		Channel model A
					BW= 20MHz
8T, (8,4,2,1,1; 1,4) 8R, (1,4,2,1,1; 1,4) MU-MIMO	78.125	DL:UL = 2:1	Average [bit/s/Hz/TRxP]	7.8	7.68
			5 <sup>th</sup> -tile [bit/s/Hz]	0.225	0.25

Uplink

Scheme and antenna configuration	Sub-carrier spacing (kHz)	Frame structure	ITU Requirement		Channel model A
					BW= 20MHz
8T, (8,4,2,1,1; 1,4) 8R, (1,4,2,1,1; 1,4) MU-MIMO	78.125	DL:UL = 2:1	Average [bit/s/Hz/TRxP]	5.4	3.58
			5 <sup>th</sup> -tile [bit/s/Hz]	0.15	0.1

The above results show that the requirements are not being met under the current assumptions. To explore and verify the 5GIF simulator outcome system level analysis was done which gave possible reasons for such results. The analysis is described below.

## System Level Analysis Outcomes

Figure 4.10 SINR CDF plot with their respective System Level Assumptions

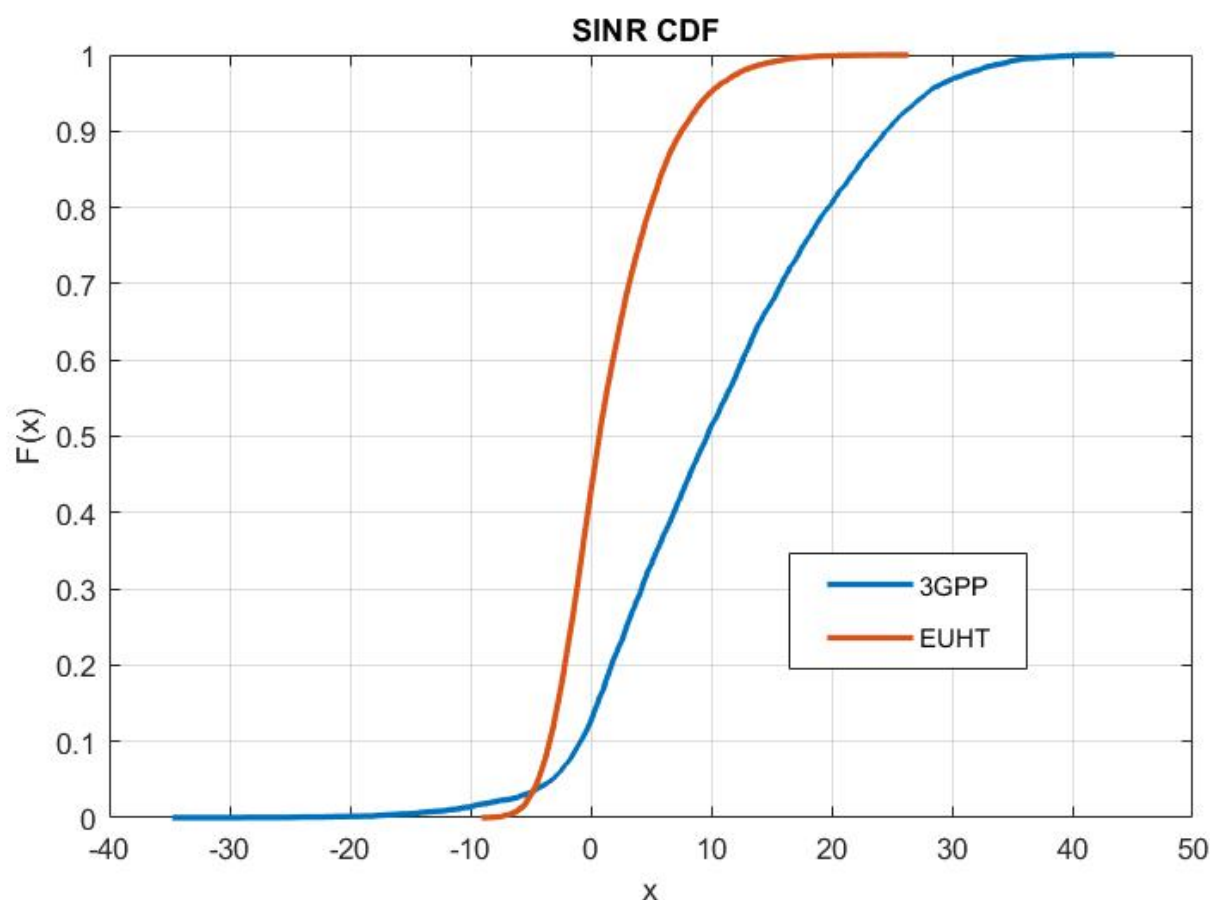

Figure 4.10 shows the CDF has been obtained using the calibrated system level simulator for the assumptions provided by EUHT and 3GPP NR for Avg. Spectral Efficiency simulation, these assumptions have been followed to produce the following results also.

- EUHT provides an antenna configuration of  $(M,N,P,M_g,N_g;M_p,N_p)=(8,4,2,1,1,1,4)$  with Mechanical Tilt= $110^\circ$  and Electrical Tilt= $90^\circ$ . This would translate to eight TxRUs each with  $8 \times 1$  antenna element.
- 3GPP NR provides an antenna configuration of  $(M,N,P,M_g,N_g;M_p,N_p)=(8,8,2,1,1,2,8)$  with Mechanical Tilt= $110^\circ$  and Electrical Tilt= $90^\circ$ . This would translate to 32 TxRUs each with 1 antenna element.

Figure 4.10 shows that the SINR values of the UEs are less than 0 dB for most of the UEs in the EUHT case as compared to better SINR values in the 3GPP NR case. Also see LDPC performance in Annex – J.2

It can be observed from Figure 4i that these could be a result of an inappropriate antenna configuration choice.

OBSERVATION 1 : 10 shows that the 50% of STAs have SINR value less 0dB compared to 3GPP NR with 40% of the UEs are less than 0 dB.

OBSERVATION 2:

- a) Based on the BLER results in AWGN channel, the performance of EUHT LDPC coding was found to be inferior to that of NR LDPC coding.

- b) Also, for the same large data packet, the frame or packet error rate of EUHT LDPC coding is higher than that of NR LDPC coding (See Annex - J.2)

**OBSERVATION 3:**

It can be observed from Figure 4.11 that these could be a result of an inappropriate antenna configuration choice.

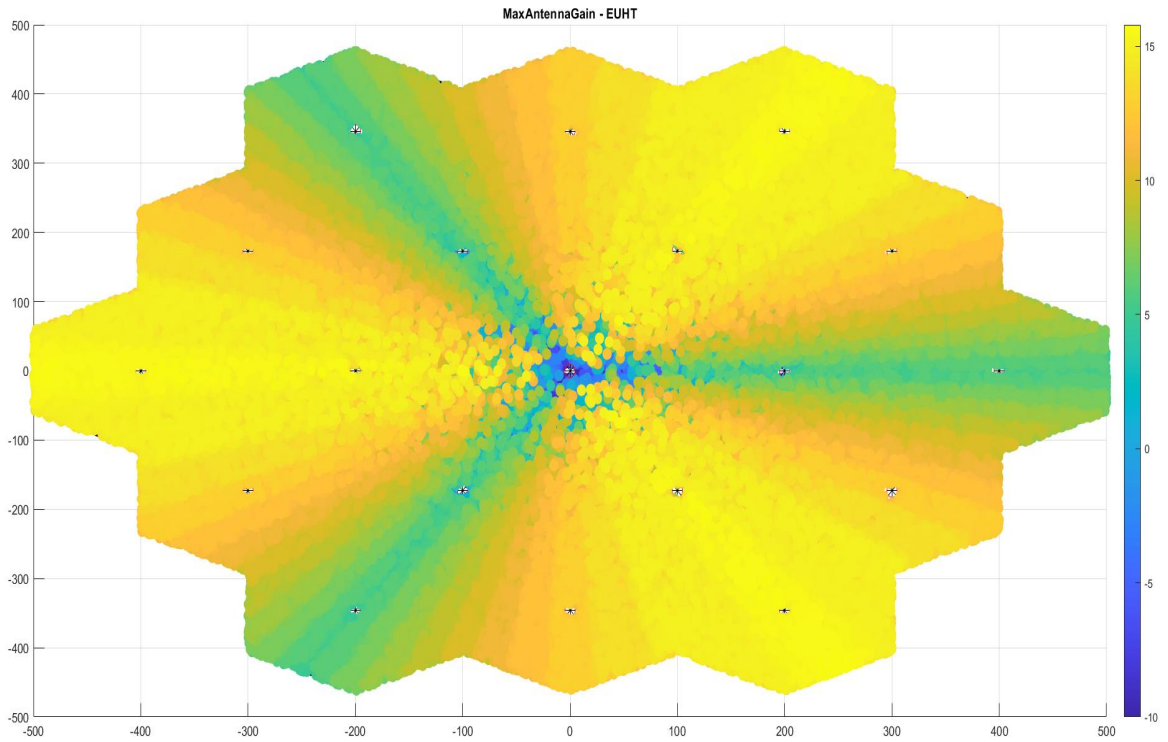

Figure 4.11 Maximum Antenna Gain Possible in the network layout for EUHT(top) and 3GPP NR(bottom) with one BS active. Yellow is +15dB and blue is -10~-15dB

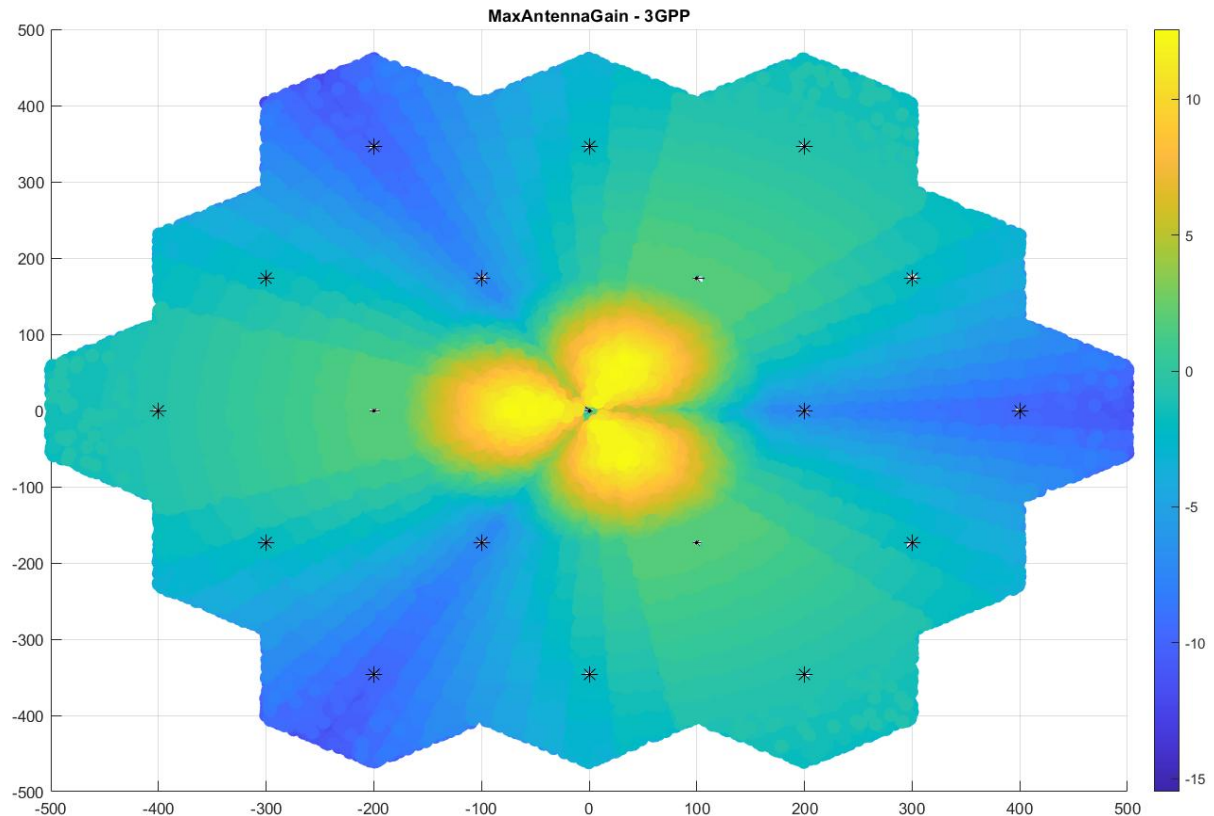

Figure 4-11 shows the Antenna Gains available at different locations in the network layout when one BS is active (considering 3 TRxPs). From the Figure 4i it is observed that higher antenna gains are obtained at locations away from the activated cell while no gains are observed in the activated cell itself in case of EUHT. The 3GPP NR shows good gains in the cell itself with negative gains in locations away from the BS.

Also, in the case of 3GPP NR phased array beam forming is used which improves the SINR values because narrow beamwidth giving spatial diversity. Figure 4j shown below gives a visual representation of the associated beam (one of 12 beams) as per the NR configurations for Config-A of Dense Urban (See Chapter 2). Note only the center cell is activated to inspect the spatial footprint of the beams.

Figure 4.12 Visualisation of beams with varying beam ids as shown in the color gradient with one active base station

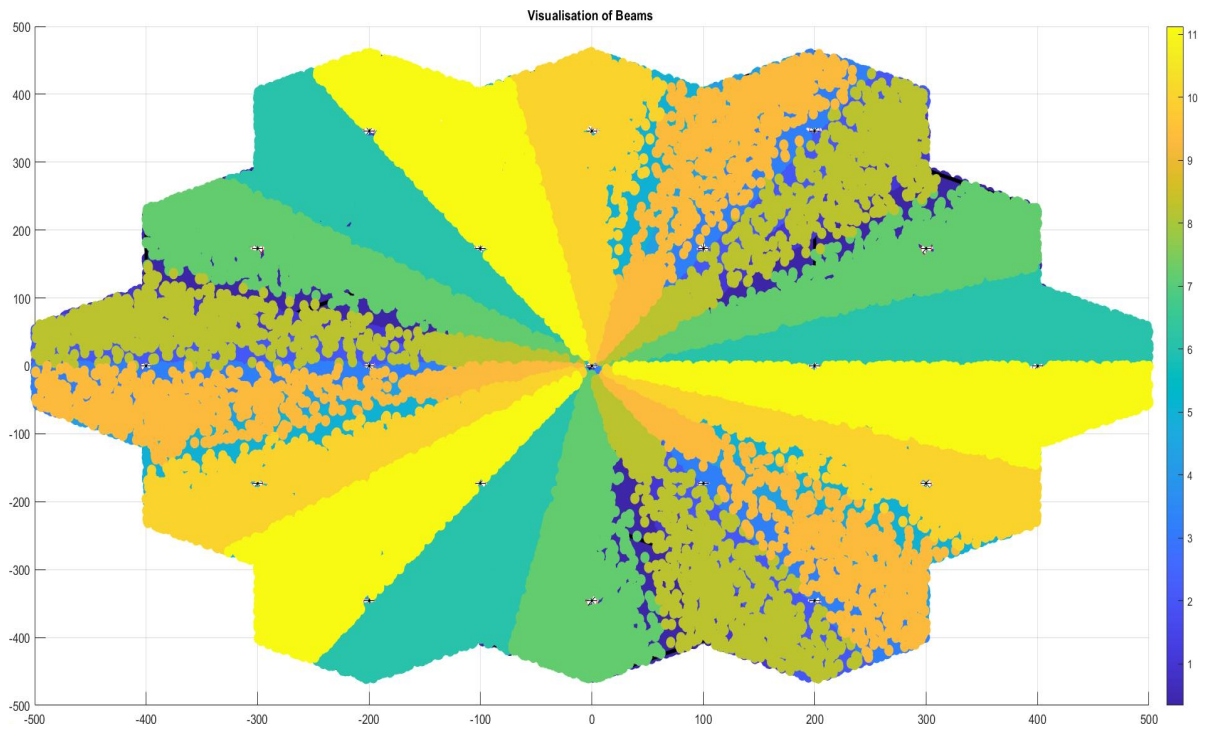
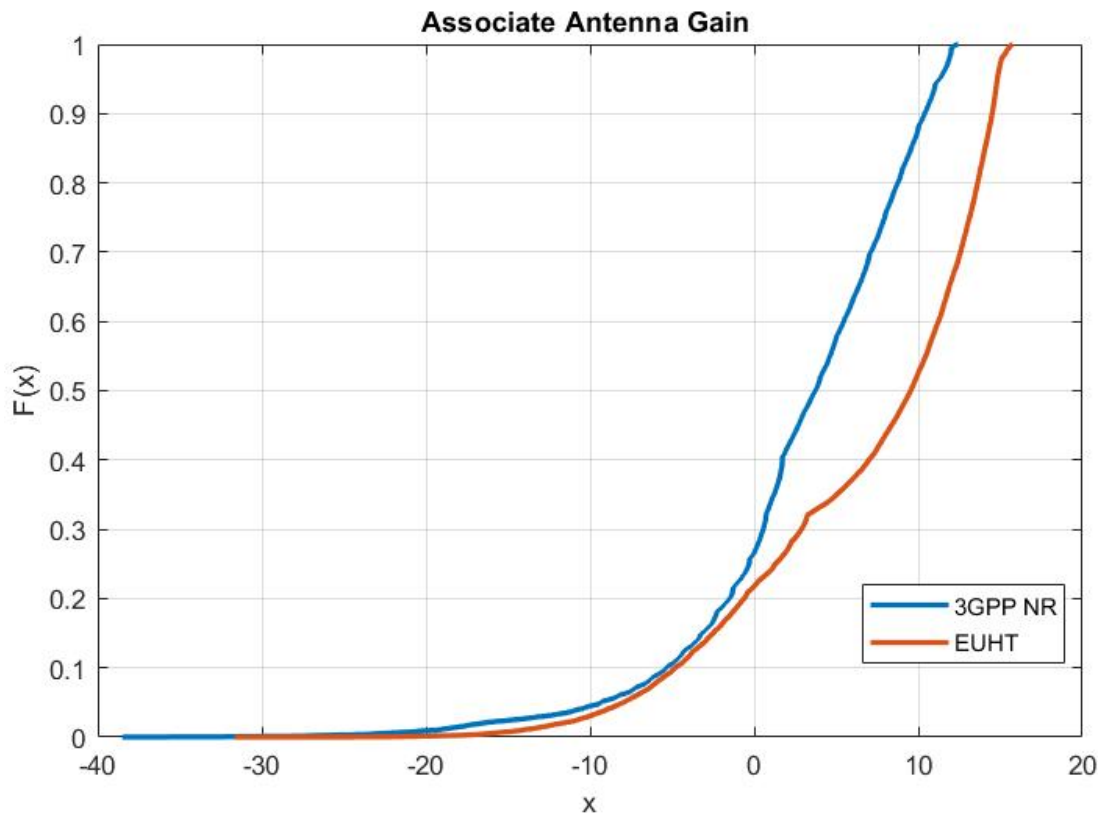

Figure 4.13 The CDF plot of the Antenna Gains of the UEs with their Associated TRxP



From Figure 4.13, we see that the antenna gains for the users in EUHT configuration is higher than that in the 3GPP NR configuration. We can also observe that higher antenna gains (greater than 5 for 95% UEs) of the UEs with their associated TRxP is only possible if the TRxPs are from cells other than that of the UEs in case of EUHT. Therefore, it can be concluded that most the UEs are associating with COAI-5GIF



TRxPs other than that in their cell in case of EUHT. This should decrease the effective SINR values for a given UE with its associated TRxP since the received signal would be lower due to pathloss and experience higher interference due to signal from TRxPs in their respective cell. This can be also observed from figure 5 which shows the SINR of a UE with its associated TRxP at a given location in the network layout.

Figure 4.14 SINR Pattern of the UEs with their Associated TRxP. EUHT(top) & 3GPP NR(bottom)

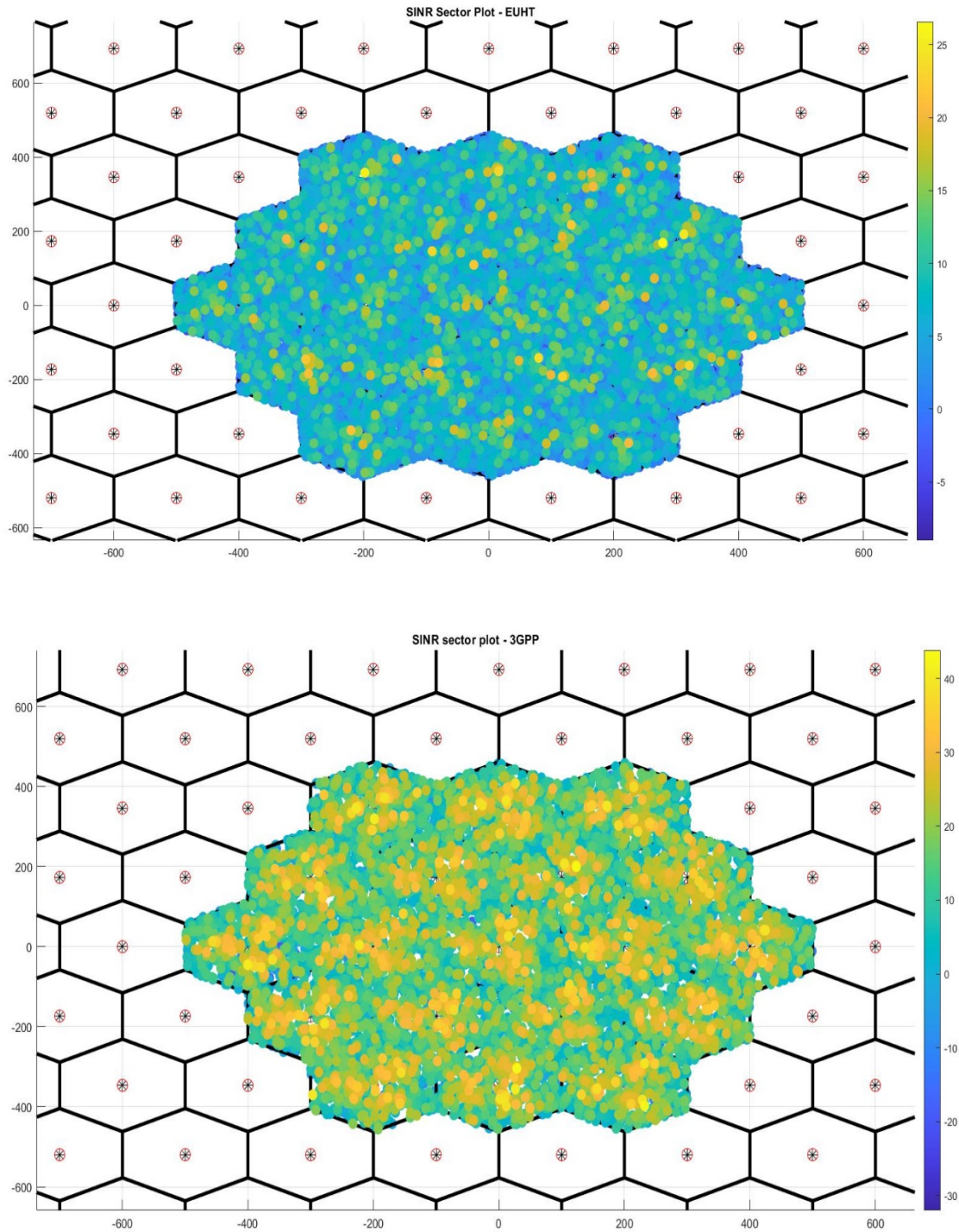

From Figure 4.14 the SINR of UEs in case of EUHT is lower as compared to 3GPP NR even though the number of Antenna Elements in a TxRU is 8 in case of EUHT and 1 in case of 3GPP NR. This could be a possible explanation of EUHT not meeting the requirements for Spectral Efficiencies in Dense Urban-eMBB Scenario.

### Evaluation Configuration B

*Table 4-35 DL spectral efficiency for EUHT in Dense Urban – eMBB (Evaluation configuration B, CF=30 GHz)*

Scheme and antenna configuration	Sub-carrier spacing (kHz)	Frame structure	ITU Requirement		Channel model A/B
			Average [bit/s/Hz/TRxP]	5 <sup>th</sup> -tile [bit/s/Hz]	BW=20MHz
8x8 adaptive SU/MU -MIMO	78.125	DL:UL=2:1	7.8		5.53
				0.225	0.001

*Table 4-36 UL spectral efficiency for EUHT in Dense Urban – eMBB (Evaluation configuration B, CF=30 GHz)*

Scheme and antenna configuration	Sub-carrier spacing (kHz)	Frame structure	ITU Requirement		Channel model A/B
			Average [bit/s/Hz/TRxP]	5 <sup>th</sup> -tile [bit/s/Hz]	BW=20MHz
8x8 adaptive SU/MU -MIMO	78.125	DL:UL=2:1	5.4		1.70
				0.15	0.0

### Evaluation Report

*Table 4-37 Evaluation Configuration A*

Scenario	Performance Measure	ITU Requirements	5GIF Results-Channel A	5GIF Results-Channel B	Conclusion Meets Requirement (Yes/No)	Remarks
Indoor (12 TRxP)	Average spectral efficiency	DL:9 UL: 6.75	DL : 7.34 UL: 3.93	DL: 7.35 UL: 3.98	No No	Due to the antenna configuration chosen by EUHT and tilt angles considered the STAs close to the CAP which are supposed to receive high SINR and antenna gain are experiencing very poor SINR and antenna gains. This has resulted in EUHT technology in not meeting the ITU minimum requirements.
	5 <sup>th</sup> % user spectral efficiency	DL:0.3 UL: 0.21	DL: 0.24 UL: 0.16	DL: 0.23 UL: 0.18	No No	
Indoor (36 TRxP)	Average spectral efficiency	DL:9 UL: 6.75	DL: 4.99 UL: 2.71	DL: 4.93 UL: 2.76	No No	
	5 <sup>th</sup> % user spectral efficiency	DL:0.3 UL: 0.21	DL: 0.03 UL: 0.08	DL: 0.07 UL: 0.08	No No	
Dense Urban	Average spectral efficiency	DL:7.8 UL: 5.4	DL: 7.68 UL: 3.58	DL: 7.74 UL: 3.71	No No	
	5 <sup>th</sup> % user spectral efficiency	DL:0.225 UL: 0.15	DL: 0.25 UL: 0.1	DL: 0.22 UL: 0.08	Yes No	

*Table 4-38 Evaluation Configuration B*



Scenario	Performance Measure	ITU Requirements	5GIF Results-Channel A/B	Conclusion Meets Requirement (Yes/No)	Remarks
Indoor (12 TRxP)	Average spectral efficiency	DL:9 UL: 6.75	DL : 5.42 UL: 2.48	No No	Due to the antenna configuration chosen by EUHT and tilt angles considered the STAs close to the CAP which are supposed to receive high SINR and antenna gain are experiencing very poor SINR and antenna gains. This has resulted in EUHT technology in not meeting the ITU minimum requirements.
	5 <sup>th</sup> % user spectral efficiency	DL:0.3 UL: 0.21	DL: 0.06 UL: 0.05	No No	
Indoor (36 TRxP)	Average spectral efficiency	DL:9 UL: 6.75	DL: 4.77 UL: 3.61	No No	
	5 <sup>th</sup> % user spectral efficiency	DL:0.3 UL: 0.21	DL: 0.01 UL: 0.10	No No	
Dense Urban	Average spectral efficiency	DL:7.8 UL: 5.4	DL: 5.53 UL: 1.70	No No	
	5 <sup>th</sup> % user spectral efficiency	DL:0.225 UL: 0.15	DL: 0.001 UL: 0.0	No No	

#### 4.2.3.2 Reliability

### Requirements

The minimum requirement for the reliability is  $1-10^{-5}$  success probability of transmitting a layer 2 PDU (protocol data unit) of 32 bytes within 1 ms in channel quality of coverage edge for the Urban Macro-URLLC test environment, assuming small application data (e.g. 20 bytes application data + protocol overhead).

### Evaluation Methodology

Refer to Section 7.1.5 of ITU-R M.2412

### Results

### Technical Assumptions-

Table 4-39 System Level Parameters

Technical configuration Parameters	Downlink	Uplink	Remarks
Multiple access	OFDMA	OFDMA	Refer to DT
Carrier Frequency for evaluation	4 GHz	4 GHz	Refer to M.2412
Duplexing	TDD	TDD	Refer to DT
Modulation	Up to 1024 QAM	Up to 1024 QAM	
Coding on TCH	LDPC	LDPC	
Numerology	78.125 kHz SCS	78.125 kHz SCS	
Simulation bandwidth	20 MHz	20 MHz	Refer to M.2412
Frame structure	DL:UL = 2:1	DL:UL = 2:1	
Transmission scheme	SU-MIMO	SU-MIMO	

SU dimension	1	1	Refer to SER
Antenna configuration at TRxP	8Tx, (8,4,2,1,1; 1,4)	8Rx, (8,4,2,1,1; 1,4)	
Antenna configuration at UE	2Rx, (1,1,2,1,1; 1,1)	2Tx, (1,1,2,1,1; 1,1)	
Scheduling	PF	PF	
Receiver	MMSE - IRC	MMSE - IRC	EUHT uses K-best but sufficient information regarding receiver model used is not given. 5GIF has used MMSE as the receiver model for evaluation of EUHT candidate submissions.
Channel estimation	Non-ideal	Non-ideal	Refer to SER
Power control parameters	-	P0= -86, alpha = 0.8	
System configuration parameters			
TRxP number per site	3		
Mechanic tilt	90° in GCS		
Electronic tilt	99° in LCS		
Handover margin (dB)	1		
Wrapping around method	Geographical distance-based wrapping		Refer to SER
Criteria for selection for serving TRxP	Maximizing RSRP where the digital beamforming is not considered		
Note: DT= Description Template, SP = Specification, SER- Self. Eval. Report in 5D/1300			
Technical configuration Parameters	Downlink	Uplink	Remarks
Multiple access	OFDMA	OFDMA	Refer to DT
Carrier Frequency for evaluation	4 GHz	4 GHz	Refer to M.2412
Duplexing	TDD	TDD	Refer to DT
Modulation	Up to 1024 QAM	Up to 1024 QAM	
Coding on TCH	LDPC	LDPC	
Numerology	78.125 kHz SCS	78.125 kHz SCS	
Simulation bandwidth	20 MHz	20 MHz	Refer to M.2412
Frame structure	DL:UL = 2:1	DL:UL = 2:1	Refer to SER
Transmission scheme	SU-MIMO	SU-MIMO	
SU dimension	1	1	
Antenna configuration at TRxP	8Tx, (8,4,2,1,1; 1,4)	8Rx, (8,4,2,1,1; 1,4)	
Antenna configuration at UE	2Rx, (1,1,2,1,1; 1,1)	2Tx, (1,1,2,1,1; 1,1)	
Scheduling	PF	PF	
Receiver	MMSE - IRC	MMSE - IRC	EUHT uses K-best but sufficient information regarding receiver model used is not given.

			5GIF has used MMSE as the receiver model for evaluation of EUHT candidate submissions.
Channel estimation	Non-ideal	Non-ideal	Refer to SER
Power control parameters	-	P0= -86, alpha = 0.8	
System configuration parameters			
TRxP number per site	3	Refer to SER	
Mechanic tilt	90° in GCS		
Electronic tilt	99° in LCS		
Handover margin (dB)	1		
Wrapping around method	Geographical distance-based wrapping		
Criteria for selection for serving TRxP	Maximizing RSRP where the digital beamforming is not considered		
Note: DT= Description Template, SP = Specification, SER- Self. Eval. Report in 5D/1300			

Table 4-40 Link Level parameters

Technical configuration Parameters	Downlink	Uplink	Remarks
Carrier frequency for evaluation	4 GHz	4 GHz	Refer to M.2412
Waveform	CP-OFDM	CP-OFDM	Refer to SER
Numerology	78.125 kHz SCS	78.125 kHz SCS	Refer to DT
Simulation bandwidth	20 MHz	20 MHz	Refer to M.2412
Channel model	TDL-iii	TDL-iii	Refer to SER
Scaled delay spread	363ns	363ns	
UE Speed	for indoor 3 km/h, for outdoor 30 km/h	-	
Antenna configuration at TRxP	8T	8R	
Antenna configuration at UE	2R	2T	
TXRU pattern at TRxP	0dBi Omni-directional	0dBi Omni-directional	
TXRU pattern at UE	0dBi Omni-directional	0dBi Omni-directional	
TCH Transmission mode	SU-MIMO	SU-MIMO	
TCH Modulation and coding	LDPC with code rate = 4/7, QPSK Repetition 12 in OFDM mode	LDPC with code rate = 4/7, QPSK Repetition 12 in OFDM mode	
Channel estimation	Non-Ideal	Non-Ideal	
CCH transmission scheme	56-bit payload includes CRC	-	
CCH Modulation and coding	TBCC with code rate = 1/2, QPSK Repetition 12	-	

Packet size	256 bits	256 bits
DRS configuration	2 symbols	2 symbols
Note: DT= Description Template, SP = Specification, SER- Self. Eval. Report in 5D/1300		

The downlink SINR distribution obtained from system level simulation is illustrated in the Figure 4.15. The 5%-tile SINR applied for link level simulation is -2.5 dB.

Figure 4.15 Downlink SINR distribution obtained from system level simulation

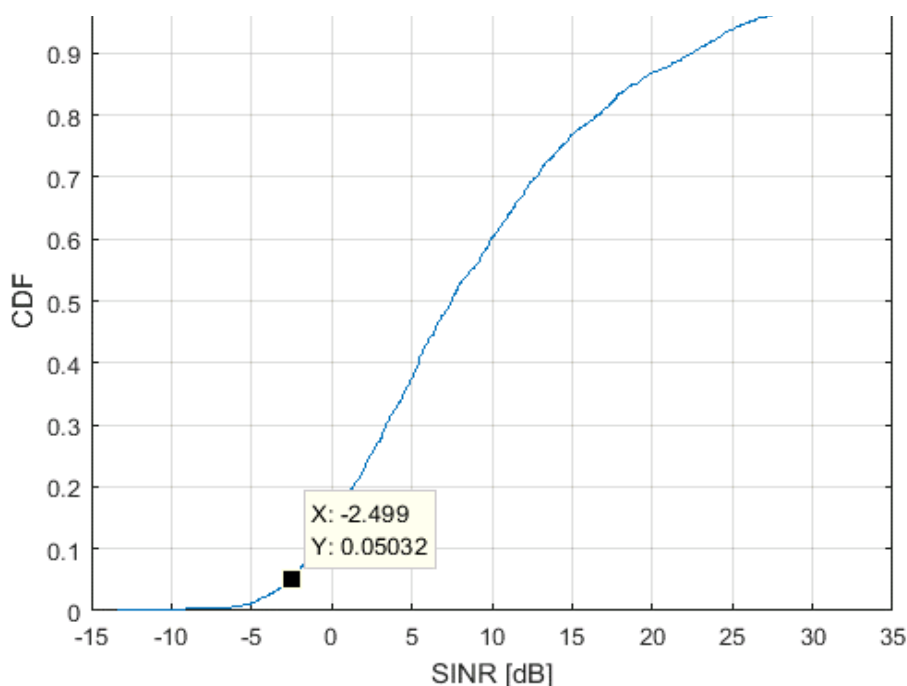

Based on the system level simulation and link level simulation, the evaluation result for downlink reliability is provided in Table 4-41.

Table 4-41 Downlink

Scheme and antenna configuration	Subcarrier Spacing [kHz]	Frame structure	Channel condition	Reliability	ITU Req.
8x2 SU-MIMO	78.125	DL:UL=2:1	NLOS	99.531%	99.999%

The uplink SINR distribution obtained from system level simulation is illustrated in the Figure 4n. The 5%-tile SINR applied for link level simulation is -8.0 dB.

Figure 4.16 Uplink SINR distribution obtained from system level simulation

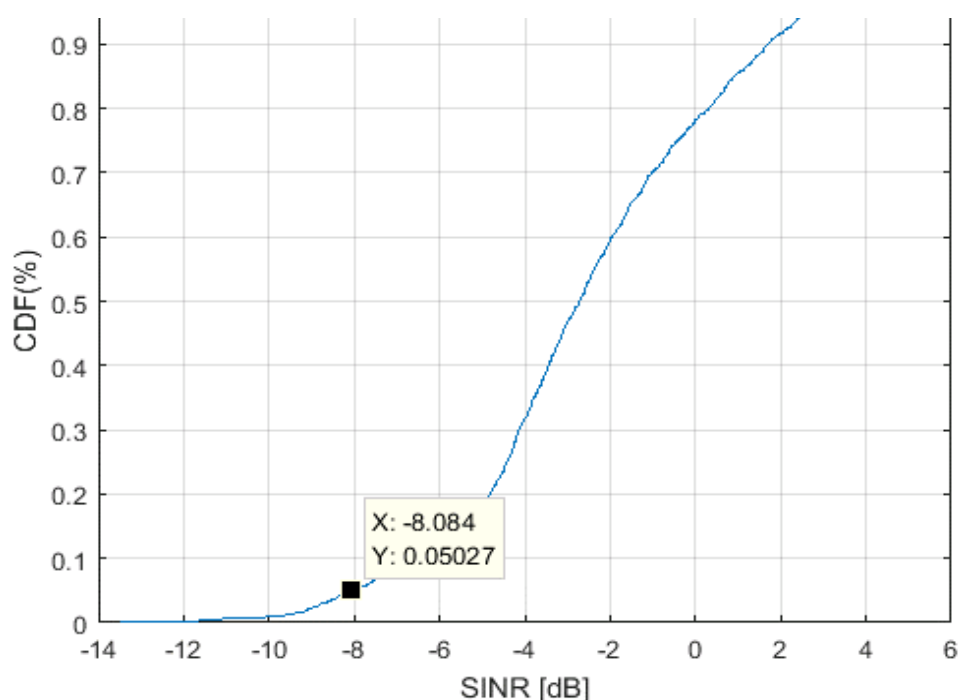

Based on the system level simulation and link level simulation, the evaluation result for uplink reliability is provided in Table 4-42.

Table 4-42 Uplink

Scheme and antenna configuration	Subcarrier Spacing [kHz]	Frame structure	Channel condition	Reliability	ITU Req.
2x8 SU-MIMO	78.125	DL:UL=2:1	NLOS	92.37%	99.999%

**5GIF Observations**

Antenna configuration used by EUHT has resulted in poor SINR values for users near the CAP and better SINR values for users farther to CAP which is evident from the results shown above. This has resulted in low reliability values and therefore EUHT technology is not able meet the reliability requirements for URLLC

**Evaluation Report**

Scenario	Performance Measure	ITU Requirements	5GIF Results	Conclusion Meets Requirement (Yes/No)	Remarks
			Eval. A		
URLLC	Reliability (%)	DL: 99.999%	DL: 99.531	No	Due to the antenna configuration chosen by EUHT and tilt angles considered the STAs close to the CAP which are supposed to receive high SINR and antenna
		UL: 99.999%	UL: 92.37	No	

					gain are experiencing very poor SINR and antenna gains. This has resulted in EUHT technology in not meeting the ITU minimum requirements.
--	--	--	--	--	---

### 4.3 Conclusion

5GIF evaluated the candidate technology EUHT IMT-2020/18 based on the available information provided by the proponent and the observations by WP5D in IMT-2020/27.

Overall, we found inconsistency in the information given in description templates and the specification provided in the submission. We also noticed inconsistency and lack of clarity on the assumptions used in the self-evaluation report of EUHT. Our detailed observations on the submissions are provided in Section 1.3.

As per our evaluation, the EUHT does not meet the requirements for spectral efficiency in eMBB scenario at least in the two test environments – eMBB Dense Urban and eMBB-InH.

EUHT also does not meet the minimum requirements for peak spectral efficiency, peak data rate, user experience data rate and Area Traffic capacity in eMBB

EUHT does not meet the minimum requirements of Reliability for URLLC scenario.

EUHT does not meet the requirements to satisfy the eMBB as well as URLLC scenarios.

## 5. Annexures

### A. Evaluation model for non-full buffer system level simulation for NB-IoT

#### A.1 Procedure and delay modeling

To evaluate NB-IoT, the procedure needs to be assumed for a packet transmission. Considering the packet arrival rate of a device is very sparse (1 message/day/device to 1 message/2 hours/device), it is appropriate to assume that the devices are within idle mode when an uplink message packet arrives.

In [2], it is shown that legacy procedure and small data transmission procedure are available. The small data transmission procedure is considered in this contribution for delay modelling. Besides, it is assumed that the devices are in non-initial state, that is, the SIB information is assumed to have been received by the devices. In this case, the SIB reception is ignored. This procedure is shown in Table 1. Based on the understanding of transmission delay, Step 1 to Step 4 is considered to be contributing to the total transmission delay. Besides, the following Step 5 and Step 6 are considered to be contributing to the DL or UL resource occupation, but do not contribute to the delay since the timer will stop when Step 4 finished.

Table 5 Early data transmission procedure of NB-IoT

NB-IoT		
Device		BS
	Step1: Sync + MIB	
	Step 2: PRACH Msg1	
	Step 3: NPDCCH + RAR (including UL grant)	
	Step 4: UL data transmission	
	Step 5: RRCEarlyDataComplete	
	Step 6: HARQ Ack	

#### A.2 Evaluation method of full system level simulation

Generally, the system level simulation should evaluate each packet's total delay  $t_{\text{packet}}$ . If  $t_{\text{packet}} > 10\text{s}$ , this packet is regarded as failed to be delivered to the destination receiver.

The total delay consists of the delays from Step 1 to 4,

$$t_{\text{packet}} = t_{\text{UL\_data}} + \sum_{i=1}^K t_i$$

where  $t_{\text{UL\_data}}$  is the UL data transmission time duration (for step 4), and  $t_1$ ,  $t_2$ , and  $t_3$  are the time delay for step 1~3, respectively.

Conventionally, the value of  $t_{\text{UL\_data}}$  can be well derived in system level simulation.

For derivation of  $t_1$ ,  $t_2$ , and  $t_3$ , a full implementation of these steps may result in high complexity simulation. Therefore a simplified model is needed for Step 1 to 3. In the following sub-sections, the considered delay models are presented.

#### A.3 Delay Modeling of Step 1: Sync + MIB

The step 1 delay is given by

$$t_1 = t_{SS} + t_{MIB}$$

where  $t_{SS}$  is the delay for synchronization, and  $t_{MIB}$  is the delay of MIB reception.

#### A.1.1 SYNCHRONIZATION DELAY

For NB-IoT, NPSS and NSSS are transmitted for the device to conduct synchronization. NPSS is transmitted in sub-frame 5 with 132 REs of each frame. NSSS is transmitted in sub-frame 9 with 132 REs of every other frames as illustrated in Figure 17.

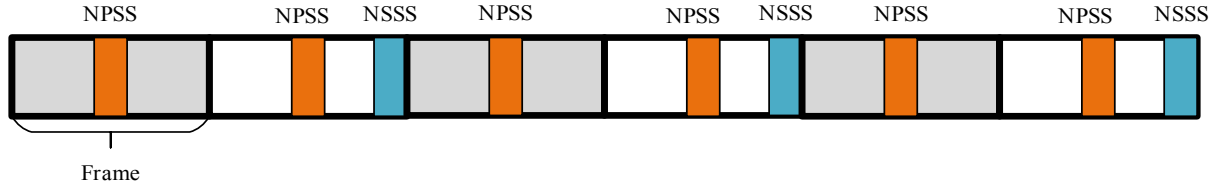

Figure 17 NPSS and NSSS for NB-IoT

Denote  $L_{NPSS}$  and  $L_{NSSS}$  as the repetition times needed to successfully accomplish primary synchronization and secondary synchronization, respectively. In this case, the synchronization delay is given by

$$\begin{aligned} t_{SS} &= t_{PSS} + t_{SSS} \\ t_{PSS} &= t_{NPSS_0} + (L_{NPSS} - 1) \times T_{PSS} \\ t_{SSS} &= t_{NSSS_0} + (L_{NSSS} - 1) \times T_{SSS} \end{aligned}$$

where  $t_{NPSS_0} = t_{NPSS} - t_0$  is the time interval between the nearest NPSS transmission at  $t_{NPSS}$ , and the packet arrival time,  $t_0$ ,  $T_{PSS} = 10\text{ms}$  is the transmission period of NPSS;  $t_{NSSS_0} = t_{NSSS} - t_0$  is the time interval between the nearest NSSS transmission at  $t_{NSSS}$ , and the packet arrival time,  $t_0$ , and  $T_{SSS} = 20\text{ms}$  is the transmission period for NSSS.

The value of  $L_{NPSS}$  and  $L_{NSSS}$  can be determined by DL SINR, based on link level simulation using TDL-iii channel model. The corresponding value of  $L_{NPSS}/L_{NSSS}$  for a given SINR can be determined according to the 90th percentile point successful detection of NPSS/NSSS (under this SINR value) as shown in the following mapping table.

#### A.1.2 PBCH RECEIVING DELAY

NPBCH (for MIB) is transmitted in sub-frame 0 in every radio frame with 100 REs on anchor-PRB with at most 64 sub-frame combination as illustrated in Figure 18

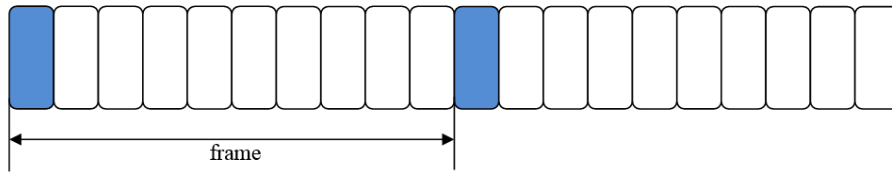

Figure 18 NPBCH for NB-IoT

Denote  $L_{NPBCH}$  as the repetition times for correctly receiving NPBCH. Hence, the receiving PBCH delay is given by

$$t_{npbch} = t_{NPBCH_0} + (L_{NPBCH} - 1) \times T_{NPBCH}$$

where  $t_{NPBCH_0} = t_{NPBCH} - t_0$  is the time interval between the nearest NPBCH transmission at  $t_{NPBCH}$ , and the synchronization end time,  $t_0$ ,  $T_{NPBCH} = 10\text{ms}$  is the transmission period of NPBCH.

The value of  $L_{NPBCH}$  can be determined by DL SINR, based on link level simulation using TDL-iii channel model (with QPSK, coding rate of 0.25, and code block size of 50bit). The corresponding SNR threshold for a given  $L_{NPBCH}$  would guarantee larger than 90% successful reception ratio with  $L_{NPBCH}$  times repetition of NPBCH reception.

### A.4 Delay Modeling of Step 2: PRACH Msg1



For PRACH delay model, it is dependent on two aspects. One is the number of collisions encountered by the device,  $n_{\text{collision}}$ . The other aspect is the time duration,  $t_{\text{PRACH}}$ , for correctly receiving PRACH without collision. The latter is depending on UL SINR. Therefore the PRACH delay is given by

$$t_2 = f_2(n_{\text{collision}}, t_{\text{PRACH}})$$

If collision happens during the PRACH transmission, all of the collided PRACH transmissions are assumed to be failed, and another round of PRACH transmission for the collided UEs is needed.

For NB-IoT, the UEs will transmit PRACH according to its CE level. The CE level is determined by its RSRP (see TS36.331). For UEs in a specific CE level, the time domain resource for PRACH could be configured according to TS36.331 by the transmission periodicity, transmission duration (or repetition times), and the transmission start time (within the period). If the three CE levels share the same PRACH frequency resource, the UEs with lower CE level could not use the PRACH resource that is overlapped with higher CE level. One illustration is shown in Figure 19.

Device starts the PRACH transmission at available transmission time according to its CE level as shown in colored box in Figure 19, and randomly selects one PRACH channel among the available number of channels (assumed to be 24 in this simulation).

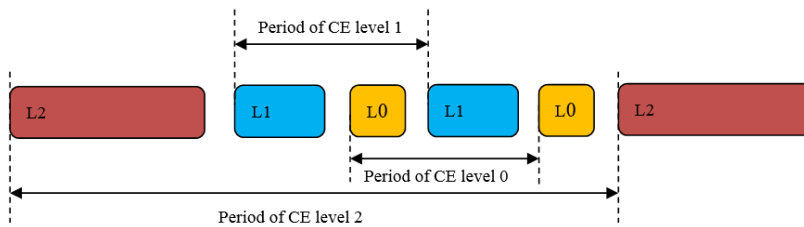

Figure 19 Illustration of PRACH configuration for three CE levels (PRACH shares the same frequency resource)

The NPRACH of each CE level has its own parameter  $n_{\text{prach-Periodicity-r14}}$  and  $n_{\text{prach-StartTime-r14}}$  to decide the NPRACH candidate opportunity (see Section 6.7.3 in TS36.331). And the corresponding SNR threshold is given by link level simulation using TDL-iii channel, with the guarantee of 90% successful reception ratio of NPRACH. The example configuration of NPRACH resource is shown as in Table .

Table 6 Example NPRACH configuration for each CE level

Coverage Enhancement level	Repetition times of NPRACH transmission	Transmission Duration $t_{\text{PRACH duration}}$	Periodicity	NPRACH start time
CE Level 0	2	11.2ms	40ms	8ms
CE Level 1	8	44.8ms	80ms	32ms
CE Level 2	32	179.2ms	1280ms	8ms

For a given UE, it is assumed that its CE level is determined by DL RSRP in the simulation. Meanwhile, a full buffer UL SINR is calculated for this UE to determine whether its PRACH could be detected by BS. If its UL SINR is lower than the corresponding CE level SNR threshold, it is assumed that BS could not detect its PRACH signal, and the UE could not receive any response from BS, then this UE would continue to send PRACH signal until  $\text{maxNumPreambleAttemptCE}$  times (See TS 36.331), after that UE should switch its CE level downward, and then starts another round of PRACH transmission.

If only one device occupies the channel at that time, it is assumed that BS could receive the PRACH correctly. If multiple UEs within the same CE level start the PRACH transmission at the same time (say  $t_0$ ), and all of them occupies the same sub-carrier (channel) at  $t_0$ , these UEs are collided, and their PRACH reception at BS side would be failed.

When collision occurs, a backoff mechanism is used to avoid further collision to next transmission (see Section 5.1.5 in TS36.321). The backoff length (until the next PRACH transmission) consists of two parts: one is the backoff window with length of  $t_{\text{backoff}}$ , which is a random value between  $\{0, T_{\text{window}}\}$  ms;

the other part is the RAR window with the minimum length of  $2 \times T_{PDCCCH}$ , where  $T_{PDCCCH}$  is the transmission period of NPDCCH in Step 3. In this case, the total latency for PRACH is given by

$$t_{PRACH} = \sum_{i=1}^{n_{collision}+1} (t_{PRACH\_0\_i} + t_{PRACH\_duration\_i} + t_{backoff\_i} + 2 \times T_{PDCCCH})$$

where  $t_{PRACH\_0\_i}$  is from the time when the device is ready to send PRACH to the time of the nearest PRACH transmission opportunity for this device,  $t_{PRACH\_i}$  is the transmission duration of the  $i$ -th PRACH transmission of the device (depending on UL SINR;  $t_{PRACH\_duration\_i} = L_{PRACH} \times T_{PRACH}$ , where  $L_{PRACH}$  is the NPRACH repetition time required by UL SINR, and  $T_{PRACH}$  is the interval of preamble format 0),  $t_{backoff\_i}$  is the window length of the  $i$ -th back off which is randomly selected in  $(0, T_{window})$ ms, while it is 512ms in the simulation, where the value of  $T_{window}$  could be configured as in Table 7.2-2 in TS 36.321, and  $T_{PDCCCH}$  is the period of common search space (CSS), it is configured as 24ms, 48ms and 96ms for each CE level respectively, and  $n_{collision} \geq 0$  is number of collisions encountered by the device that is provided by the system level simulation.

Table 7 Backoff Parameter values for NB-IoT

Index	Backoff Parameter value (ms)
0	0
1	256
2	512
3	1024
4	2048
5	4096
6	8192
7	16384
8	32768
9	65536
10	131072
11	262144
12	524288
13	Reserved
14	Reserved
15	Reserved

#### A.5 Delay Modeling of Step 3: NPDCCH + RAR (including UL grant)

For NB-IoT, the Step 3 transmission (downlink) consists of NPDCCH transmission and RAR transmission through PDSCH,

$$t_3 = t_{NPDCCH} + t_{RAR}$$

where  $t_{NPDCCH}$  is the delay for correctly receiving NPDCCH, and  $t_{RAR}$  is the delay for correctly receiving RAR.

##### A.5.1 SCHEDULING SCHEME OF NPDCCH AND RAR

The scheduling of NPDCCH and RAR (transmitted on NPDSCH) are based on system level simulation. For a given time instance, NPDCCH is assumed to have higher scheduling priority over RAR transmission. However, once RAR transmission starts, it is assumed that this RAR transmission has the highest scheduling priority at that time instance.

##### A.5.2 NPDCCH DELAY

The NPDCCH transmission delay for a specific device consists of two parts, i.e., the scheduling delay and the transmission duration,

$$t_{NPDCCH} = t_{NPDCCH\_0} + (L_{NPDCCH} - 1) \times TTI$$

where  $t_{NPDCCH\_0} = t_{NPDCCH\_sche} - t_0$  is the time interval between the time when the available NPDCCH resource exist for the specific device at  $t_{NPDCCH\_sche}$ , and the PRACH end time,  $t_0$ , the available PDCCH means a candidate PDCCH resource which is not scheduled for other UEs,  $L_{NPDCCH}$  is the repetition times for correctly receiving NPDCCH, and  $TTI=1ms$ . The value of  $t_{NPDCCH\_sche}$  is related to the scheduling scheme of NPDCCH and RAR.

If multiple devices which belong to the same CE level request PDCCH transmission at a specific time instance, they may share the NPDCCH resource. In this case, the value of  $L_{NPDCCH}$  for device  $k$  will be aligned with the device that requests the largest value of  $L_{NPDCCH}$ . For a given CE level,  $R_{MAX}$  and  $G$  are configured to determine the period of common searching space of this CE level, where  $T_{PDCCH} = G * R_{MAX}$  as illustrated in Figure 20. UE should monitor each PDCCH candidate within a set of repetition  $\{ R_{MAX}/8, R_{MAX}/4, R_{MAX}/2, R_{MAX} \}$ . So the  $L_{NDCCH}$  should be selected in this repetition set.

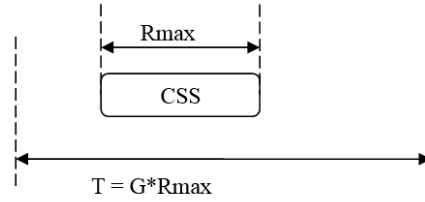

Figure 20 Example of Common Searching Space

The exact value of  $L_{NDCCH}$  can be determined by DL SINR, based on link level simulation using TDL-iii channel model. The corresponding SNR threshold for a given  $L_{NDCCH}$  would guarantee larger than 90% successful reception ratio with  $L_{NDCCH}$  times repetition of NPDCCH reception. It is noted that NPDCCH is transmitted using QPSK, coding rate of 0.128, and code block size of 39bit for the case of using 12 sub-carriers.

#### A.5.3 RAR DELAY

The RAR transmission delay for a specific device consists of two parts, i.e., the scheduling delay and the transmission duration,

$$t_{RAR} = t_{NPDSCH\_0} + (L_{NPDSCH} - 1) \times T_{RAR}$$

where  $t_{NPDSCH\_0} = t_{NPDSCH\_sche} - t_0$  is the time interval between the available NPDSCH transmission for the specific device at  $t_{NPDCCH\_sche}$ , and the NPDCCH end time,  $t_0$ , the available NPDSCH means an unused DL resource after time  $t_0$ ,  $L_{NPDSCH}$  is the repetition times for correctly receiving NPDSCH, and  $T_{RAR}$  is the transmission duration for one RAR packet. The value of  $t_{NPDSCH\_sche}$  is related to the scheduling scheme of NPDCCH and RAR.

For the case of BS scheduling RAR for multiple UEs simultaneously, the RAR packet size would be  $nS$  where  $S=56bits$  is the size of a single RAR, and  $n$  denotes the number of scheduled devices. The value of  $L_{NPDSCH}$  and the MCS for device  $k$  will be aligned with the device which requests the largest value of  $L_{NPDSCH}$ , and it could be derived from simulation according to RAR packet size and DL SINR, while DL SINR could be derived from DL wideband SINR.

For NB-IoT, one RAR transmission duration is derived by

$$t_{RAR} = \frac{nS}{SE(MCS, OH) \times 180kHz} \times 1000$$

where  $n$  is the number of scheduled devices for RAR transmission,  $S=56bit$  is the size of RAR for one device,  $SE$  is the expected spectral efficiency (bps/Hz) that is related to  $MCS$  and overhead  $OH$ .  $MCS$  is selected based on DL PDSCH SINR, which can be derived from DL wideband SINR. When multiple devices are scheduled ( $n>1$ ), the MCS is selected based on the device that experiences the worst SINR.

#### A.6 Delay Modeling of Step 4: UL data

The UL data transmission is fully modeled in the system level simulation as in conventional system level simulation. UL data contains two parts, RRC connection request message (88bits) and UL traffic packet (256bits), so the total packet size is 344bits. To facilitate the system level simulation, only single-tone is used for scheduling, while UL data transmission is based on MAC scheduling according to UL resource utilization condition and UL SINR of devices. The transmission delay of step 4 could be depicted as the following.

$$t_{UL\_data} = \sum_{i=1}^{N+1} (t_{SCHED\_i} + t_{PUSCH\_duration\_i})$$

where  $t_{SCHED\_i}$  is the scheduling delay for the  $i$ -th transmission,  $t_{PUSCH\_duration\_i}$  is the transmission duration for  $i$ -th PUSCH transmission for the specific device.  $N$  is the retransmission times for UL data transmission. These values are derived by system level simulation.

#### A.7 DL and UL resource occupation model for Step 5 and Step 6

Since Step 5 RRC early data complete message and Step 6 HARQ Ack are after the UL data reception, the transmission delay should not be taken into consideration, but both steps would occupy a few DL and UL resource which may impact the simulation result. So the resource occupation of Step 5 and Step 6 are modeled in the system level simulation.

##### A.7.1 DL RESOURCE OCCUPATION FOR STEP 5: RRC EARLY DATA COMPLETE

This model is similar to the MSG2 transmission model (Step 3). It contains two parts, PDCCH occupation and PDSCH occupation. BS should assign PDCCH and PDSCH resource to this step according to the DL SINR to the device. Since the PDCCH of this message is masked with temporary C-RNTI, so the PDCCH would be transmitted in common searching space as depicted in Section 0, and the  $L_{NPDCCH}$  should be derived based on DL SINR same as MSG2. Besides, the  $L_{NPDSCH}$  should be derived based on DL SINR and the message size. Then the DL resource occupied by transmission of *RRCEarlyDataCompele* can be determined, and it will reduce the DL resource for transmission of Step 3.

##### A.7.2 UL RESOURCE OCCUPATION FOR STEP 6: HARQ ACK

NB-IoT uses PUSCH format 2 to transmit HARQ Ack, and each resource unit is 2ms length for 15kHz sub-carrier and it has only 1 bit data. It is assumed that BS determines the UL resource occupation for a specific device according to its UL SINR, and the HARQ Ack is assumed to be error free. The UL resource occupied by this step will reduce the UL resource for Step 4.

## B. System-level simulation assumptions of mMTC

### B.1. Simulation assumption for mMTC

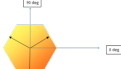
Urban Macro - mMTC	Parameter
Carrier frequency for evaluation	700 MHz
ISD	Config A: 500m Config B: 1732m
BS antenna height	25 m
Total transmit power per TRxP	43 dBm on 180kHz
Device power class	23 dBm
Inter-site distance	1732 m
Number of antenna elements per TRxP	16 Tx/Rx, (M,N,P,Mg,Ng) = (8,1,2,1,1), (dH,dV) = (N/A, 0.8) $\lambda$ +45°, -45° polarization
Number of TXRU per TRxP	2TXRU, (Mp,Np,P,Mg,Ng) = (1,1,2,1,1)
Number of device antenna elements	1Tx/Rx 0° polarization
Number of TXRU per device	1TXRU
Device deployment	80% indoor, 20% outdoor Randomly and uniformly distributed over the area
Device mobility model	Fixed and identical speed  v  of all UEs of the same mobility class, randomly and uniformly distributed direction.
Device speeds of interest	3 km/h for indoor and outdoor
Inter-site interference modeling	Explicitly modelled
BS noise figure	5 dB
Device noise figure	7 dB
BS antenna element gain	8 dBi
Device antenna element gain	0 dBi
Thermal noise level	-174 dBm/Hz
Traffic model	With layer 2 PDU (Protocol Data Unit) message size of 32 bytes: 1 message/2 hours/device Packet arrival follows Poisson arrival process
Device antenna height	1.5 m
Channel model	Channel model A Channel model B
TRxP number per site	3
Mechanic tilt	90° in GCS (pointing to horizontal direction)
Electronic tilt	Config A: 99° in LCS Config A: 93° in LCS
TRxP boresight	30 / 150 / 270 degrees 
UT attachment	Based on RSRP from port 0
Wrapping around method	Geographical distance based wrapping
Minimum distance of TRxP and device	$d_{2D, \min} = 10\text{m}$
Polarized antenna model	Model-2 in TR36.873

### B.2 Simulation assumption for NB-IoT

Urban Macro – NB-IoT	Parameter
Simulation bandwidth	180 kHz
Sub-carrier spacing for PDCCH, PDSCH	15 kHz
Sub-carrier spacing for PUSCH	15 kHz

PRACH	90kHz with 24 sub-carriers (channels) in 180 kHz BW, 3.75kHz sub-carrier spacing for PRACH Back off window $T_{window}=512ms$
UL DMRS	2 symbols per 14 OFDM symbols
PUSCH scheduling unit	Single tone (15kHz)
NPDCCH period $T_{PDCCH}$	CE level 0: 24ms, CE Level 1: 48ms CE level 2: 96ms
Power control	ISD 1732m: Alpha = 1, P0 = -115.8 dBm on 15kHz ISD 500m: Alpha = 1, P0 = -100 dBm on 15kHz

### B.3 Simulation assumption for NR

Urban Macro – NR	Parameter
Simulation bandwidth	5MHz
Sub-carrier spacing for PDCCH, PDSCH	15 kHz
Sub-carrier spacing for PUSCH	15 kHz
UL DMRS	12 symbols per RB
PUSCH scheduling unit	180kHz
Simulation bandwidth	5 MHz
Power control	ISD 1732m: Alpha = 1, P0 = -113 dBm on 180kHz ISD 500m: Alpha = 1, P0 = -103 dBm on 180kHz

### C. Link level simulation assumption for mMTC

	NB-IoT Parameter	NR Parameter
Simulation bandwidth	15kHz	180kHz
Sub-carrier spacing	15 kHz	15 kHz
Modulation order	$\pi/2$ BPSK / $\pi/4$ QPSK	QPSK/16QAM
Number of Resource unit	2,3,4,5,6,8,10	-
Number of TTI	-	1
Number of repetition	1,2,4,8,16	-
Channel model	TDL-iii	
Delay spread	363ns	
TBS	256	40,48,64,80,96,144,152,168,184,208,240,256
Channel estimation	Realistic	

D. SINR distribution of full buffer system level simulation (mMTC evaluation)

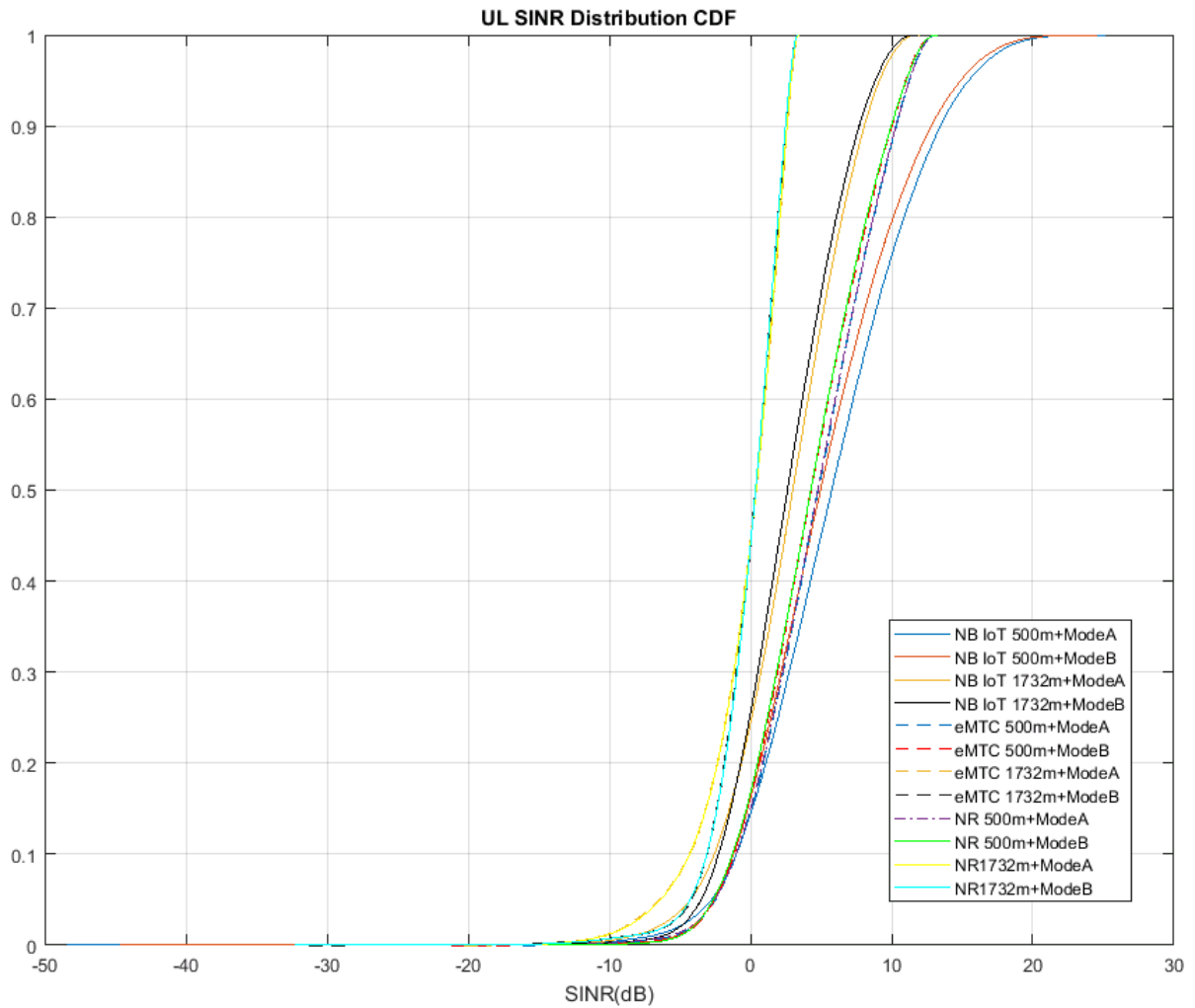

Figure 21 SINR distribution of NB-IoT and NR for config A/B with Channel model A/B



E. Spectrum efficiency from link-level simulation (mMTC Evaluation)

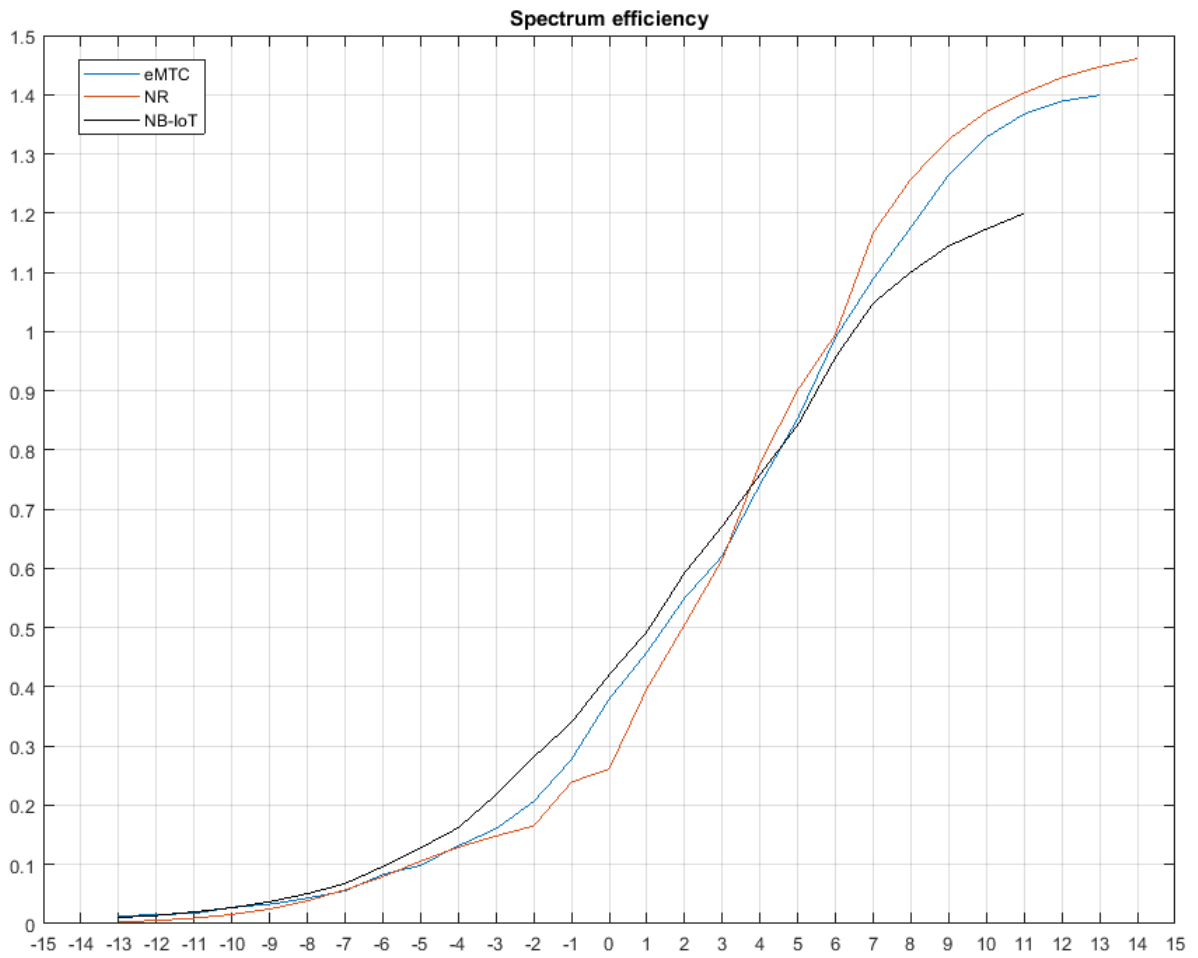

Figure 22 Spectrum efficiency of NB-IoT and NR

## F. CDF for ZoD spread for LOS and NLOS (mobility evaluation)

The CDF of mean value of ZoD spread for LOS and NLOS for Rural and Dense Urban test environment are plotted from Figure A1-1 to Figure A1-3, respectively.

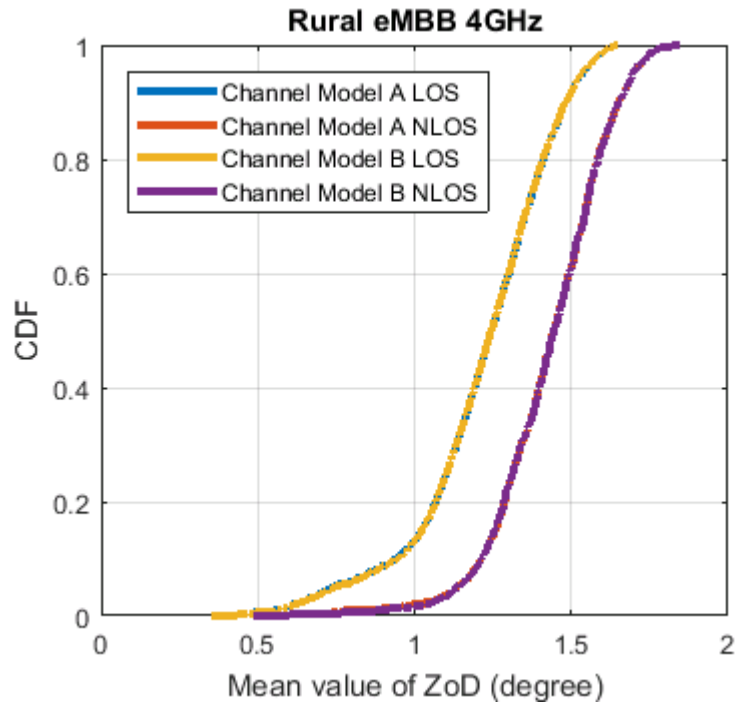

Figure F-1 Mean value of ZoD (degree) for Rural (4 GHz)

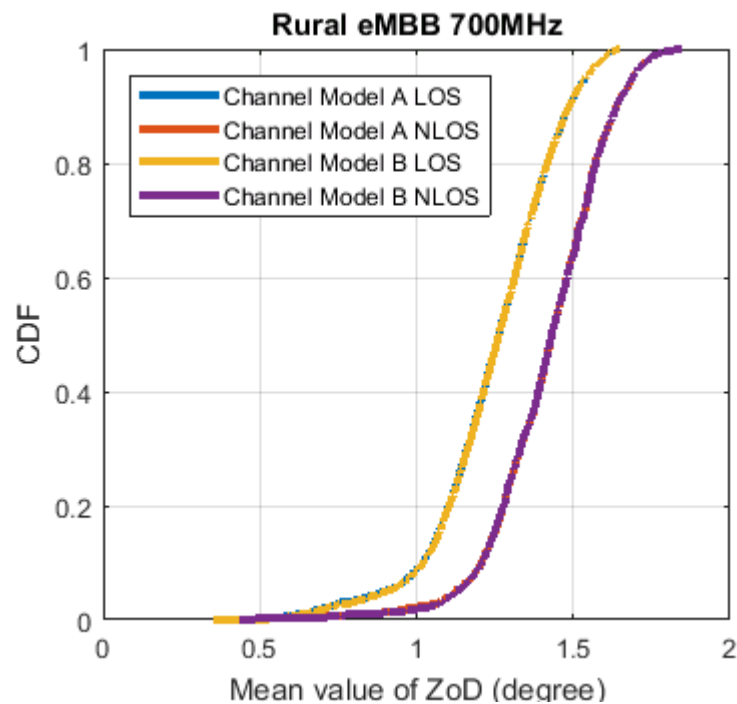

Figure F-2 Mean value of ZoD (degree) for Rural (700 MHz)

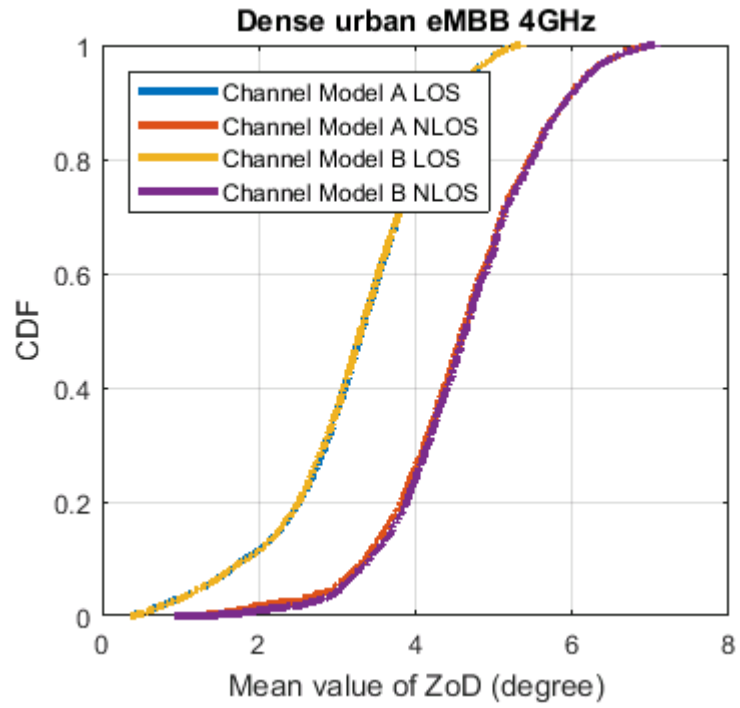

Figure F-3 Mean value of ZoD (degree) for Dense Urban (4 GHz)

## G. Simulation assumption of SLS part for mobility evaluation

The simulation assumption of system level part for mobility evaluation is listed in Table H-1.

Table G-1. Simulation assumptions of SLS

	Indoor Hotspot – eMBB	Dense urban - eMBB	Rural - eMBB
Evaluation configuration	Configuration A, Configuration B	Configuration A	Configuration A, Configuration B
Carrier frequency for evaluation	4 GHz	4 GHz	Configuration A :700 MHz Configuration B : 4 GHz
Multiple access	OFDMA	OFDMA	OFDMA
Duplexing	FDD, TDD	FDD, TDD	FDD, TDD
Transmission scheme	UL SIMO	UL SIMO	UL SIMO
BS antenna height	3m	25 m	35 m
Total transmit power per TRxP	21 dBm for 10 MHz bandwidth	41 dBm for 10 MHz bandwidth	46 dBm for 10 MHz bandwidth
UE power class	23 dBm	23 dBm	23 dBm
Percentage of high loss and low loss building type	-	20% high loss, 80% low loss (applies to Channel model B)	100% low loss (applies to Channel model B)
Inter-site distance	20 m	200 m	1732 m
Number of antenna elements per TRxP	32 Tx/Rx, (M,N,P,Mg,Ng) = (4,4,2,1,1), (dH,dV) = (0.5, 0.5) $\lambda$ +45°, -45° polarization	64 Tx/Rx, (M,N,P,Mg,Ng) = (8,4,2,1,1), (dH,dV) = (0.5, 0.8) $\lambda$ +45°, -45° polarization	32 Tx/Rx, (M,N,P,Mg,Ng) = (8,2,2,1,1), (dH,dV) = (0.5, 0.8) $\lambda$ +45°, -45° polarization
Number of TXRU per TRxP	8TXRU, (Mp,Np,P,Mg,Ng) = (1,4,2,1,1)	8TXRU, (Mp,Np,P,Mg,Ng) = (1,4,2,1,1)	4TXRU, (Mp,Np,P,Mg,Ng) = (1,2,2,1,1)
Number of UE antenna elements	1Tx/Rx, (M,N,P,Mg,Ng) = (1,1,1,1,1)	1Tx/Rx, (M,N,P,Mg,Ng) = (1,1,1,1,1)	1Tx/Rx, (M,N,P,Mg,Ng) = (1,1,1,1,1)
Device deployment	100% indoor Randomly and uniformly distributed over the area	80% indoor, 20% outdoor (in car) Randomly and uniformly distributed over the area under Macro layer	50% indoor, 50% outdoor (in car) Randomly and uniformly distributed over the area
UE speeds of interest	10 km/h	30 km/h;	120 km/h;500km/h;
Traffic model	Full buffer	Full buffer	Full buffer
Simulation bandwidth	For FDD: 10 MHz For TDD: 20 MHz	For FDD: 10 MHz For TDD: 20 MHz	For FDD: 10 MHz For TDD: 20 MHz
UE density	10 UEs per TRxP	10 UEs per TRxP	10 UEs per TRxP
UE antenna height	1.5 m	Outdoor UEs: 1.5 m Indoor UTs: 3(nfl - 1) + 1.5; nfl ~ uniform(1,Nfl) where Nfl ~ uniform(4,8)	1.5 m
Channel model variant	Alt. 1: Channel model A Alt. 2: Channel model B	Alt. 1: Channel model A Alt. 2: Channel model B	Alt. 1: Channel model A Alt. 2: Channel model B
TRxP number per site	1 or 3	3	3
Mechanic tilt	For 1 TRxP per site:180° in GCS (pointing to the ground) For 3 TRxPs per site: 110°	90° in GCS (pointing to horizontal direction)	90° in GCS (pointing to horizontal direction)
Electronic tilt	90° in LCS	105° in LCS	100° in LCS
Handover margin (dB)	1	1	1
TRxP boresight	For 1 TRxP per site:- For 3 TRxP per site: 30 / 150 / 270 degrees	30 / 150 / 270 degrees	30 / 150 / 270 degrees
UT attachment	Based on RSRP (formula (8.1-1) in TR36.873) from port 0	Based on RSRP (formula (8.1-1) in TR36.873) from port 0	Based on RSRP (formula (8.1-1) in TR36.873) from port 0
Wrapping around method	No wrapping around	Geographical distance based wrapping	Geographical distance based wrapping
Minimum distance of TRxP and UE	$d_{2D\_min}=0m$	$d_{2D\_min}=10m$	$d_{2D\_min}=10m$
Polarized antenna model	Model-2 in TR36.873	Model-2 in TR36.873	Model-2 in TR36.873
Power control parameters	$\alpha=0.6$ , $P_0 = -60$ dBm	$\alpha=0.9$ , $P_0 = -86$ dBm	For 700 MHz : $\alpha=0.8$ , $P_0 = -76$ dBm For 4 GHz : $\alpha=0.6$ , $P_0 = -60$ dBm
Numerology	For FDD: One slot with 15 kHz SCS For TDD: One slot with 30 kHz SCS	For FDD: One slot with 15 kHz SCS For TDD: One slot with 30 kHz SCS	For 700 MHz: - 120 km/h: one slot with 15 kHz SCS - 500 km/h: one slot with 30 kHz SCS For 4 GHz: - 120 km/h: one slot with 30 kHz SCS - 500 km/h: one slot with 60

			kHz SCS
Scheduling	PF	PF	PF
Receiver	MMSE-IRC	MMSE-IRC	MMSE-IRC
Pre-processing calculation	SINR Aligned with Section 2.1.1 in R1-1805643	Aligned with Section 2.1.1 in R1-1805643	Aligned with Section 2.1.1 in R1-1805643

## H. Simulation assumption of LLS part for mobility evaluation

The simulation assumption of link level part for mobility evaluation is listed in Table A3-1.

Table A3-1. Simulation assumptions of LLS

	Indoor Hotspot – eMBB	Dense urban - eMBB	Rural – eMBB
Carrier frequency for evaluation	4 GHz	4 GHz	Configuration A :700 MHz; Configuration B : 4 GHz
RIT	NR	NR	NR
Waveform	CP-OFDM	CP-OFDM	CP-OFDM
Duplexing	FDD, TDD	FDD, TDD	FDD, TDD
TDD frame structure	DDDSU	DDDSU	DDDSU
Evaluated service profiles	Full buffer best effort	Full buffer best effort	Full buffer best effort
Simulation bandwidth	10 MHz	10 MHz	10 MHz
Number of users in simulation	1	1	1
Link-level Channel model	NLOS: CDL-i LOS: CDL-iv	NLOS: CDL-iii LOS: CDL-v	NLOS: CDL-iii LOS: CDL-v
UE speed	10 km/h	30 km/h	120 km/h, 500 km/h
Subcarrier spacing	For FDD: 15 kHz For TDD: 30 kHz	For FDD: 15 kHz For TDD: 30 kHz	For 700 MHz: - 120 km/h: 15 kHz - 500 km/h: 30 kHz For 4 GHz: - 120 km/h: 30 kHz - 500 km/h: 60 kHz
Symbols number per slot	14	14	14
Antenna configuration at TRxP	8R, (4,4,2,1,1; 1,4)	8R, (8,4,2,1,1; 1,4)	4R, (8,2,2,1,1; 1,2)
Antenna configuration at UE	1T, (1,1,1,1,1; 1,1)	1T, (1,1,1,1,1; 1,1)	1T, (1,1,1,1,1; 1,1)
TXRU pattern at TRxP	Option 1: 0dBi Omni-directional	Option 1: 0dBi Omni-directional	Option 1: 0dBi Omni-directional
TXRU pattern at UE	Option 1: 0dBi Omni-directional	Option 1: 0dBi Omni-directional	Option 1: 0dBi Omni-directional
Transmission mode	SIMO	SIMO	SIMO
Transmission rank	Rank 1	Rank 1	Rank 1
UL precoder	-	-	-
TRxP receiver type	MMSE-IRC	MMSE-IRC	MMSE-IRC
Channel estimation	LMMSE	LMMSE	LMMSE
Number of subcarriers per PRB	12	12	12
Data allocation	14 symbol slots, with 12 RB allocated	14 symbol slots, with 12 RB allocated	14 symbol slots, with 12 RB allocated
Channel coding scheme	LDPC	LDPC	LDPC
Link adaptation	Yes	Yes	Yes
HARQ	Max 4 HARQ transmissions	Max 4 HARQ transmissions	Max 4 HARQ transmissions
DMRS configuration	2 symbol DMRS (front loaded and one additional) with configuration type 2, no FDM with data and full power utilization in DMRS symbols	2 symbol DMRS (front loaded and one additional) with configuration type 2, no FDM with data and full power utilization in DMRS symbols	- For 4GHz 500km/h: 4 symbol DMRS (front loaded and 3 additional) with configuration type 2, no FDM with data and full power utilization in DMRS symbols - Others: 2 symbol DMRS (front loaded and one additional) with configuration type 2, no FDM with data and full power utilization in DMRS symbols
Other overhead	- SRS: 2 symbols per 5 slots. For TDD, the 2 symbols are the 2 uplink symbols in S sub-frame - PUCCH :2 RB in 10MHz bandwidth	- SRS: 2 symbols per 5 slots. For TDD, the 2 symbols are the 2 uplink symbols in S sub-frame - PUCCH :2 RB in 10MHz bandwidth	- SRS: 2 symbols per 5 slots. For TDD, the 2 symbols are the 2 uplink symbols in S sub-frame - PUCCH :2 RB in 10MHz bandwidth

## I. SLS Results:

## I.1 Pathloss Model

### Rural - eMBB

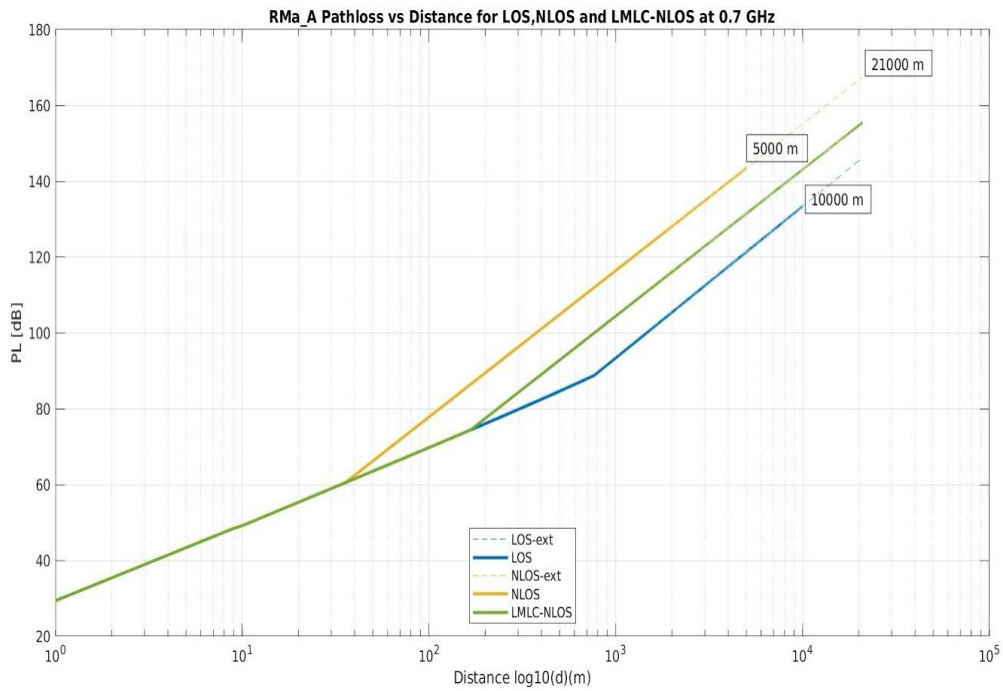

### Dense Urban - eMBB

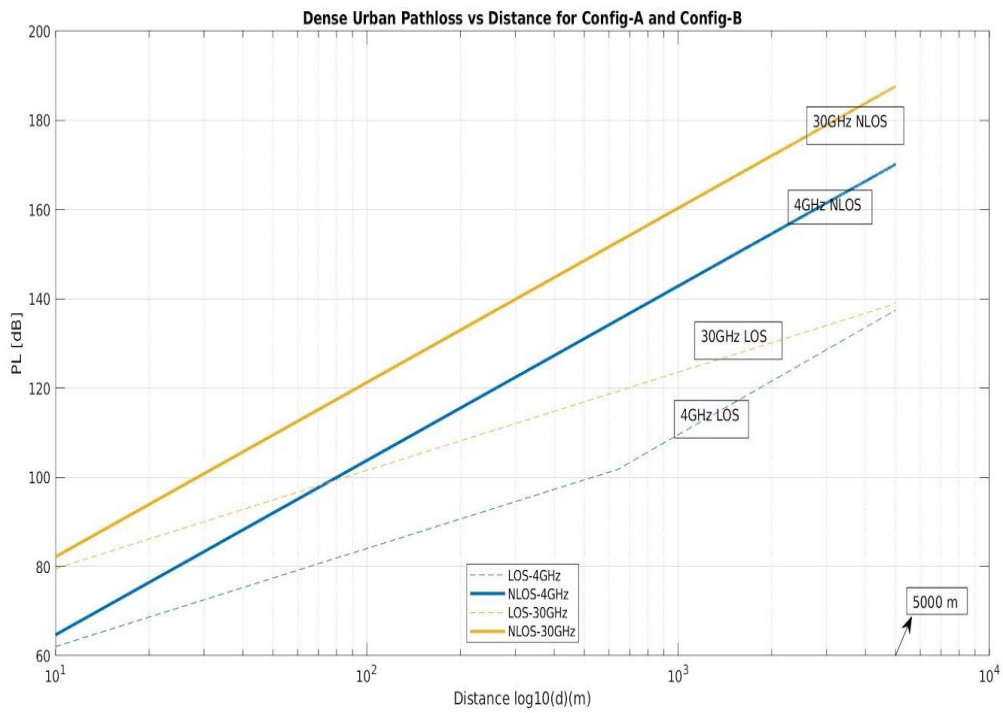

### Indoor Hotspot -eMBB

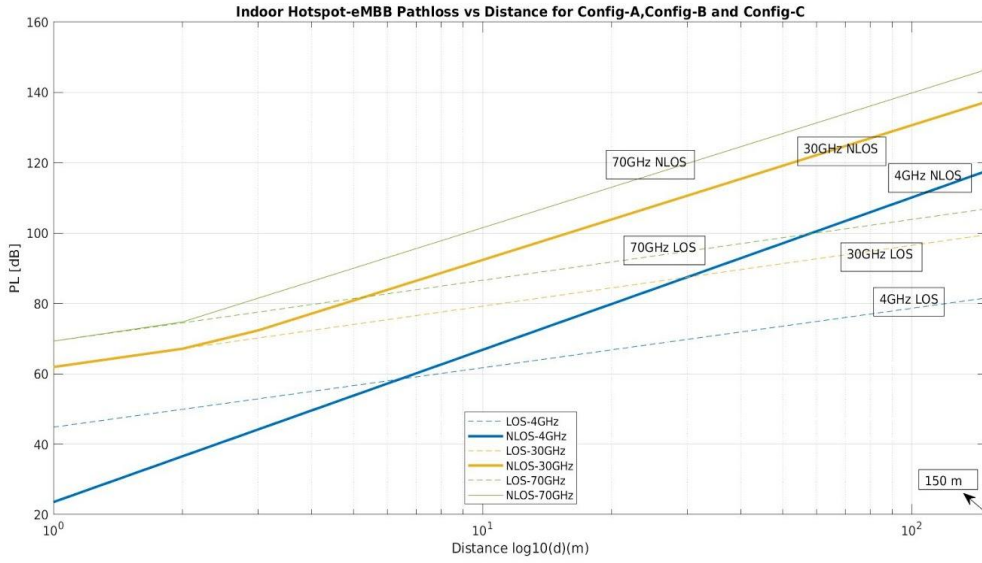

Antenna Pattern  
Rural - eMBB

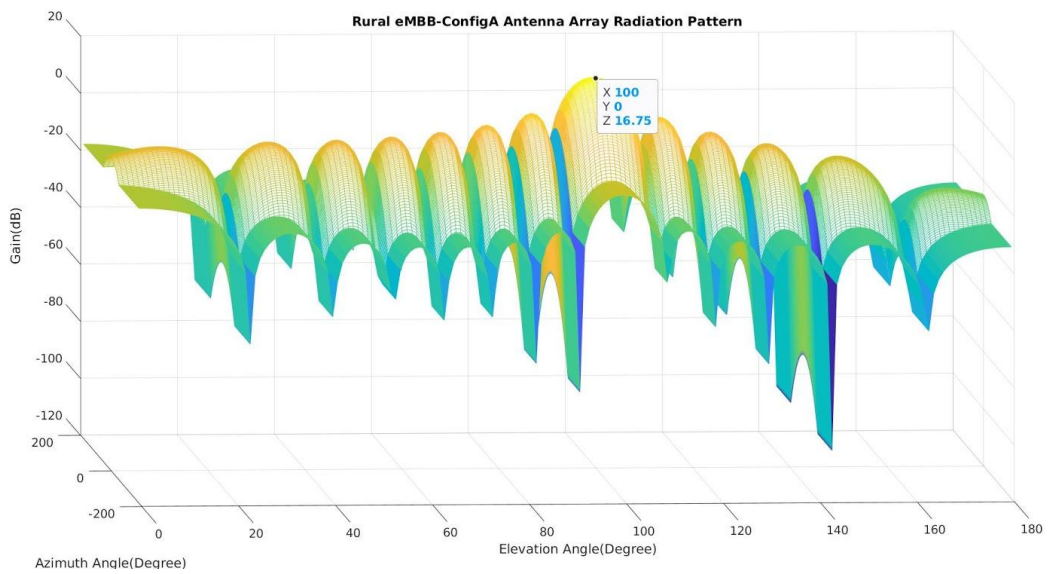
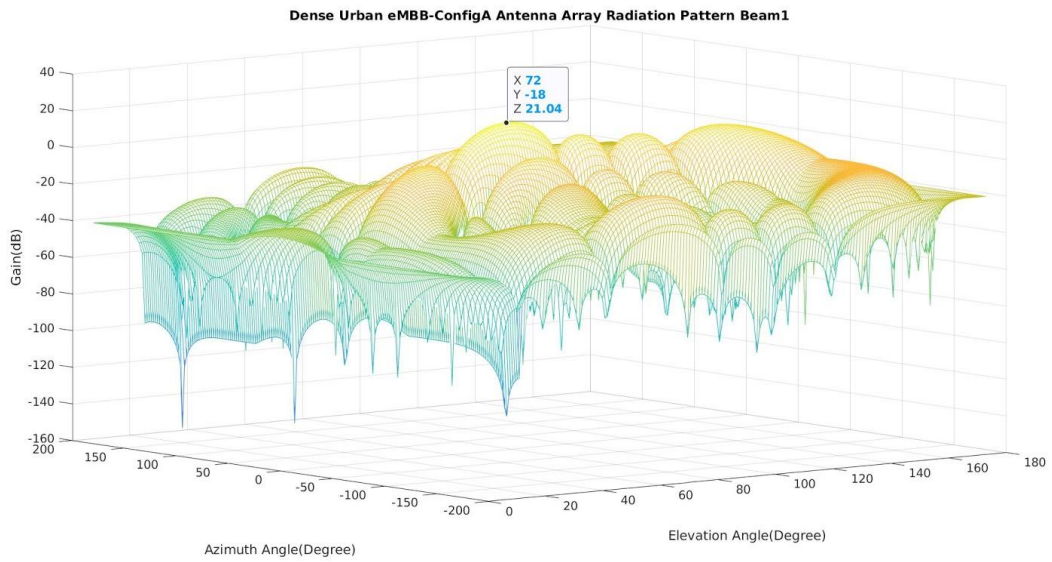



Dense Urban - eMBB

Zenith = 157.5, Azimuth = -56.25

Indoor Hotspot - eMBB

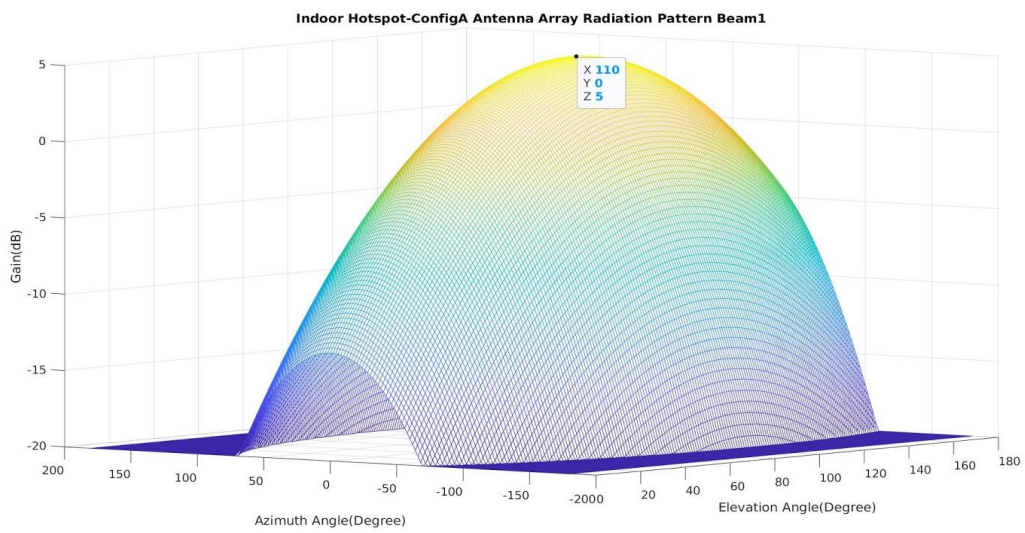

ANNEX C- Calibration Results  
 [Editor Note - System Level Calibration Results]  
 Rural - eMBB

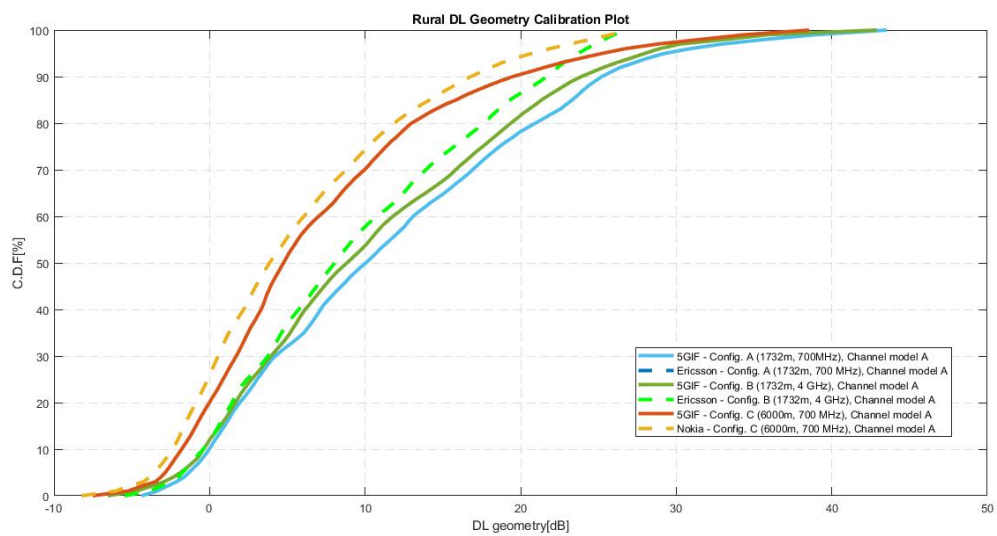
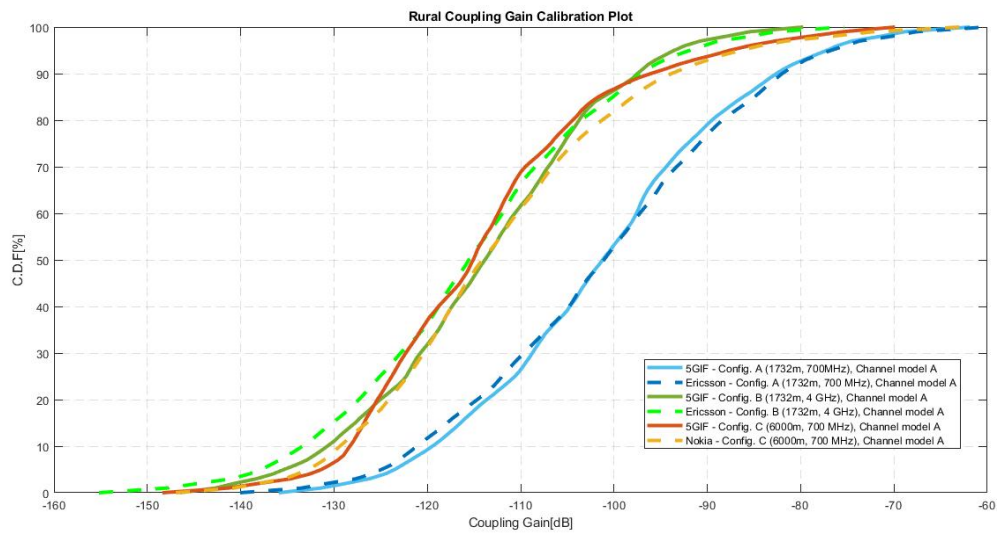

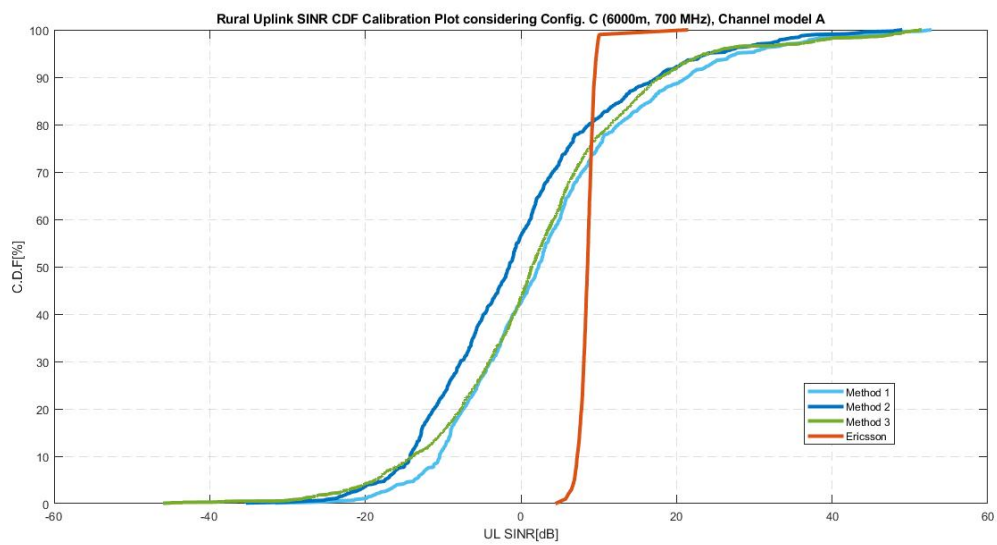
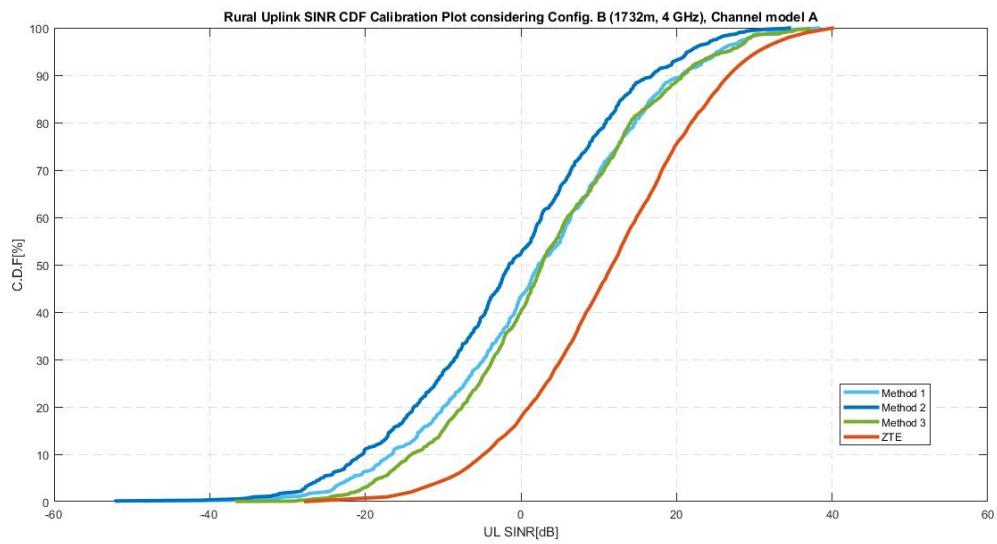
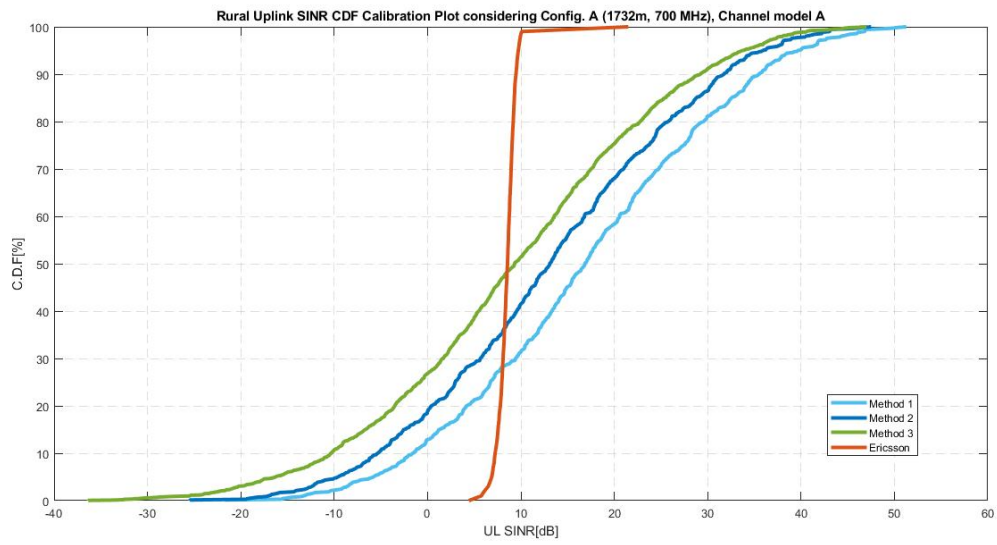

### Dense Urban - eMBB

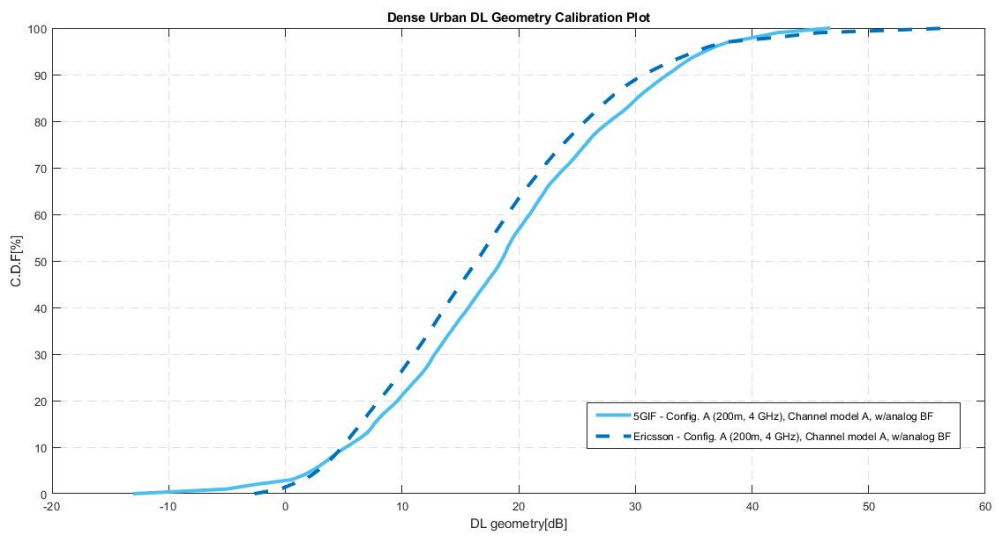
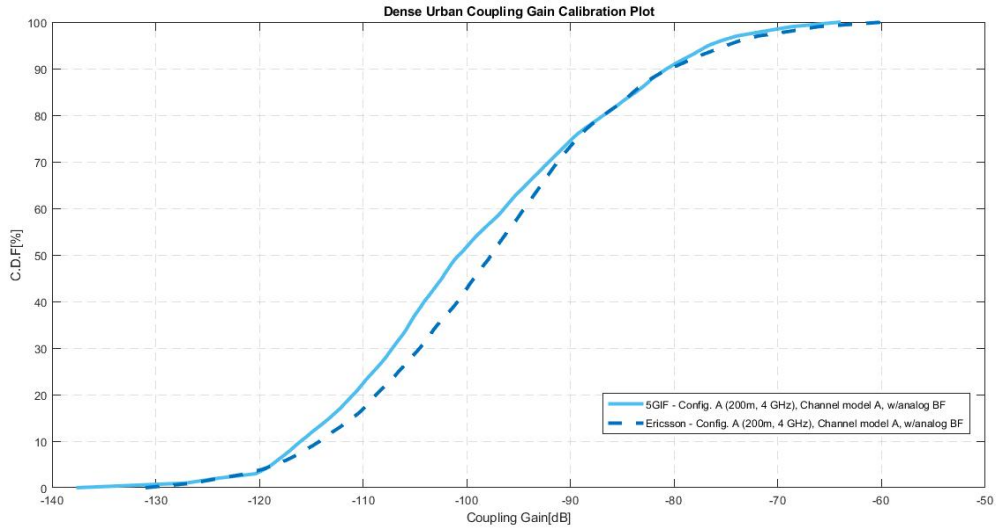

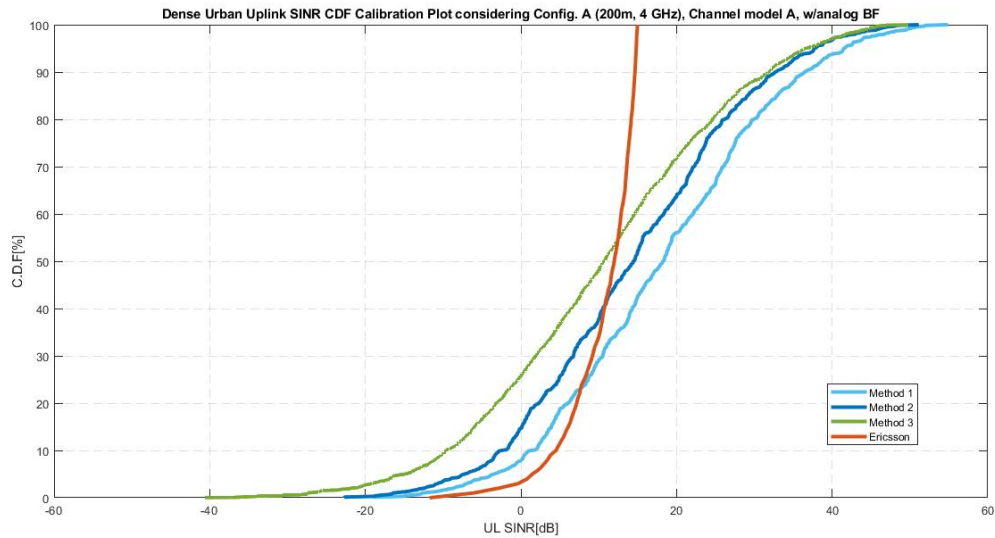

## J. EUHT

### J.1 Analysis on channel coding design

#### Low density parity check coding

##### Base matrix and lifting size

From the check matrix generating procedures the base graph design of the EUHT and 5G-NR is shown in **Table 1** and the sets of 5G-NR LDPC lifting size are shown in **Table 2**

It can be seen that

- 1) the 5G-NR LDPC coding can support more different base matrices sizes and code rate by selecting the part of rows and columns of the base graph1 and base graph 2 flexibly.
- 2) the LDPC coding in NR supports more kinds of information-bit length by selecting different lifting sizes.

**Observation Nu1: LDPC coding in NR can support more kinds of code rate and information-bit length.**

**Table 1 base graph size in 5G-NR and EUHT**

standard	rate	Base graph size	Lifting size(Z)
EUHT	1/2	kb = 8, mb = 8, nb = 16	28
		kb = 12, mb = 12, nb = 24	56
		kb = 12, mb = 12, nb = 24	112
		kb = 24, mb = 24, nb = 48	112
	4/7	kb = 8, mb = 6, nb = 14	32
	5/8	kb = 15, mb = 9, nb = 24	56
		kb = 15, mb = 9, nb = 24	112
		kb = 30, mb = 18, nb = 48	112
	3/4	kb = 18, mb = 6, nb = 24	56
		kb = 18, mb = 6, nb = 24	112
		kb = 36, mb = 12, nb = 48	112
	7/8	kb = 28, mb = 4, nb = 32	42

		kb = 28, mb = 4, nb = 32	84
		kb = 42, mb = 6, nb = 48	112
3GPP 5G-NR	Rmin=1/3	kb = 22, mb = 46, nb = 68	See Table 2
	Rmin=1/5	kb = 10, mb = 42, nb = 52	See Table 2
<p>Note 1: kb is the difference between the size of row and column of the base graph, namely <math>kb=nb-mb</math>, and the information bits <math>K = kb*Z</math>.</p> <p>Note 2: mb is the row size of the base graph.</p> <p>Note 3: nb is the column size of the base graph.</p>			

**Table 2 Sets of LDPC lifting size  $Z$**

Set index ( $i_{LS}$ )	Set of lifting sizes ( $Z$ )
0	{2, 4, 8, 16, 32, 64, 128, 256}
1	{3, 6, 12, 24, 48, 96, 192, 384}
2	{5, 10, 20, 40, 80, 160, 320}
3	{7, 14, 28, 56, 112, 224}
4	{9, 18, 36, 72, 144, 288}
5	{11, 22, 44, 88, 176, 352}
6	{13, 26, 52, 104, 208}
7	{15, 30, 60, 120, 240}

Encoding implement ability

**Observation Nu2:** For LDPC coding in EUHT, quasi cyclic structure of the 7<sup>th</sup> to 10<sup>th</sup> check matrix corresponding to code length  $N=2688$  as shown in Figure 1 may be destroyed by the column-based permutation operation.

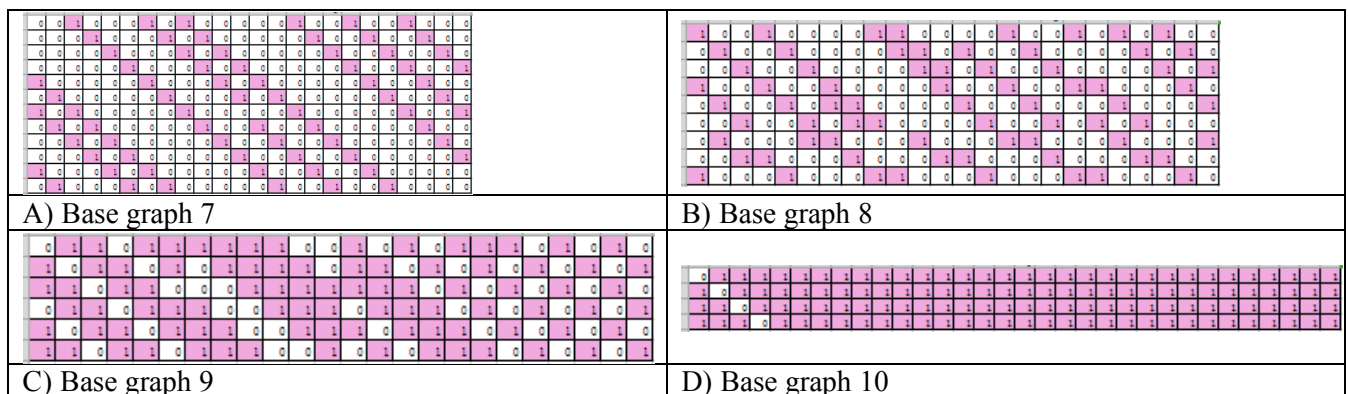

However, for 5G-NR LDPC coding, the information bits are encoded by the base check matrix directly for its row orthogonal, single-diagonal and dual-diagonal characteristics as shown in Figure 2. Therefore, the encoding implement-ability of 5G-NR LDPC coding is much easier than that of EUHT.

**Figure 1 base matrix corresponding to code word length  $N=2688$  of EUHT LDPC coding**



**Figure 2 base matrix of 5G-NR LDPC coding**

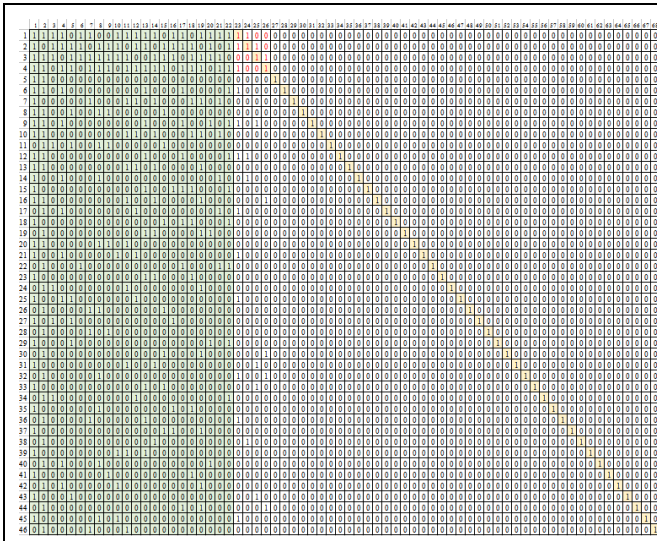

	
A) Base graph 1	B) Base graph 2

### The decoding implement-ability

In EUHT, the base graph selection is determined by the code word length and code rate indicated by control signalling. There are 14 base graphs which supports 14 different information-bit lengths. Obviously, it supports multiple small code blocks in one transmission. However, for the same large data packet, the frame or packet error rate of EUHT LDPC coding may be higher than that of NR LDPC coding.

**Observation Nu3: For the same large data packet, the frame or packet error rate of EUHT LDPC coding may be higher than that of NR LDPC coding.**

### Bit selection

In EUHT, if the channel is coded in the manner of convolutional code, the encoder output code rate is 1/2. A large part of code rate in the MCS table, e.g. 4/7, 5/8, 2/3, 3/4, 5/6 and 7/8 are obtained by puncturing some bits of the code word in a specified puncture pattern. The LDPC code words are not required the puncturing process because of the base graphs with code rate {1/2, 4/7, 5/8, 3/4, 7/8}.

**Observation Nu4: The bit selection procedure of LDPC coding in NR can easily ensure the target spectrum efficiency and lower implementation complexity. And the LDPC coding in EUHT is not required puncturing process.**

### MCS parameter allocation

In EUHT, the SE between each two adjacent MCS entries gap between each two adjacent MCS entries in the MCS table is also the same, for example, the SE of each MCS entry with N<sub>ss</sub>=1 in MCS parameters in EQM mode as shown in **Table 3** is shown as Table A.2 in Appendix.

Furthermore, we run the simulation to show how the required SNR-SE at target BLER=10% changes between LDPC coding in NR and EUHT based on the simulation parameters in **Table 4**. From the curves of SNR-SE @BLER=10% as shown in **Figure 6**, the required SNR at the same BLER=10% increases with the SE of each MCS entries.

**Table 3 MCS parameters in EQM mode in EUHT**

MCS index number	Modulation mode	N <sub>ss</sub>	R	N <sub>BPSC</sub>	SE
0	BPSK	1	1/2	1	0.5
1	QPSK	1	1/2	2	1
2	QPSK	1	3/4	2	1.5

3	16-QAM	1	1/2	4	2
4	16-QAM	1	5/8	4	2.5
5	16-QAM	1	3/4	4	3
6	16-QAM	1	7/8	4	3.5
7	64-QAM	1	2/3	6	4
8	64-QAM	1	3/4	6	4.5
9	64-QAM	1	5/6	6	5
10	64-QAM	1	7/8	6	5.5
11	256-QAM	1	3/4	8	6
12	256-QAM	1	5/6	8	6.67
13	256-QAM	1	7/8	8	7

**Table 4 Simulation parameters**

Attributes	Values or assumptions
Channel model	AWGN
Channel estimation	Ideal
Modulation	BPSK   QPSK   16QAM   64QAM   256QAM   1024QAM
Code rate	See rate values in Table A.2 corresponding to each MCS entries.
Information length(wo CRC)	See K values in Table A.1 corresponding to each code rate.
Coded block size	Information size(wo CRC)/code rate
Target BLER	0.1, 0.01, 0.001
Code construction	BG1 and BG2 in [1] for NR DLPC; BGs in [2] for EUHT.
CRC length	24 bits, 16 bits for LDPC in NR
Decoding algorithm	Min-Sum decoding algorithm with alpha=0.75 BP decoding algorithm
Maximum number of iterations	25 for LDPC coding



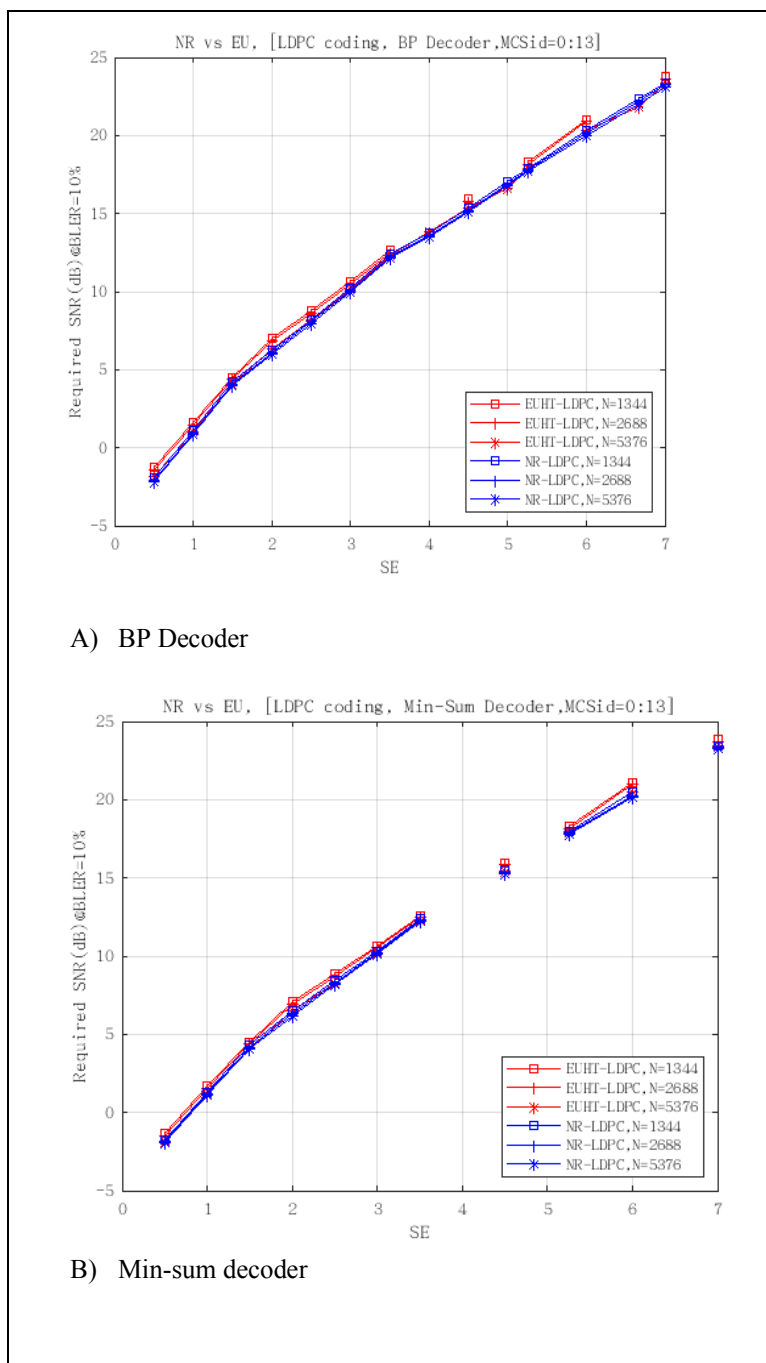

**Figure 6** The required SNR at target BLER=10% for MCS parameters in Table 3

**Observation Nu5:** The required SNR at the same target BLER increases with the MCS entries with the same SE gap between each two adjacent MCS entries.

**Performance evaluation and comparison**

The BLER performances of the LDPC coding in 5G-NR and EUHT are shown in **Figure 7 & 8** and the comparison between the LDPC coding of NR and EUHT are shown as **Table 5**. The required SNR for LDPC coding in NR is lower than that in EUHT, and the difference of the required SNR is almost 0.6~0.7 dB. The difference of the required SNR at the same BLER increases with the code length. Obviously, the BLER performance for LDPC coding in NR is superior than that in EUHT.

**Table 5 Comparison of required SNR at BLER =10% between the 5G-NR LDPC coding and EUHT LDPC coding**

MCS Index	EUHT - NR LDPC BP decoder $\Delta$ SNR(dB)			EUHT - NR LDPC Min-Sum decoder $\Delta$ SNR(dB)		
	BLER=0.1	BLER=0.01	BLER=0.001	BLER=0.1	BLER=0.01	BLER=0.001
0	0.3689	0.3598	0.3246	0.0788	0.072	0.1377
1	0.1835	0.19098	0.18466	0.0924	0.0899	0.0996
2	0.0843	0.0807	0.0684	0.0146	0.0181	0.0228
3	0.3118	0.3167	0.3052	0.2881	0.2812	0.2448
4	0.1818	0.1717	0.1878	0.1366	0.1596	0.1577
5	0.1347	0.148	0.145	0.092	0.089	0.092
6	0.141	0.152	0.145	0.119	0.113	0.119
7	0.3435	0.343	0.3305	0.23	0.246	0.243
8	0.251	0.244	0.246	0.166	0.189	0.179
9	-0.1515	-0.1595	-0.165	-0.217	-0.207	-0.205
10	0.2	0.194	0.179	0.134	0.143	0.158
11	0.319	0.333	0.333	0.276	0.287	0.292
12	-0.176	-0.1615	-0.1715	-0.23	-0.223	-0.218
13	0.241	0.26	0.253	0.179	0.183	0.197
100	0.53704	0.515877	0.49599	0.35986	0.361551	0.373074
101	0.397	0.4149	0.4959	0.3089	0.3165	0.3924
102	0.6667	0.6813	0.6169	0.5358	0.5294	0.5324
103	0.478	0.473	0.48	0.456	0.466	0.467
104	0.293	0.3	0.278	0.222	0.245	0.239
Additional 200	0.439	0.435	0.475	0.44	0.436	0.379
Additional 201	0.518	0.526	0.524	0.534	0.519	0.425
Additional 202	0.788	0.8	0.814	0.856	0.866	0.825

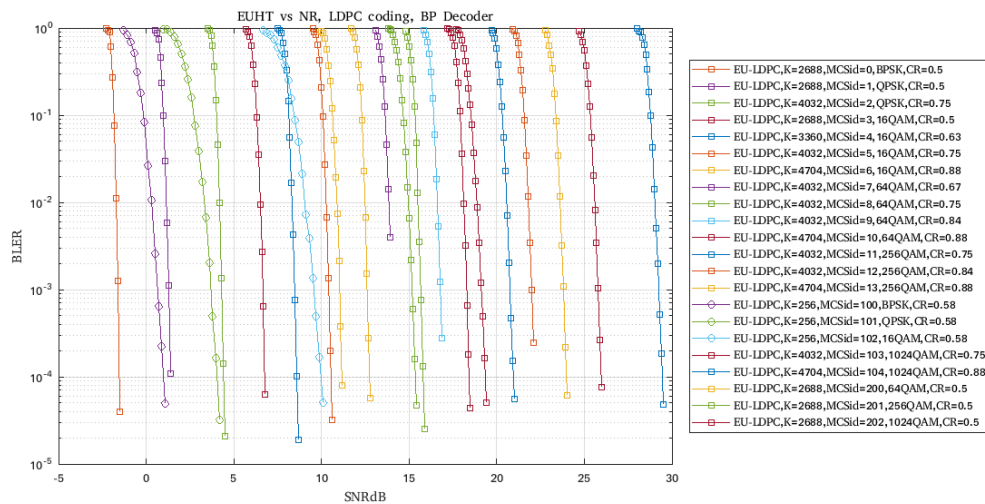

**Figure 7 BLER vs SNR curves for EUHT LDPC coding based on BP decoder**

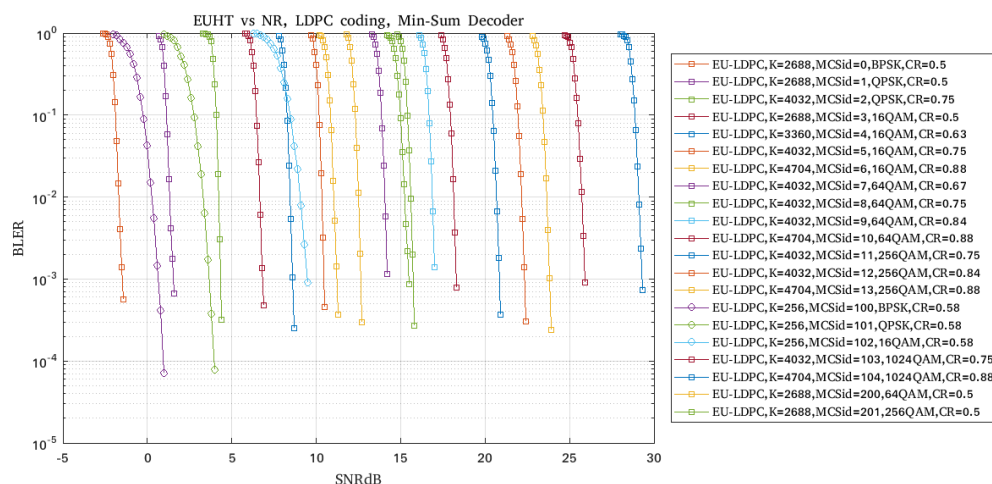

**Figure 8 BLER vs SNR curves for EUHT LDPC coding based on Min-Sum decoder**

**Observation Nu6: From the simulation results in AWGN channel, the BLER performance of EUHT LDPC coding is inferior than that of NR LDPC coding.**

## J.2 Questions

Q1) The EUHT specification mentions three modes of system operation: Normal Mode, Low-Error Mode, and mmWave Mode. The SCS and bandwidth support corresponding to these modes can be inferred from the specification referred (Section 8.1.1). In Section 8.1.1., the mmWave mode is said to support 50, 100, 200, 400 MHz bandwidth. But in accordance with the STA Basic Capability Frame, the maximum support is up to 100 MHz bandwidth at the STA. In our understanding, this limits the achievable capacity. Can this be clarified!

Q2) In the EUHT description template, it mentions support for 1024 QAM, but in the specification Section 6.3.4.4 , the STA Basic Capability indication is limited to 256QAM, “Indication of MCS capability of the STA”. This will impact the results of Peak Spectral Efficiency, Peak Data rate.

Q3) According to EUHT Submission IMT2020/18, the EUHT specification provides a Broadcast Control Frame body format (Section 6.3.4.1) which is used to broadcast CAP capabilities. This format also specifies the three working bandwidth modes at which the CAP broadcasts, but the specification does not seem to provide any information about the bandwidths these bandwidth modes support. Request for clarity on the same.

Q5) Regarding the observations on Downlink & Uplink Guard Interval in IMT2020/27 (Observation of SWG Evaluation (Proponent Nufront) - IMT-2020 submission in Document 5D/1238 (Proponent Nufront)). We also see that there is a inconsistency of the DGI & UGI of 2 symbols with the values used in the self-evaluation by NuFront. The clarification given by NuFront about the bits “b62.... b57” only indicates the start of OFDM symbols for DGI and UGI. We could not find any specification that reduces the DGI & UGI to 1 OFDM symbol duration.

Q6) We noticed that the EUHT specification (through link) shared during the WP5D#32, Brazil has some details on Spectrum Aggregation mode (Section 8.11) , (also attached) which indicated that EUHT has aggregation support only for 78.125 kHz SCS and aggregated system bandwidths 20, 40, 80 MHz (See Figure below), whereas the submission (5D/1300, revised specification attached) in WP5D#33 have deleted those tables and is ambiguous on the spectrum aggregation details, this will impact the capability of the EUHT meeting the TPR - Peak spectral efficiency, Peak Data Rate, User experienced data rate, Bandwidth and support to various services (eMBB).

### 8.11.2.1 Parameters of spectrum aggregation mode

In spectrum aggregation mode, the STA resides on working bandwidth 1. The CAP can independently schedule 20MHz subchannels to transmit in parallel. A 20MHz STA can only be scheduled on one subchannel in one frame for transmission; a working bandwidth 2 STA can schedule one or two sub-channels in one frame for transmission; an working bandwidth 3 STA can schedule one or 2 or 3 or 4 sub-channels in one frame for transmission.

In spectrum aggregation mode, the basic parameters of the working bandwidth 1, 2,3 systems are shown in Table 69.

**Table 69 Spectrum aggregation mode**

System bandwidth	20MHz	40MHz	80MHz
Subcarrier interval in frequency domain	78.125 KHz	78.125 KHz	78.125 KHz
Baseband sampling clock	20MHz	40MHz	80MHz



FFT sample points	256	512	1024
Cyclic Prefix sample points	32	64	128
Number of data subcarriers	224	448	896
Number of phase tracking pilot subcarriers	6	12	24
Number of virtual subcarriers	26	52	104
FFT time window	12.8μs	12.8μs	12.8μs
Cyclic Prefix	1.6μs	1.6μs	1.6μs
OFDM symbol period	14.4μs	14.4μs	14.4μs

In spectrum aggregation mode, four 20MHz subchannels are numbered as subchannel 0, 1, 2, and 3 from low frequency to high. The subcarrier index is shown in Figure 85. The phase tracking pilot subcarrier index of subchannel 0 is -483, -450, -417, -351, -318, -285; of subchannel 1 is -277, -194, -161, -95, -62, -29; of subchannel 2 is 29, 62, 95, 161, 194, 227; of subchannel 3 is 285, 318, 351, 417, 450,

## K. Scenarios and Configurations as per ITU-R M.2412

**Table A Evaluation configurations for Indoor Hotspot-eMBB test environment**

Parameters	Indoor Hotspot-eMBB		
	Spectral Efficiency, Mobility, and Area Traffic Capacity Evaluations		
	Configuration A	Configuration B	Configuration C
<b>Baseline evaluation configuration parameters</b>			
Carrier frequency for evaluation	4 GHz	30 GHz	70 GHz
BS antenna height	3 m	3 m	3 m

Parameters	Indoor Hotspot-eMBB		
	Spectral Efficiency, Mobility, and Area Traffic Capacity Evaluations		
	Configuration A	Configuration B	Configuration C
Total transmit power per TRxP	24 dBm for 20 MHz bandwidth 21 dBm for 10 MHz bandwidth	23 dBm for 80 MHz bandwidth 20 dBm for 40 MHz bandwidth e.i.r.p. should not exceed 58 dBm	21 dBm for 80 MHz bandwidth 18 dBm for 40 MHz bandwidth e.i.r.p. should not exceed 58 dBm
UE power class	23 dBm	23 dBm e.i.r.p. should not exceed 43 dBm	21 dBm e.i.r.p. should not exceed 43 dBm
Additional parameters for system-level simulation			
Inter-site distance	20 m	20 m	20 m
Number of antenna elements per TRxP	Up to 256 Tx/Rx	Up to 256 Tx/Rx	Up to 1024 Tx/Rx
Number of UE antenna elements	Up to 8 Tx/Rx	Up to 32 Tx/Rx	Up to 64 Tx/Rx
Device deployment	100% indoor Randomly and uniformly distributed over the area	100% indoor Randomly and uniformly distributed over the area	100% indoor Randomly and uniformly distributed over the area
UE mobility model	Fixed and identical speed $ v $ of all UEs, randomly and uniformly distributed direction	Fixed and identical speed $ v $ of all UEs, randomly and uniformly distributed direction	Fixed and identical speed $ v $ of all UEs, randomly and uniformly distributed direction
UE speeds of interest	100% indoor, 3 km/h	100% indoor, 3 km/h	100% indoor, 3 km/h
Inter-site interference modelling	Explicitly modelled	Explicitly modelled	Explicitly modelled
BS noise figure	5 dB	7 dB	7 dB
UE noise figure	7 dB	10 dB <sup>16</sup>	10 dB <sup>3</sup>
BS antenna element gain	5 dBi	5 dBi	5 dBi

<sup>16</sup> 10 dB for 30 GHz / 70 GHz is assumed for high performance UE. Higher UE noise figure values can be considered by the proponent, e.g. 13 dB for 30 GHz / 70 GHz.

Parameters	Indoor Hotspot-eMBB		
	Spectral Efficiency, Mobility, and Area Traffic Capacity Evaluations		
	Configuration A	Configuration B	Configuration C
UE antenna element gain	0 dBi	5 dBi	5 dBi
Thermal noise level	-174 dBm/Hz	-174 dBm/Hz	-174 dBm/Hz
Traffic model	Full buffer	Full buffer	Full buffer
Simulation bandwidth	20 MHz for TDD, 10 MHz+10 MHz for FDD	80 MHz for TDD, 40 MHz+40 MHz for FDD	80 MHz for TDD, 40 MHz+40 MHz for FDD
UE density	10 UEs per TRxP randomly and uniformly dropped throughout the geographical area	10 UEs per TRxP randomly and uniformly dropped throughout the geographical area	10 UEs per TRxP randomly and uniformly dropped throughout the geographical area
UE antenna height	1.5 m	1.5 m	1.5 m

Table B Evaluation configurations for Dense Urban-eMBB test environment

Parameters	Dense Urban-eMBB		
	Spectral Efficiency and Mobility Evaluations		User Experienced Data Rate Evaluation
	Configuration A	Configuration B	Configuration C
Baseline evaluation configuration parameters			
Carrier frequency for evaluation	1 layer (Macro) with 4 GHz	1 layer (Macro) with 30 GHz	1 or 2 layers (Macro + Micro). 4 GHz and 30 GHz available in macro and micro layers
BS antenna height	25 m	25 m	25 m for macro sites and 10 m for micro sites

	Dense Urban-eMBB		
	Spectral Efficiency and Mobility Evaluations		User Experienced Data Rate Evaluation
	Configuration A	Configuration B	Configuration C
Total transmit power per TRxP	44 dBm for 20 MHz bandwidth 41 dBm for 10 MHz bandwidth	40 dBm for 80 MHz bandwidth 37 dBm for 40 MHz bandwidth e.i.r.p. should not exceed 73 dBm	Macro 4 GHz: 44 dBm for 20 MHz bandwidth 41 dBm for 10 MHz bandwidth Macro 30 GHz: 40 dBm for 80 MHz bandwidth 37 dBm for 40 MHz bandwidth e.i.r.p. should not exceed 73 dBm Micro 4 GHz: 33 dBm for 20 MHz bandwidth 30 dBm for 10 MHz bandwidth Micro 30 GHz: 33 dBm for 80 MHz bandwidth 30 dBm for 40 MHz bandwidth e.i.r.p. should not exceed 68 dBm

	<b>Dense Urban-eMBB</b>		
	<b>Spectral Efficiency and Mobility Evaluations</b>		<b>User Experienced Data Rate Evaluation</b>
	<b>Configuration A</b>	<b>Configuration B</b>	<b>Configuration C</b>
UE power class	23 dBm	23 dBm, e.i.r.p. should not exceed 43 dBm	4 GHz: 23 dBm 30 GHz: 23 dBm, e.i.r.p. should not exceed 43 dBm
Percentage of high loss and low loss building type	20% high loss, 80% low loss	20% high loss, 80% low loss	20% high loss, 80% low loss
<b>Additional parameters for system-level simulation</b>			
Inter-site distance	200 m	200 m	Macro layer: 200 m (NOTE – Density and layout of Micro layer are in § 8.3)
Number of antenna elements per TRxP	Up to 256 Tx/Rx	Up to 256 Tx/Rx	Up to 256 Tx/Rx
Number of UE antenna elements	Up to 8 Tx/Rx	Up to 32 Tx/Rx	4 GHz: Up to 8 Tx/Rx 30 GHz: Up to 32 Tx/Rx

<b>Parameters</b>	<b>Dense Urban-eMBB</b>		
	<b>Spectral Efficiency and Mobility Evaluations</b>		<b>User Experienced Data Rate Evaluation</b>
	<b>Configuration A</b>	<b>Configuration B</b>	<b>Configuration C</b>
Device deployment	80% indoor, 20% outdoor (in-car) Randomly and uniformly distributed over the area under Macro layer	80% indoor, 20% outdoor (in-car) Randomly and uniformly distributed over the area under Macro layer	80% indoor, 20% outdoor (in-car) Randomly and uniformly distributed over the area under Macro layer
UE mobility model	Fixed and identical speed $ v $ of all UEs of the same mobility class, randomly and uniformly distributed direction.	Fixed and identical speed $ v $ of all UEs of the same mobility class, randomly and uniformly distributed direction.	Fixed and identical speed $ v $ of all UEs of the same mobility class, randomly and uniformly distributed direction.
UE speeds of interest	Indoor users: 3 km/h Outdoor users (in-car): 30 km/h	Indoor users: 3 km/h Outdoor users (in-car): 30 km/h	Indoor users: 3 km/h Outdoor users (in-car): 30 km/h
Inter-site interference modeling	Explicitly modelled	Explicitly modelled	Explicitly modelled
BS noise figure	5 dB	7 dB	4 GHz: 5 dB 30 GHz: 7 dB

Parameters	Dense Urban-eMBB		
	Spectral Efficiency and Mobility Evaluations		User Experienced Data Rate Evaluation
	Configuration A	Configuration B	Configuration C
UE noise figure	7 dB	10 dB <sup>17</sup>	4 GHz: 7 dB 30 GHz: 10 dB <sup>4</sup>
BS antenna element gain	8 dBi	8 dBi	4 GHz: 8 dBi 30 GHz: Macro TRxP: 8 dBi
UE antenna element gain	0 dBi	5 dBi	4 GHz: 0 dBi 30 GHz: 5 dBi
Thermal noise level	-174 dBm/Hz	-174 dBm/Hz	-174 dBm/Hz
Traffic model	Full buffer	Full buffer	Full buffer
Simulation bandwidth	20 MHz for TDD, 10 MHz+10 MHz for FDD	80 MHz for TDD, 40 MHz+40 MHz for FDD	4 GHz: 20 MHz for TDD, 10 MHz+10 MHz for FDD 30 GHz: 80 MHz for TDD, 40 MHz+40 MHz for FDD

Parameters	Dense Urban-eMBB		
	Spectral Efficiency and Mobility Evaluations		User Experienced Data Rate Evaluation
	Configuration A	Configuration B	Configuration C
UE density	10 UEs per TRxP Randomly and uniformly distributed over the area under Macro layer	10 UEs per TRxP Randomly and uniformly distributed over the area under Macro layer	10 UEs per TRxP for multi-layer case, randomly and uniformly dropped within a cluster. The proponent reports the size of the cluster
UE antenna height	Outdoor UEs: 1.5 m Indoor UTs: $3(n_{fl} - 1) + 1.5$ ; $n_{fl} \sim \text{uniform}(1, N_{fl})$ where $N_{fl} \sim \text{uniform}(4, 8)$	Outdoor UEs: 1.5 m Indoor UTs: $3(n_{fl} - 1) + 1.5$ ; $n_{fl} \sim \text{uniform}(1, N_{fl})$ where $N_{fl} \sim \text{uniform}(4, 8)$	Outdoor UEs: 1.5 m Indoor UTs: $3(n_{fl} - 1) + 1.5$ ; $n_{fl} \sim \text{uniform}(1, N_{fl})$ where $N_{fl} \sim \text{uniform}(4, 8)$

Table C Evaluation configurations for Rural-eMBB test environment

Parameters	Rural-eMBB		
	Spectral Efficiency and Mobility Evaluations		Average Spectral Efficiency Evaluation
	Configuration A	Configuration B	Configuration C (LMLC)
<b>Baseline evaluation configuration parameters</b>			
Carrier frequency for evaluation	700 MHz	4 GHz	700 MHz
BS antenna height	35 m	35 m	35 m

<sup>17</sup> 10 dB for 30 GHz is assumed for high performance UE. Higher UE noise figure values can be considered by the proponent, e.g. 13 dB for 30 GHz.



Total transmit power per TRxP	49 dBm for 20 MHz bandwidth 46 dBm for 10 MHz bandwidth	49 dBm for 20 MHz bandwidth 46 dBm for 10 MHz bandwidth	49 dBm for 20 MHz bandwidth 46 dBm for 10 MHz bandwidth
UE power class	23 dBm	23 dBm	23 dBm
Percentage of high loss and low loss building type	100% low loss	100% low loss	100% low loss
<b>Additional parameters for system-level simulation</b>			
Inter-site distance	1732 m	1732 m	6000 m
Number of antenna elements per TRxP	Up to 64 Tx/Rx	Up to 256 Tx/Rx	Up to 64 Tx/Rx
Number of UE antenna elements	Up to 4 Tx/Rx	Up to 8 Tx/Rx	Up to 4 Tx/Rx

Parameters	Rural-eMBB		
	Spectral Efficiency and Mobility Evaluations		Average Spectral Efficiency Evaluation
	Configuration A	Configuration B	Configuration C (LMLC)
Device deployment	50% indoor, 50% outdoor (in-car) Randomly and uniformly distributed over the area	50% indoor, 50% outdoor (in-car) Randomly and uniformly distributed over the area	40% indoor, 40% outdoor (pedestrian), 20% outdoor (in-car) Randomly and uniformly distributed over the area
UE mobility model	Fixed and identical speed $ v $ of all UEs, randomly and uniformly distributed direction	Fixed and identical speed $ v $ of all UEs, randomly and uniformly distributed direction	Fixed and identical speed $ v $ of all UEs, randomly and uniformly distributed direction
UE speeds of interest	Indoor users: 3 km/h; Outdoor users (in-car): 120 km/h; 500 km/h for evaluation of mobility in high-speed case	Indoor users: 3 km/h; Outdoor users (in-car): 120 km/h; 500 km/h for evaluation of mobility in high-speed case	Indoor users: 3 km/h; Outdoor users (pedestrian): 3 km/h; Outdoor users (in-car): 30 km/h
Inter-site interference modeling	Explicitly modelled	Explicitly modelled	Explicitly modelled
BS noise figure	5 dB	5 dB	5 dB
UE noise figure	7 dB	7 dB	7 dB
BS antenna element gain	8 dBi	8 dBi	8 dBi
UE antenna element gain	0 dBi	0 dBi	0 dBi
Thermal noise level	-174 dBm/Hz	-174 dBm/Hz	-174 dBm/Hz
Traffic model	Full buffer	Full buffer	Full buffer
Simulation bandwidth	20 MHz for TDD, 10 MHz+10 MHz for FDD	20 MHz for TDD, 10 MHz+10 MHz for FDD	20 MHz for TDD, 10 MHz+10 MHz for FDD
UE density	10 UEs per TRxP Randomly and uniformly distributed over the area	10 UEs per TRxP Randomly and uniformly distributed over the area	10 UEs per TRxP Randomly and uniformly distributed over the area
UE antenna height	1.5 m	1.5 m	1.5 m

Table D : Evaluation configurations for Urban Macro-mMTC test environments

Parameters	Urban Macro-mMTC	
	Connection Density Evaluation	
	Configuration A	Configuration B
<b>Baseline evaluation configuration parameters</b>		
Carrier frequency for evaluation	700 MHz	700 MHz
BS antenna height	25 m	25 m
Total transmit power per TRxP <sup>18</sup>	49 dBm for 20 MHz bandwidth 46 dBm for 10 MHz bandwidth	49 dBm for 20 MHz bandwidth 46 dBm for 10 MHz bandwidth

<sup>18</sup> This/these parameter(s) is/are used for cell association.

Parameters	Urban Macro–mMTC	
	Connection Density Evaluation	
	Configuration A	Configuration B
UE power class	23 dBm	23 dBm
Percentage of high loss and low loss building type	20% high loss, 80% low loss	20% high loss, 80% low loss
Additional parameters for system-level simulation		
Inter-site distance	500 m	1732 m
Number of antenna elements per TRxP	Up to 64 Tx/Rx	Up to 64 Tx/Rx
Number of UE antenna elements	Up to 2 Tx/Rx	Up to 2 Tx/Rx
Device deployment	80% indoor, 20% outdoor Randomly and uniformly distributed over the area	80% indoor, 20% outdoor Randomly and uniformly distributed over the area
UE mobility model	Fixed and identical speed $ v $ of all UEs of the same mobility class, randomly and uniformly distributed direction.	Fixed and identical speed $ v $ of all UEs of the same mobility class, randomly and uniformly distributed direction.
UE speeds of interest	3 km/h for indoor and outdoor	3 km/h for indoor and outdoor
Inter-site interference modelling	Explicitly modelled	Explicitly modelled
BS noise figure	5 dB	5 dB
UE noise figure	7 dB	7 dB
BS antenna element gain	8 dBi	8 dBi
UE antenna element gain	0 dBi	0 dBi
Thermal noise level	-174 dBm/Hz	-174 dBm/Hz

Table E: Evaluation configurations for Urban Macro-mMTC test environments

Parameters	Urban Macro–mMTC	
	Connection Density Evaluation	
	Configuration A	Configuration B
Traffic model	With layer 2 PDU (Protocol Data Unit) message size of 32 bytes: 1 message/day/device or 1 message/2 hours/device <sup>19</sup> Packet arrival follows Poisson arrival process for non-full buffer system-level simulation	With layer 2 PDU (Protocol Data Unit) message size of 32 bytes: 1 message/day/device or 1 message/2 hours/device <sup>6</sup> Packet arrival follows Poisson arrival process for non-full buffer system-level simulation
Simulation bandwidth	Up to 10 MHz	Up to 50 MHz
UE density	Not applicable for non-full buffer system-level simulation as evaluation methodology of connection density For full buffer system-level simulation followed by link-level simulation, 10 UEs per TRxP NOTE – this is used for SINR CDF distribution derivation	Not applicable for non-full buffer system-level simulation as evaluation methodology of connection density For full buffer system-level simulation followed by link-level simulation, 10 UEs per TRxP NOTE – this is used for SINR CDF distribution derivation
UE antenna height	1.5m	1.5 m

Table F Evaluation configurations for Urban Macro-URLLC test environments

Parameters	Urban Macro–URLLC	
	Reliability Evaluation	
	Configuration A	Configuration B
<b>Baseline evaluation configuration parameters</b>		
Carrier frequency for evaluation	4 GHz	700 MHz
BS antenna height	25 m	25 m
Total transmit power per TRxP	49 dBm for 20 MHz bandwidth 46 dBm for 10 MHz bandwidth	49 dBm for 20 MHz bandwidth 46 dBm for 10 MHz bandwidth
UE power class	23 dBm	23 dBm
Percentage of high loss and low loss building type	100% low loss	100% low loss

<sup>19</sup> Higher traffic loads are encouraged.  
COAI-5GIF

Table G Evaluation configurations for Urban Macro-URLLC test environments

Parameters	Urban Macro-URLLC	
	Reliability Evaluation	
	Configuration A	Configuration B
<b>Additional parameters for system-level simulation</b>		
Inter-site distance	500 m	500 m
Number of antenna elements per TRxP <sup>1</sup>	Up to 256 Tx/Rx	Up to 64 Tx/Rx
Number of UE antenna elements	Up to 8 Tx/Rx	Up to 4 Tx/Rx
Device deployment	80% outdoor, 20% indoor	80% outdoor, 20% indoor
UE mobility model	Fixed and identical speed $ v $ of all UEs, randomly and uniformly distributed direction	Fixed and identical speed $ v $ of all UEs, randomly and uniformly distributed direction
UE speeds of interest	3 km/h for indoor and 30 km/h for outdoor	3 km/h for indoor and 30 km/h for outdoor
Inter-site interference modelling	Explicitly modelled	Explicitly modelled
BS noise figure	5 dB	5 dB
UE noise figure	7 dB	7 dB
BS antenna element gain	8 dBi	8 dBi
UE antenna element gain	0 dBi	0 dBi
Thermal noise level	-174 dBm/Hz	-174 dBm/Hz
Traffic model	Full buffer NOTE – This is used for SINR CDF distribution derivation	Full buffer NOTE – This is used for SINR CDF distribution derivation
Simulation bandwidth	Up to 100 MHz NOTE – This value is used for SINR CDF distribution derivation	Up to 40 MHz NOTE – This value is used for SINR CDF distribution derivation
UE density	10 UEs per TRxP NOTE – This is used for SINR CDF distribution derivation	10 UEs per TRxP NOTE – This is used for SINR CDF distribution derivation
UE antenna height	1.5 m	1.5 m